

GUARDIAN D63

(DM-GY179)

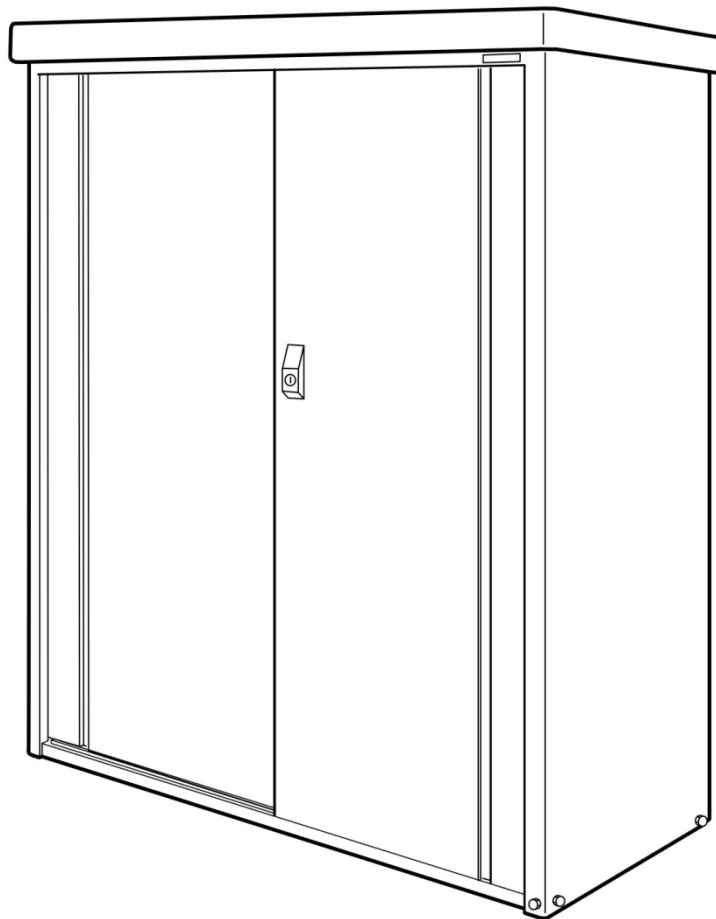

GB	ASSEMBLY INSTRUCTION
F	
D	
NL	
I	
S	
DK	
N	

PARTS DETAIL

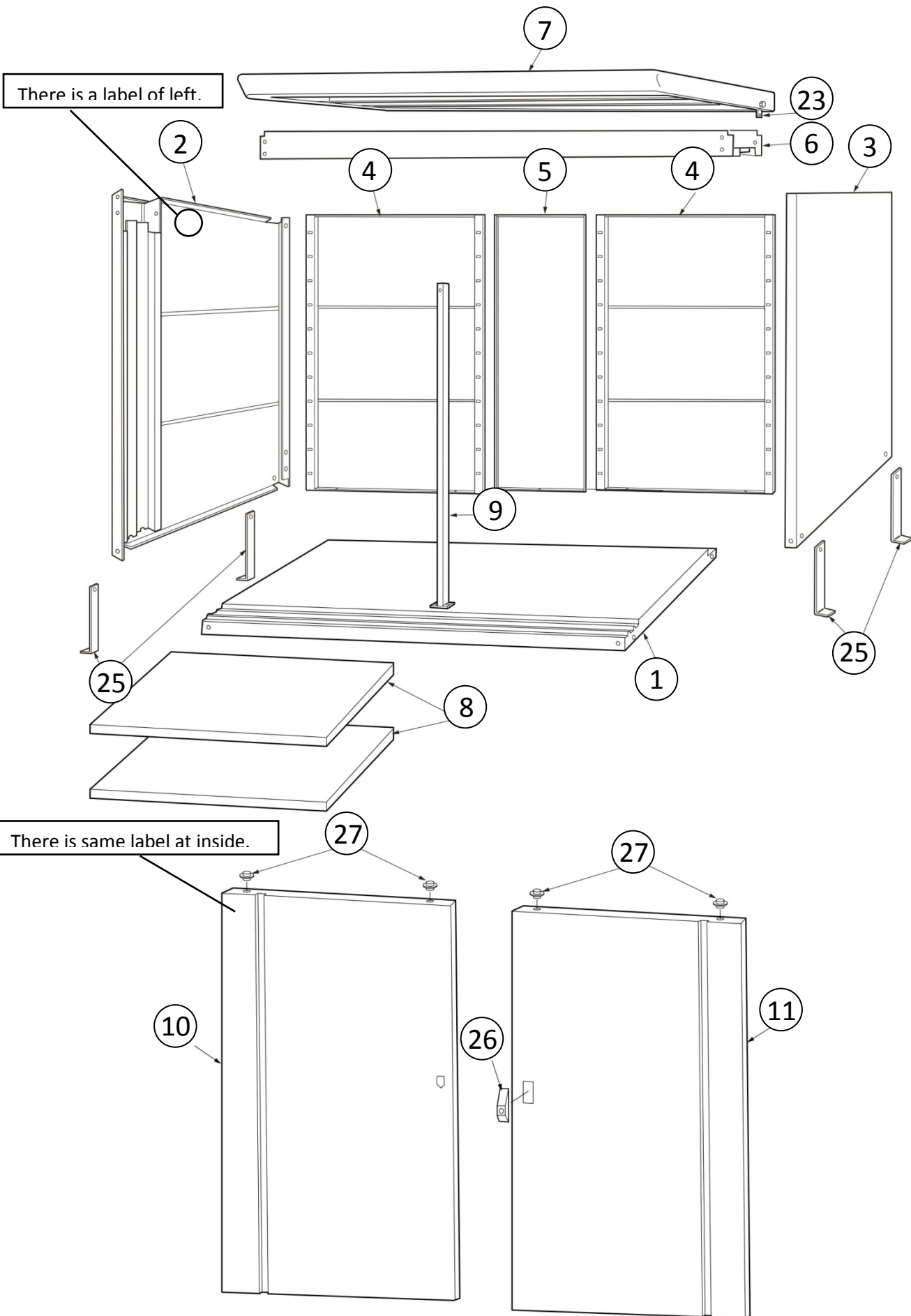

PACKING DETAIL

PACKING NO.	PACKING NAME	PART NO & DESCRIPTION		QTY
M9-0105	BEAM		PARTS	1
		6	BEAM	1
M9-0207	METAL BASE	1	METAL BASE	1
M9-0302	SIDE PANELS (RIGHT & LEFT)	3	SIDE PANEL (Right)	1
		2	SIDE PANEL (Left)	1
		5	BACK PANEL (Small)	1
		9	SHELF SUPPORT	1
M9-0405	BACK PANEL	4	BACK PANEL (Large)	2
M9-0507	ROOF PANEL & SHELVES	7	ROOF PANEL	1
		8	SHELF	2
M9-0605	SLIDING DOORS (RIGHT & LEFT)	11	SLIDING DOOR (Right)	1
		10	SLIDING DOOR (Left)	1

PACKING NO.	PACKING NAME	PART NO & DESCRIPTION		QTY
M9-0105				1
		6		1
M9-0207		1		1
M9-0302		3		1
		2		1
		5		1
		9		1
M9-0405		4		2
M9-0507		7		1
		8		2
M9-0605		11		1
		10		1

PACKING NO.	PACKING NAME	PART NO & DESCRIPTION		QTY
M9-0105				1
		6		1
M9-0207		1		1
M9-0302		3		1
		2		1
		5		1
		9		1
M9-0405		4		2
M9-0507		7		1
		8		2
M9-0605		11		1
		10		1

PACKING NO.	PACKING NAME	PART NO & DESCRIPTION		QTY
M9-0105				1
		6		1
M9-0207		1		1
M9-0302		3		1
		2		1
		5		1
		9		1
M9-0405		4		2
M9-0507		7		1
		8		2
M9-0605		11		1
		10		1









PACKING NO.	PACKING NAME	PART NO & DESCRIPTION		QTY
M9-0105				1
		6		1
M9-0207		1		1
M9-0302		3		1
		2		1
		5		1
		9		1
M9-0405		4		2
M9-0507		7		1
		8		2
M9-0605		11		1
		10		1









PACKING NO.	PACKING NAME	PART NO & DESCRIPTION		QTY
M9-0105				1
		6		1
M9-0207		1		1
M9-0302		3		1
		2		1
		5		1
		9		1
M9-0405		4		2
M9-0507		7		1
		8		2
M9-0605		11		1
		10		1









PACKING NO.	PACKING NAME	PART NO & DESCRIPTION		QTY
M9-0105				1
		6		1
M9-0207		1		1
M9-0302		3		1
		2		1
		5		1
		9		1
M9-0405		4		2
M9-0507		7		1
		8		2
M9-0605		11		1
		10		1









PACKING NO.	PACKING NAME	PART NO & DESCRIPTION		QTY
M9-0105				1
		6		1
M9-0207		1		1
M9-0302		3		1
		2		1
		5		1
		9		1
M9-0405		4		2
M9-0507		7		1
		8		2
M9-0605		11		1
		10		1









PACKING DETAIL *CONT.*









PART NO.	DESCRIPTION	PART DRAWING	QTY
21	HEXAGON BOLTS (M6)		35 (1 SPARE)
22	HEXAGON BOLTS (M6) WITH RUBBER WASHER		12
23	WALL ANCHOR POINT		2
24	SHELF BRACKET		8
25	L SHAPED ANCHOR BRACKET		4
26	LOCK SET		1
27	DOOR GUIDE		4
28	PLASTIC BOLT COVER		12











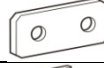

PART NO.	DESCRIPTION	PART DRAWING	QTY
21			35 (1 SPARE)
22			12
23			2
24			8
25			4
26			1
27			4
28			12

PART NO.	DESCRIPTION	PART DRAWING	QTY
21			35 (1 SPARE)
22			12
23			2
24			8
25			4
26			1
27			4
28			12

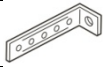
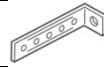
PART NO.	DESCRIPTION	PART DRAWING	QTY
21			35 (1 SPARE)
22			12
23			2
24			8
25			4
26			1
27			4
28			12

PART NO.	DESCRIPTION	PART DRAWING	QTY
22			35 (1 SPARE)
23			12
24			2
25			8
26			4
27			1
28			4
21			12

PART NO.	DESCRIPTION	PART DRAWING	QTY
21			35 (1 SPARE)
22			12
23			2
24			8
25			4
26			1
27			4
28			12

PART NO.	DESCRIPTION	PART DRAWING	QTY	PART NO.	DESCRIPTION	PART DRAWING	QTY
22			35 (1 SPARE)	22			35 (1 SPARE)
23			12	23			12
24			2	24			2
25			8	25			8
26			4	26			4
27			1	27			1
28			4	28			4
21			12	21			12

TOOLS REQUIRED

PHILIPS SCREWDRIVER
SPIRIT LEVEL

RECOMMENDED TOOLS:
ELECTRIC SCREWDRIVER*
8MM SOCKET BIT

*WHEN USING AN ELECTRIC SCREWDRIVER, PLEASE TAKE CARE NOT TO OVER TIGHTEN BOLTS

DIMENSIONS

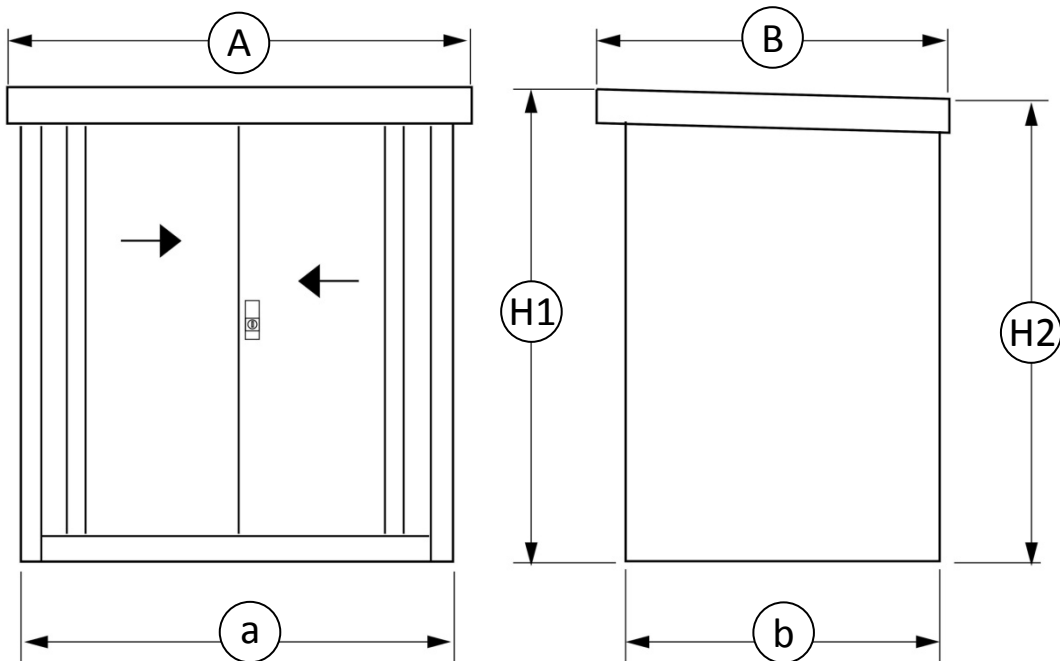

	A	B	a	b	H1	H2
GUARDIAN D63	1760mm	980mm	1720mm	900mm	1865mm	1850mm

STEP 1 - Metal Base Installation

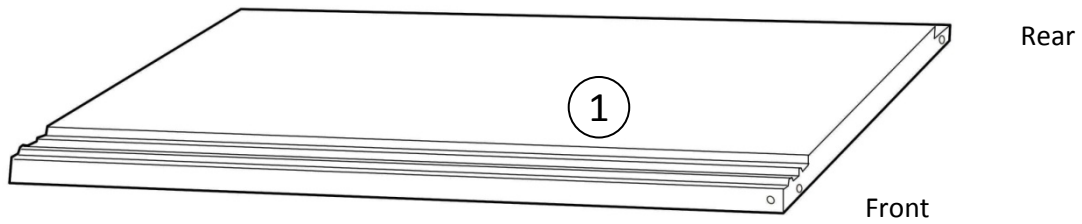

Figure 1.

(GB)

Ensure the assembly site is flat and level. Identify [Part 1] Metal Base

(F)

(D)

(NL)

(I)

(S)

(DK)

(N)

STEP 2 - Side Panel Installation

Figure 2.

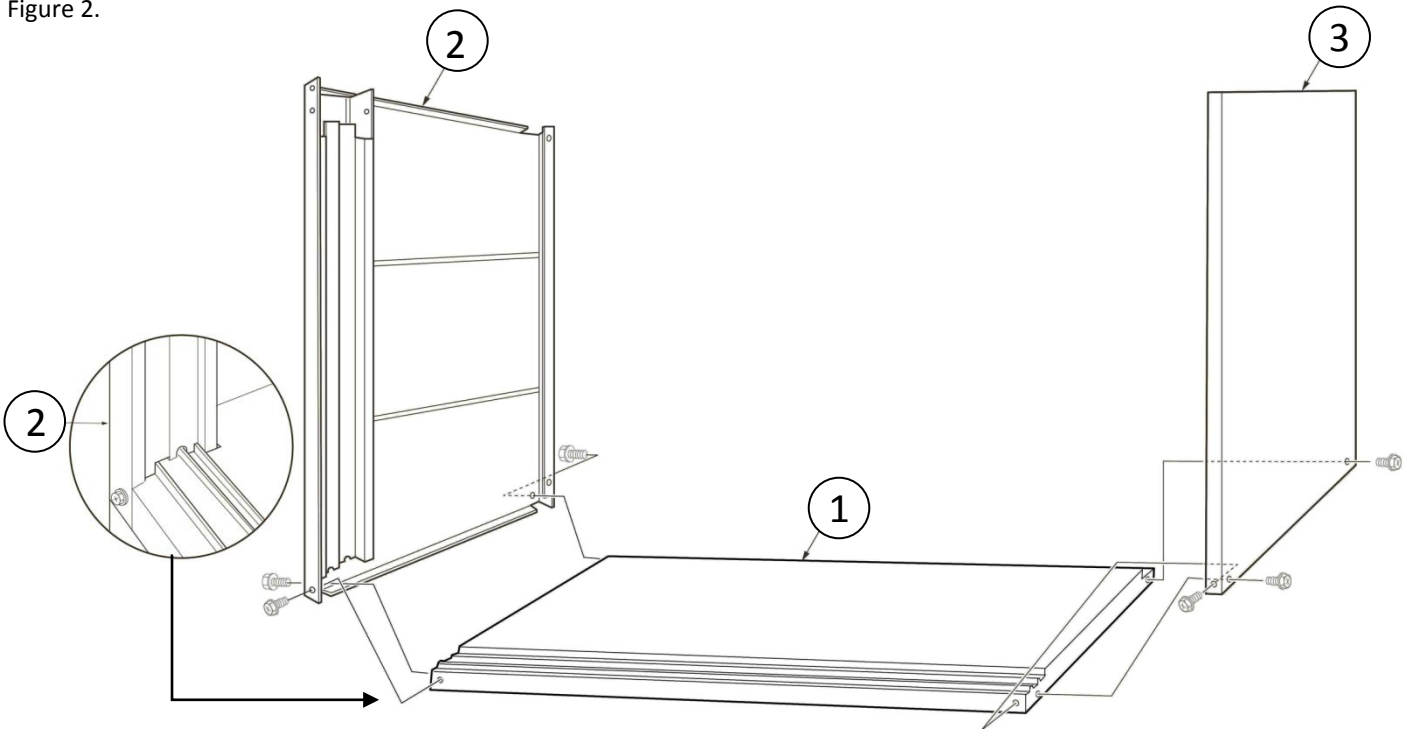

(GB)

Slot [Part 2] & [Part 3] Side Panels on to the [Part 1] Metal Base and secure using 6no. [Part 21] Hexagon Bolt as shown in Figure 2 and 3.

(F)

(D)

(NL)

(I)

(S)

(DK)

(N)

Step 3 - Install Back Panel (Large)



Top View: Back Panel (Large)

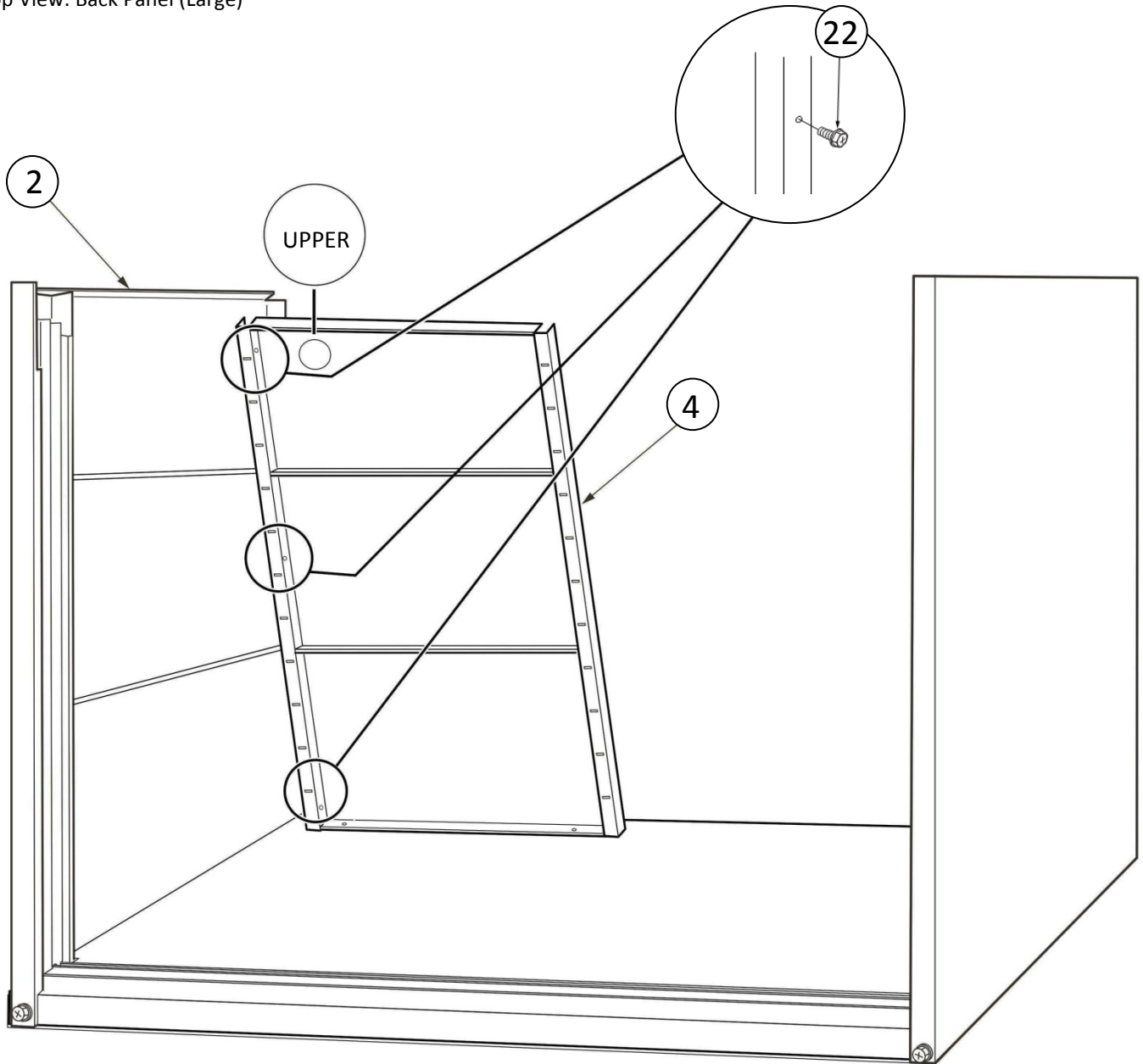

Figure 3.

(GB) Combine [Part 4] Back Panel (Large) with [Part 2] Side Panel (Left) and secure using 3no. [Part 22] Hexagon Bolt with Rubber Washer as shown in Figure 3.

(F)

(D)

(NL)

(I)

(S)

(DK)

(N)

STEP 4 - Secure Back Panel (Large) to Metal Base

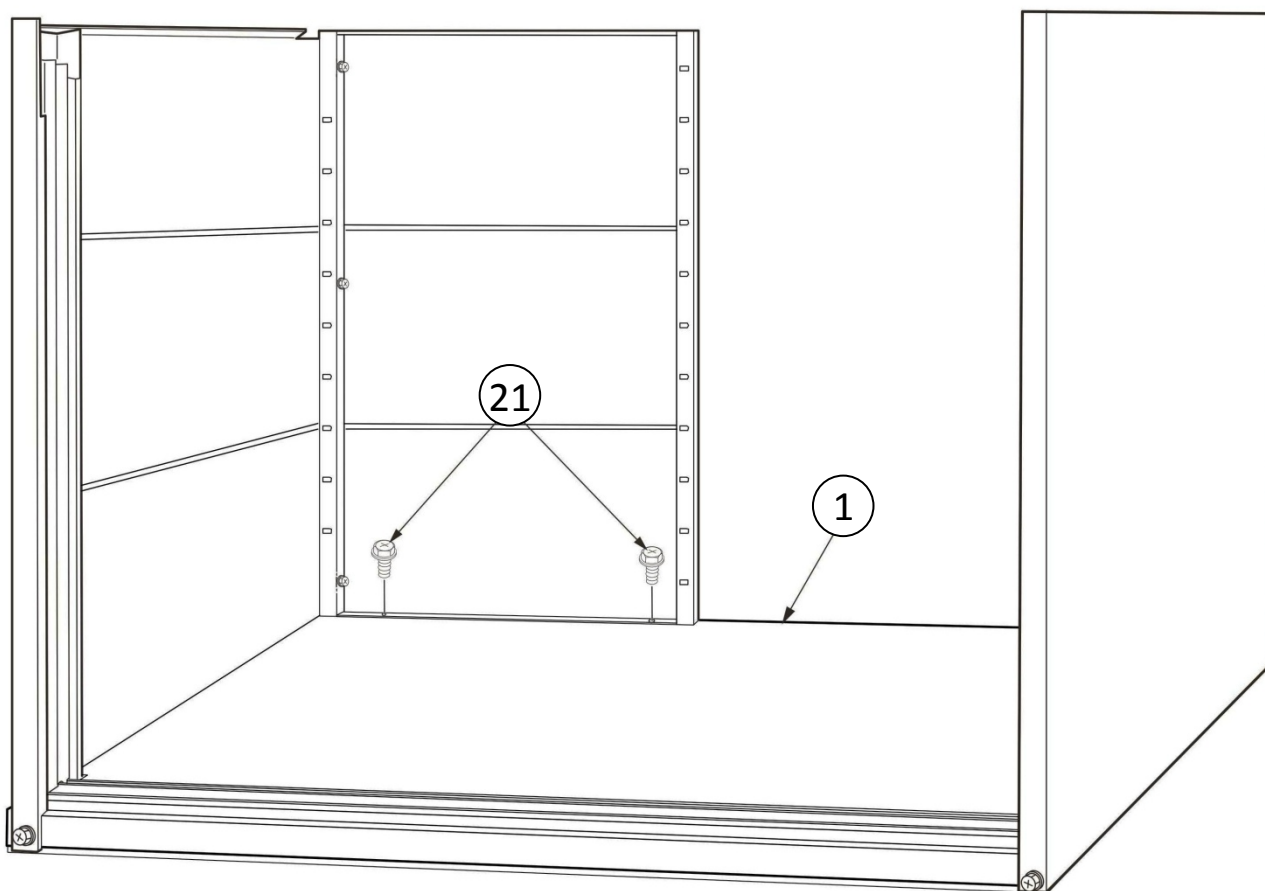
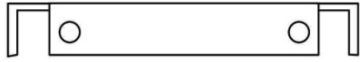

Figure 4.

(GB)	Secure [Part 4] Back Panel (Large) to [Part 1] Metal Base using 2no. [Part 21] Hexagon Bolt as shown in Figure 4.
(F)	
(D)	
(NL)	
(I)	
(S)	
(DK)	
(N)	

STEP 5 - Install Back Panel (Small)



Top View: Back Panel (Small)

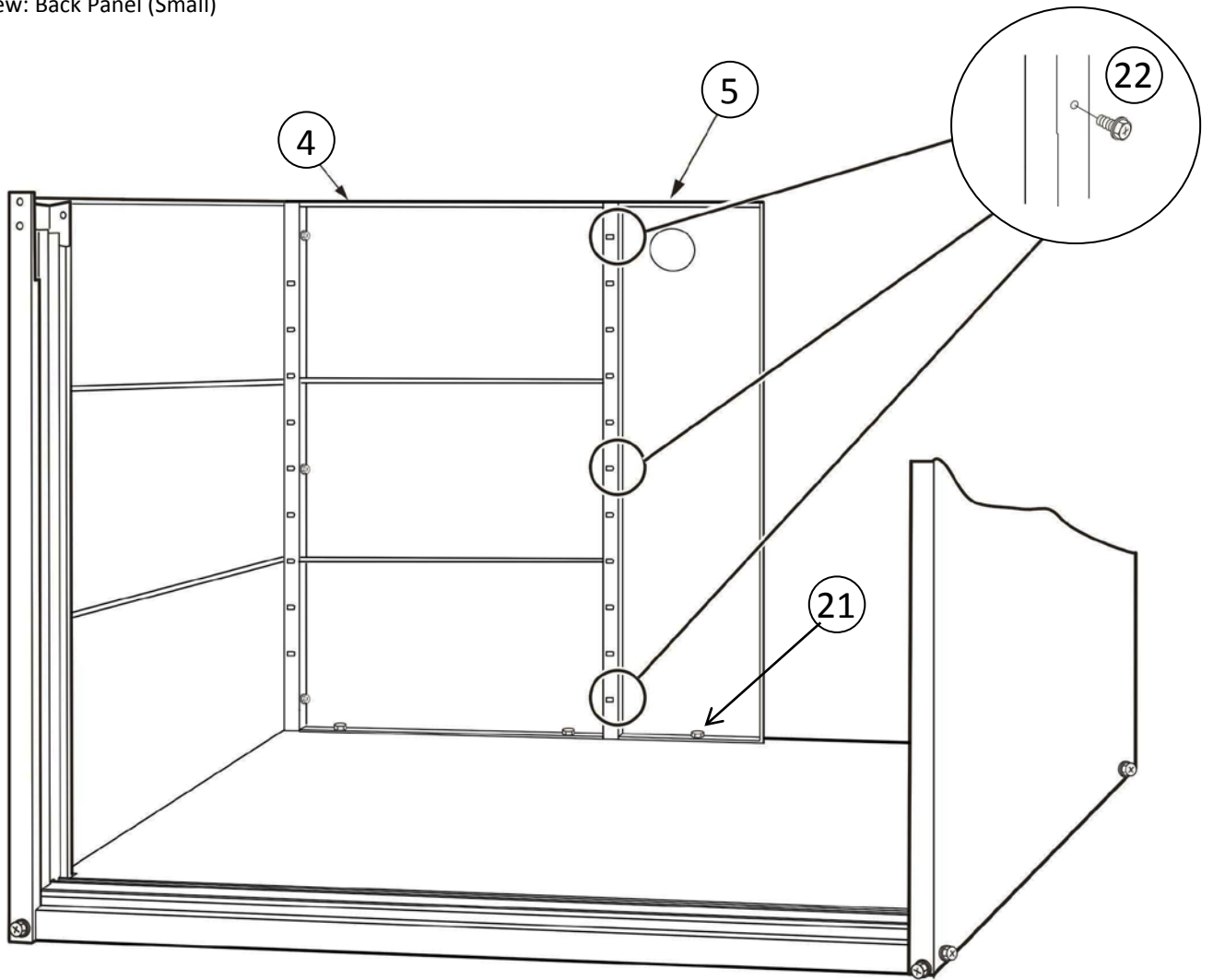

Figure 5.

(GB)

Combine [Part 5] Back Panel (Small) with [Part 4] Back Panel (Large) and secure using 3no. [Part 22] Hexagon Bolt with Rubber Washer. Secure [Part 5] Back Panel (Small) to [Part 1] Metal Base using 2no. [Part 21] Hexagon Bolt. Shown in Figure 5.

(F)

(D)

(NL)

(I)

(S)

(DK)

(N)

STEP 6 - Install Back Panel (Large)

Figure 6.

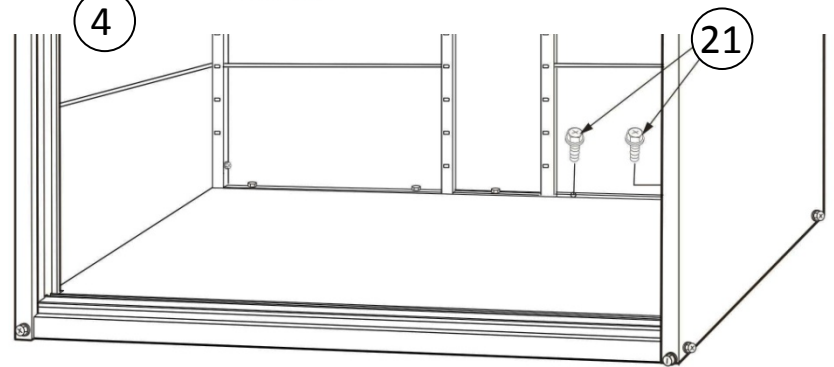
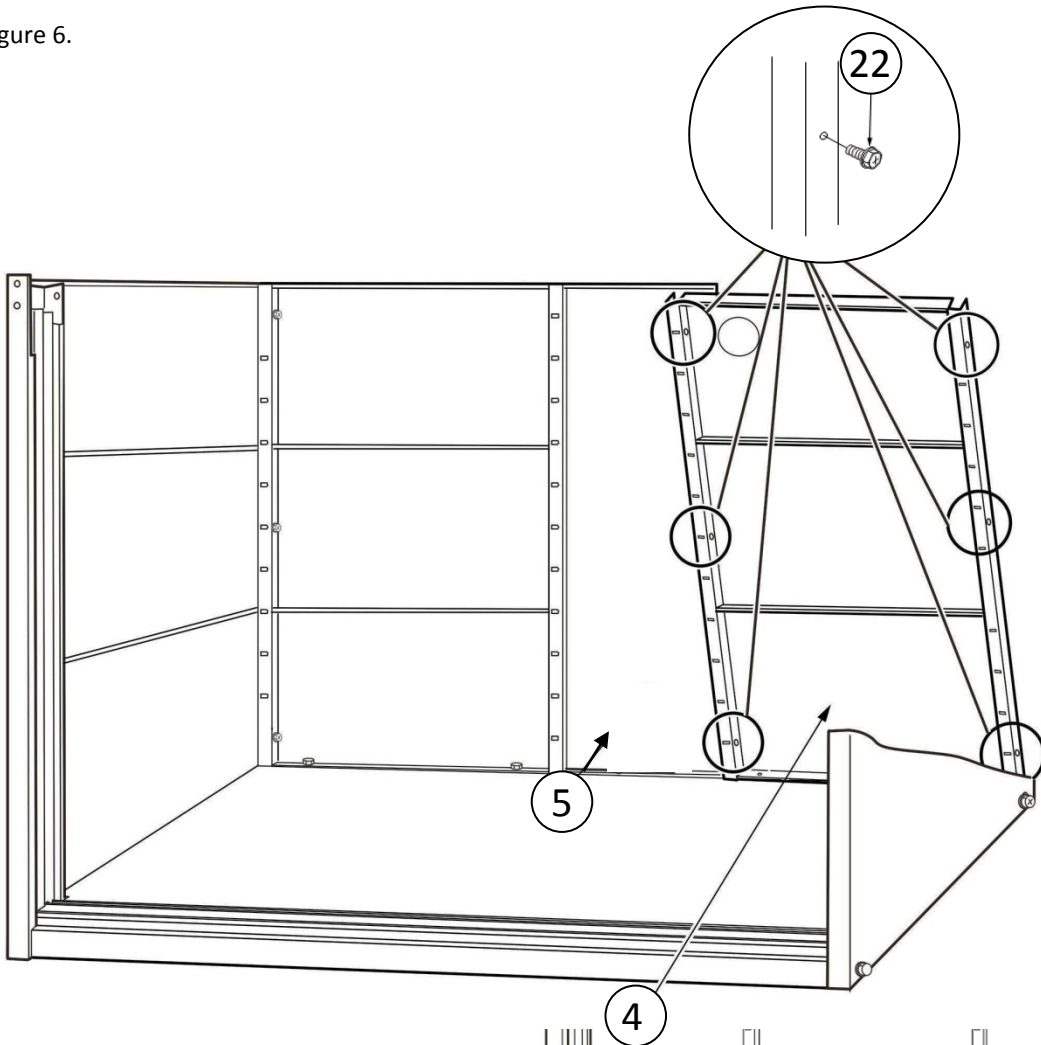

Figure 7.

(GB)

Combine [Part 4] Back Panel (Large) with [Part 5] Back Panel (Small) and [Part 3] Side Panel (Right). Secure using 6no. [Part 22] Hexagon Bolt with Rubber Washer as shown in Figure 6. Secure [Part 4] Back Panel (Large) to [Part 1] Metal Base using 2no. [Part 21] Hexagon Bolt as shown in Figure 7.

(F)

(D)

(NL)

(I)

(S)

(DK)

(N)

STEP 7 - Install Beam and Shelf Support

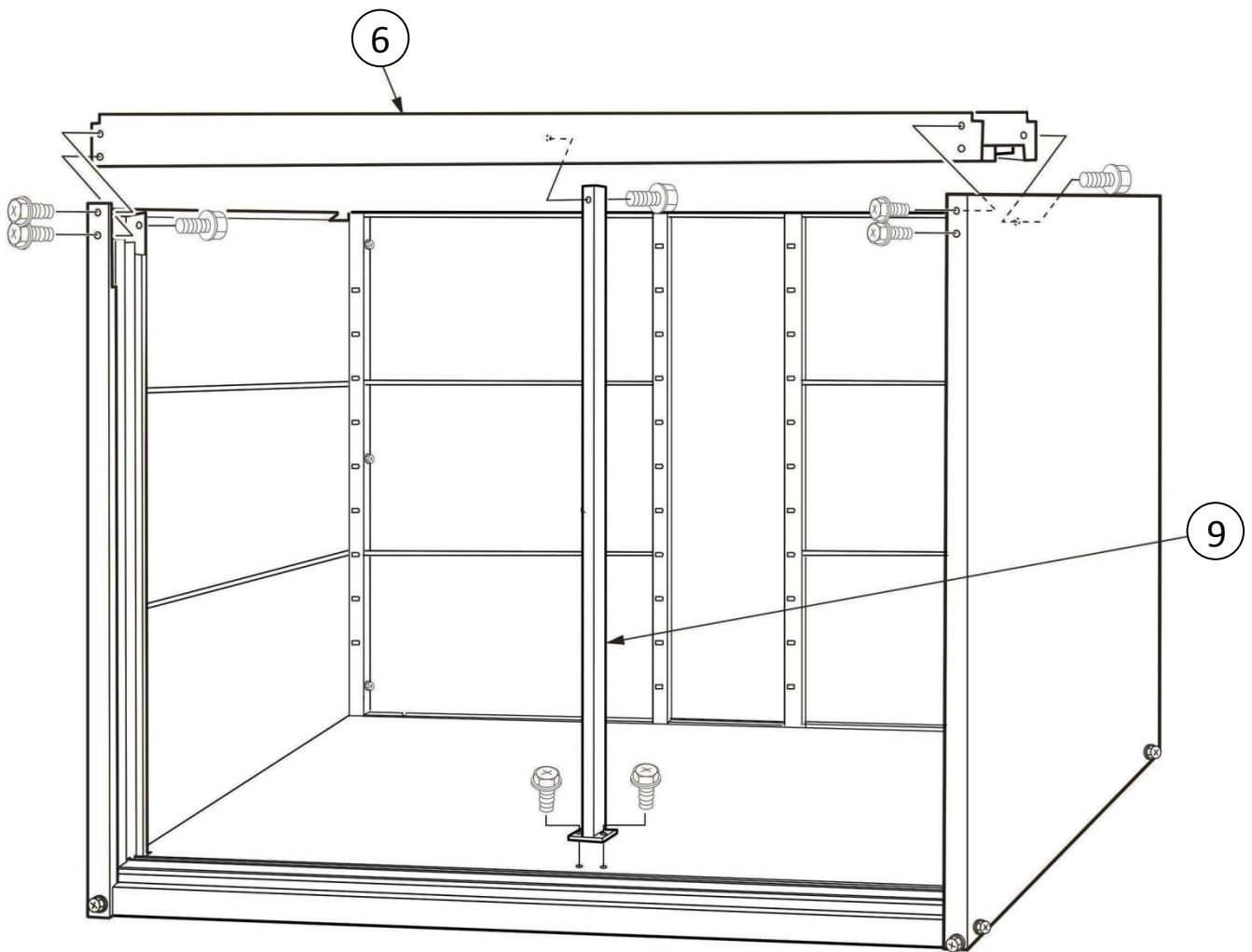

Figure 8.

<p>(GB)</p>	<p>Insert [Part 6] Beam into [Part 2] Side Panel (Left) and [Part 3] Side Panel (R). Secure using 6no. [Part 21] Hexagon Bolt. Fit [Part 9] Shelf Support and secure using 3no. [Part 21] Hexagon Bolt.</p>
<p>(F)</p>	
<p>(D)</p>	
<p>(NL)</p>	
<p>(I)</p>	
<p>(S)</p>	
<p>(DK)</p>	
<p>(N)</p>	

STEP 8 - Install Roof Panel

Figure 9.

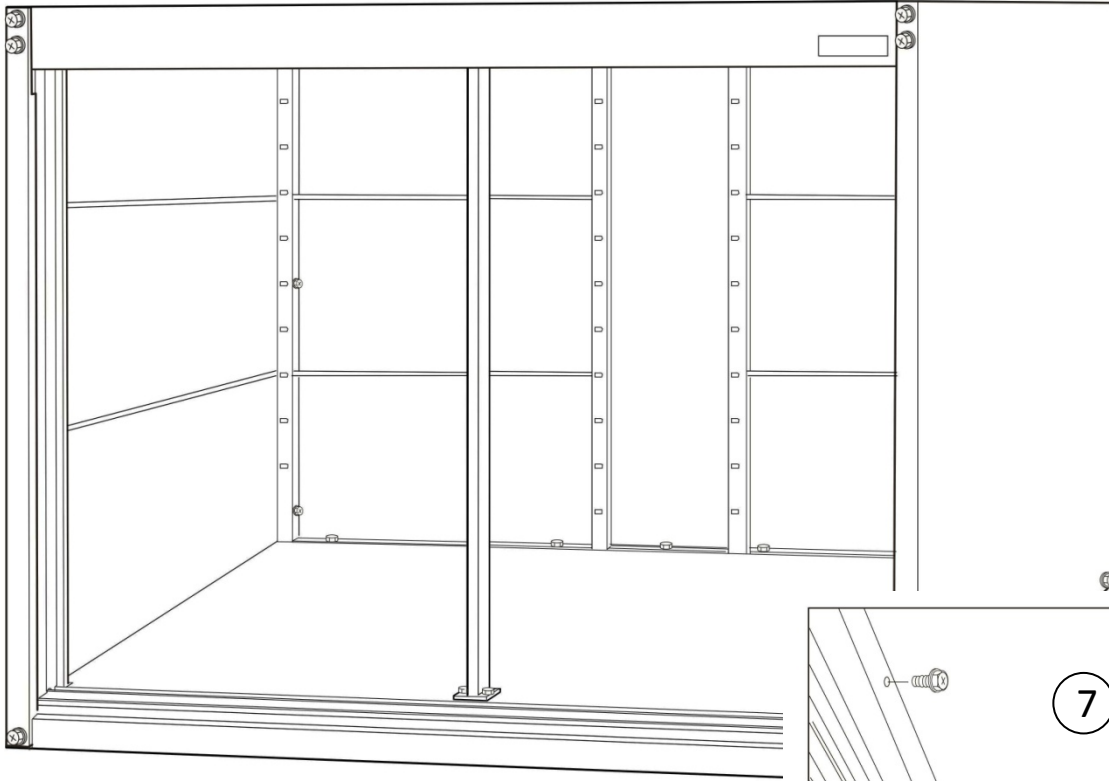
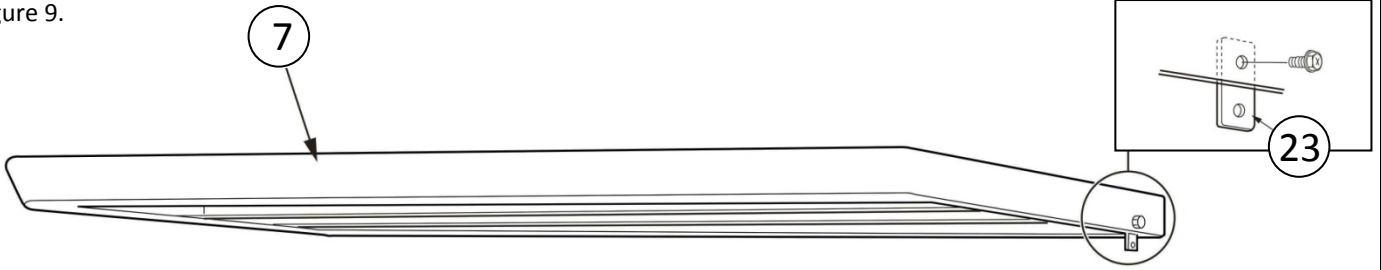
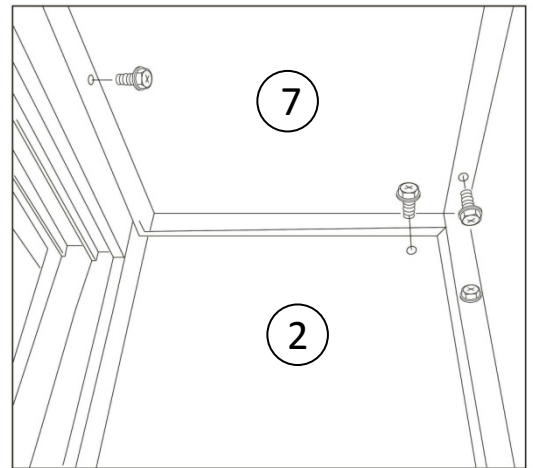

Figure 10.



(GB) Place the [Part 7] Roof Panel to overlap [Part 2] Side Panel (Left), [Part 3] Side Panel (Right), [Part 6] Beam, [Part 4] Back Panel (Large) and [Part 5] Back Panel (Small). Secure in place using 12no. [Part 21] Hexagon Bolt.

(F)

(D)

(NL)

(I)

(S)

(DK)

(N)

STEP 9 - Install Shelves

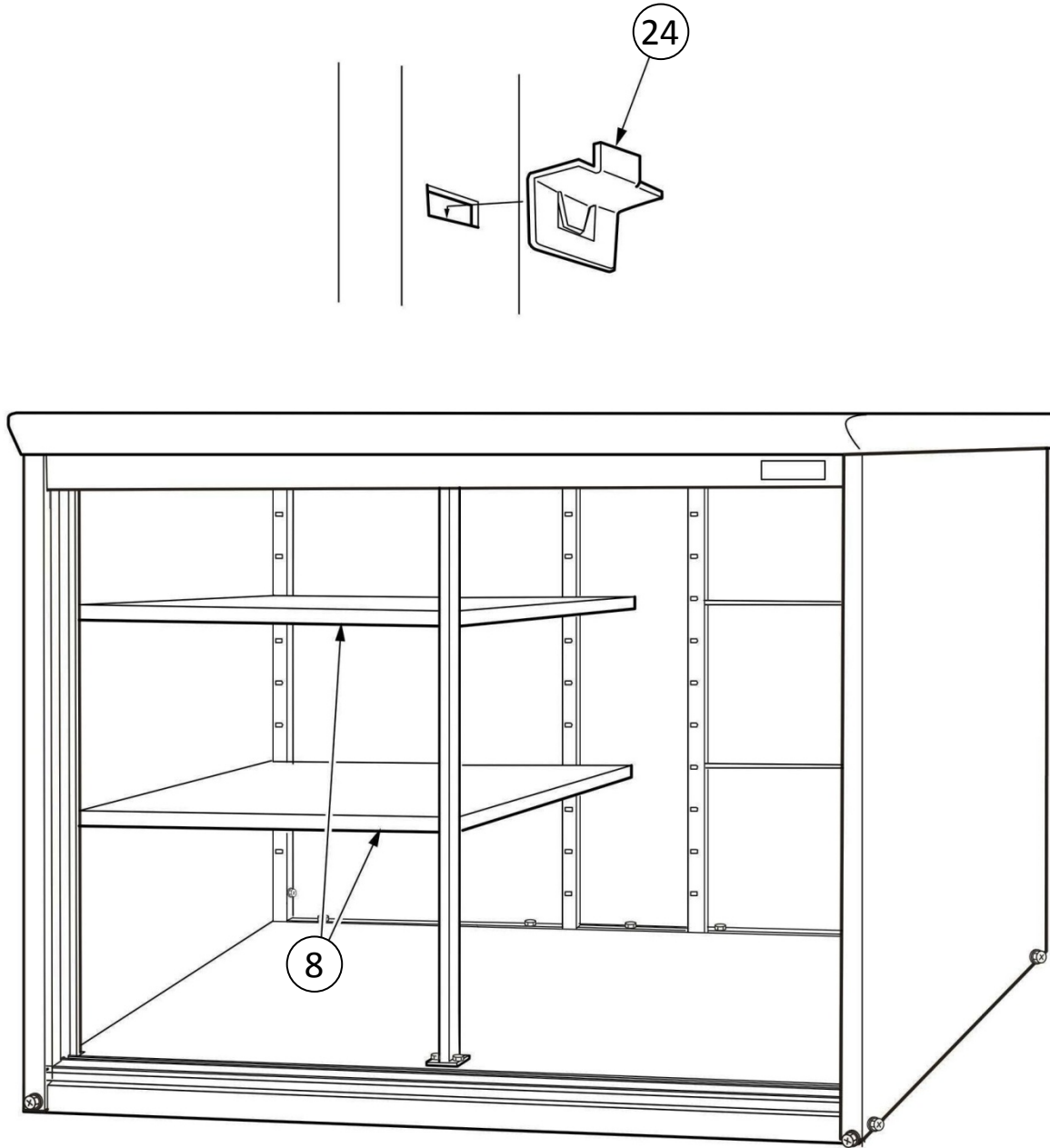

Figure 12.

(GB)

Insert [Part 24] Shelf Brackets at the desired height, 4 pieces per shelf.
Slot [Part 8] Shelf on top of [Part 24] Shelf Brackets.

(F)

(D)

(NL)

(I)

(S)

(DK)

(N)

STEP 10 - Install Lock Set and Door Guides

Figure 13.

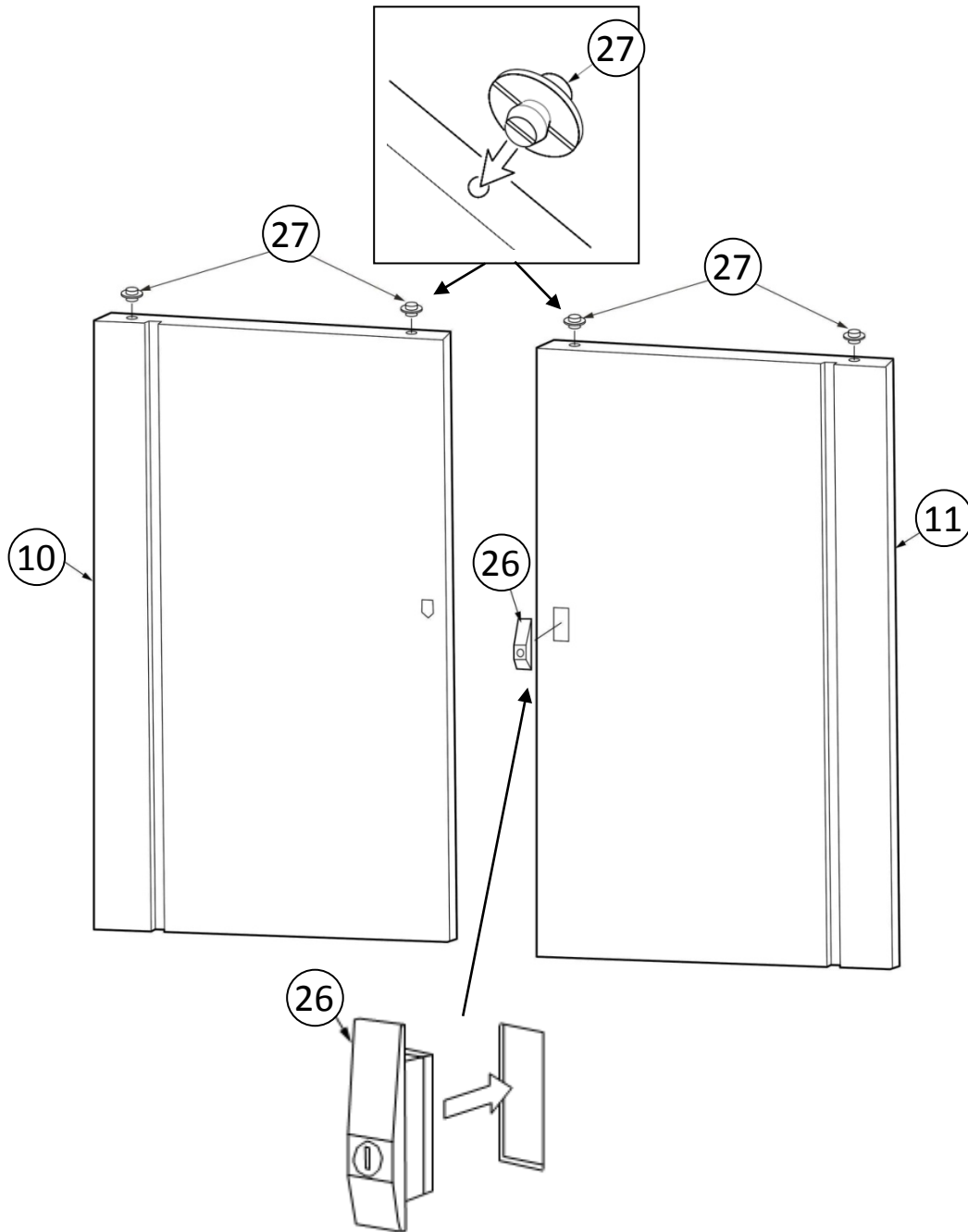

Figure 14.

(GB) Insert [Part 26] Lock Set in [Part 11] Sliding Door. Take care to install [Part 26] Lock Set as pictured
 Insert 2no. [Part 27] Door Guide into top of [Part 10] Sliding Door (Left) and [Part 11] Sliding Door (Right).

(F)

(D)

(NL)

(I)

(S)

(DK)

(N)

STEP 11 - Install Sliding Doors

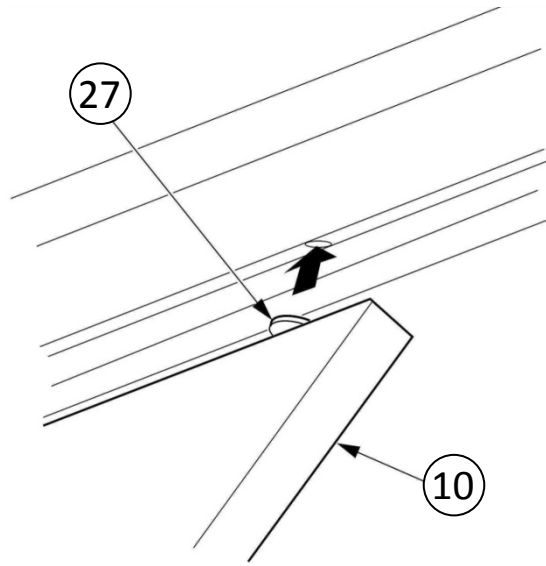

Figure 15.

(GB)

To install [Part 10] Sliding Door (Left) push the Door Guides into the holes located on the underside of [Part 6] Beam on the **rear** slide rail. This will give the clearance required to install the runners on the bottom of the door onto the slide panel on the Floor Panel.

Repeat to install [Part 11] Sliding Door (Right) but use the **front** slide rail on [Part 6] Beam.

(F)

(D)

(NL)

(I)

(S)

(DK)

(N)

STEP 12 - Install Bolt Covers

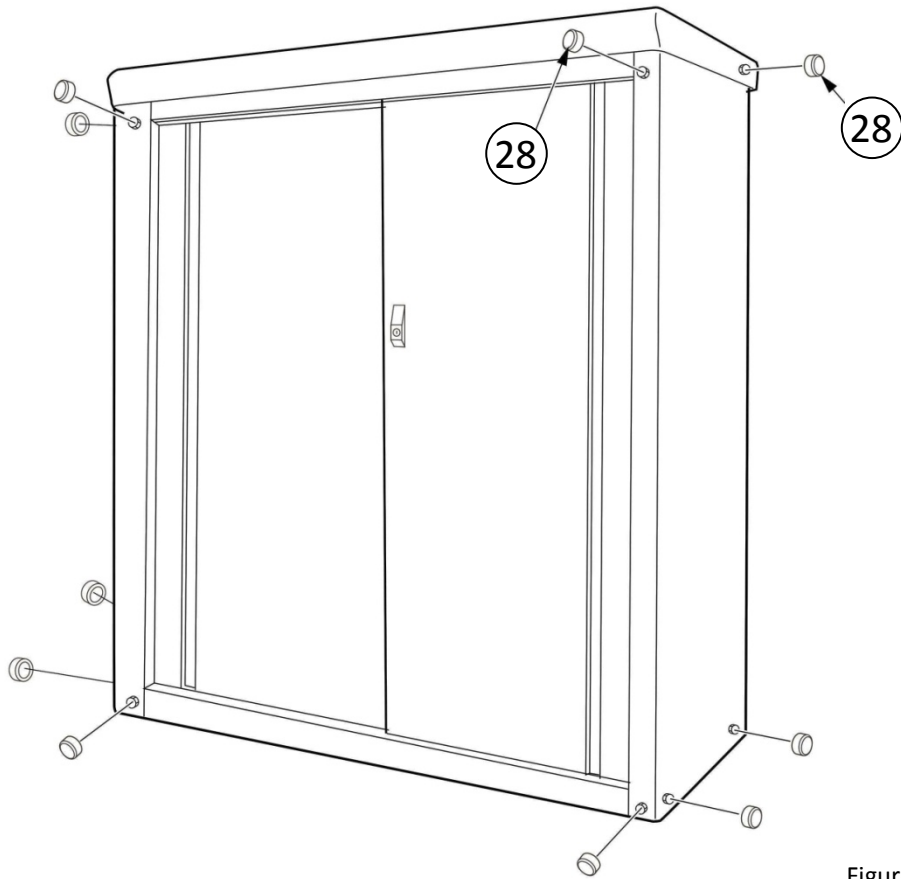

Figure 16.

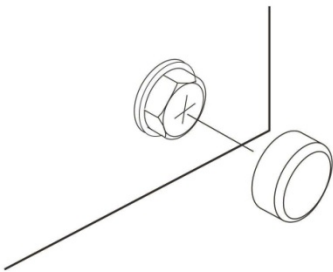

Figure 17.

(GB)

Ensure all bolts are fully tightened.
Push [Part 28] Bolt Covers on head of all external bolts. 12 in total.

(F)

(D)

(NL)

(I)

(S)

(DK)

(N)

STEP 13 - Install Wall Anchor (optional)

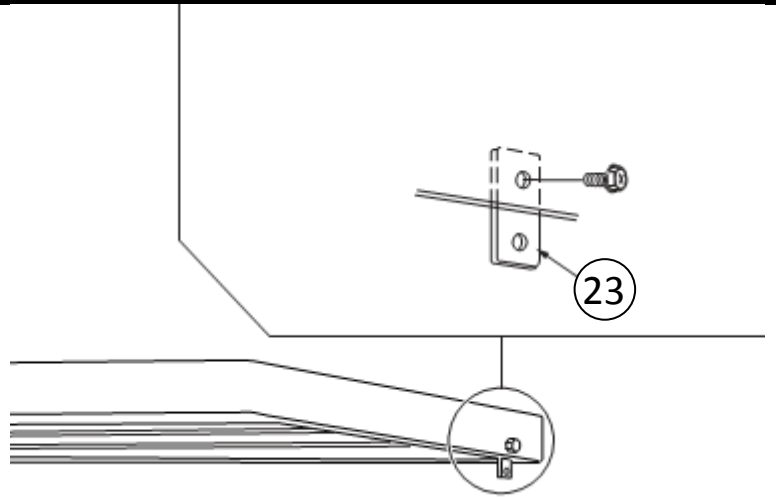

Figure 18.

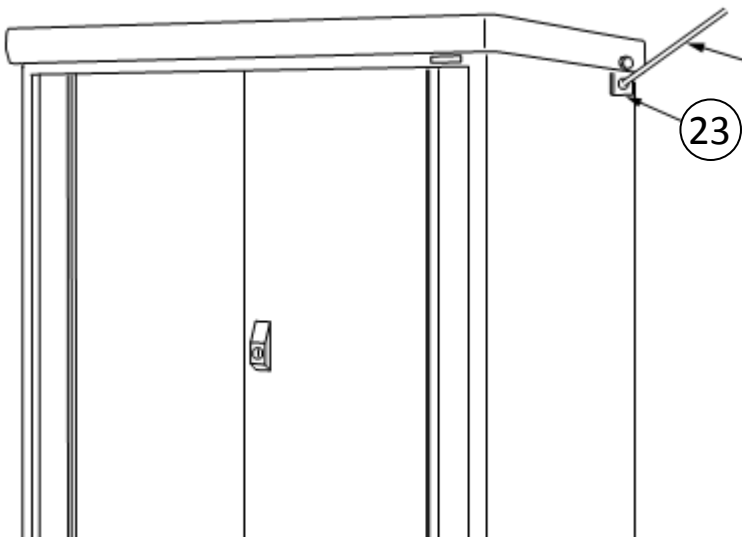

Figure 19.

(GB)

Insert [Part 23] Wall Anchor Bracket between Side Panel and Roof Panel and secure in place using [Part 21] Hexagon Bolt. Two Wall Anchor Brackets are required, one of each side of the Guardian Shed.
Use a heavy duty cable when fixing to a wall.

(F)

(D)

(NL)

(I)

(S)

(DK)

(N)

STEP 14 - Install L Shaped Anchor Plate (optional)

Figure 20.

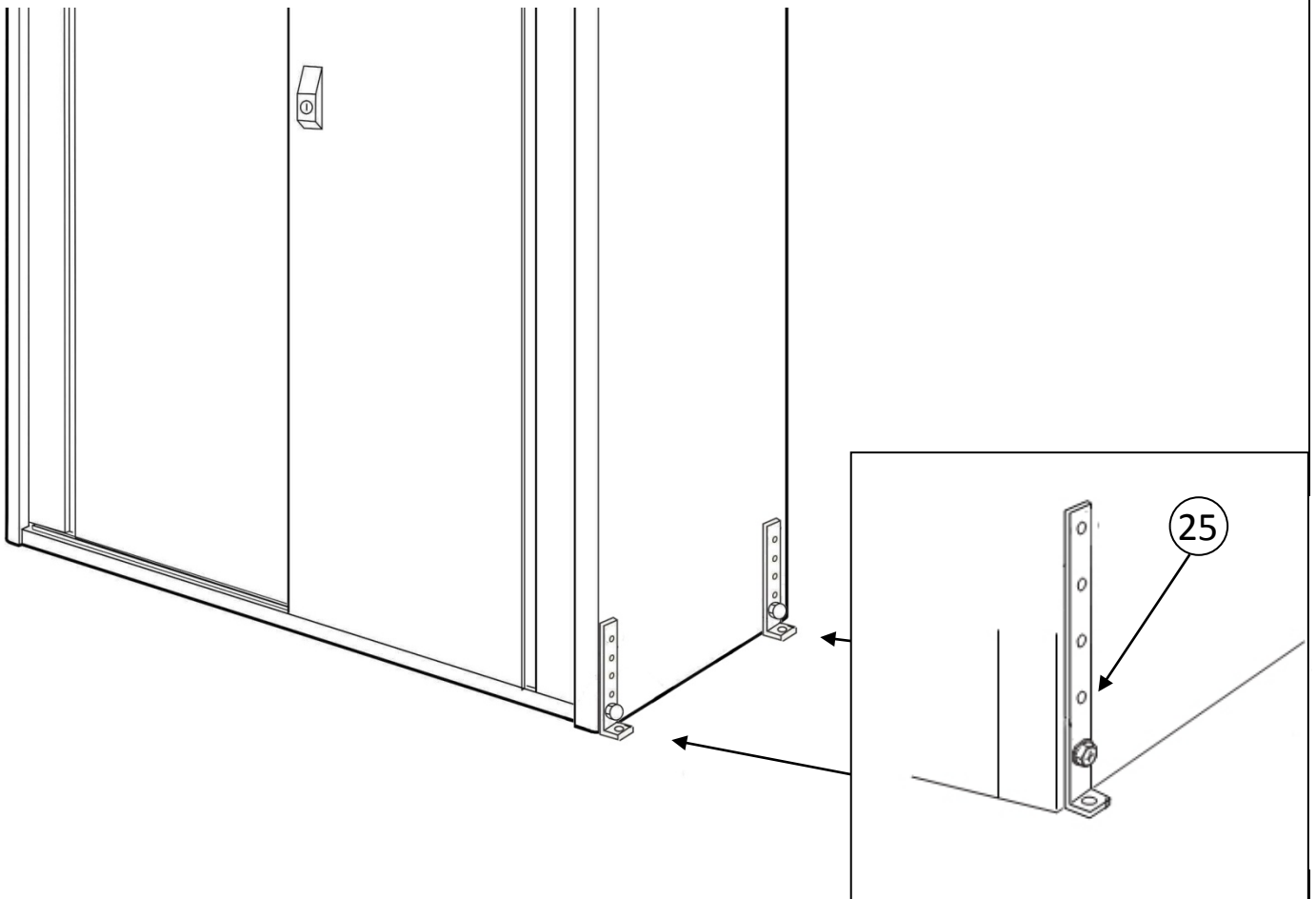

Figure 21.

<p>(GB)</p>	<p>Fit [Part 25] L Shaped Anchor Plate to the shed using the lowest hole setting. Using an anchor bolt (not provided) secure to a hard base. Alternatively, use a higher hole setting to sink the bracket into the ground.</p>
<p>(F)</p>	
<p>(D)</p>	
<p>(NL)</p>	
<p>(I)</p>	
<p>(S)</p>	
<p>(DK)</p>	
<p>(N)</p>	

STEP 15 - Final Check

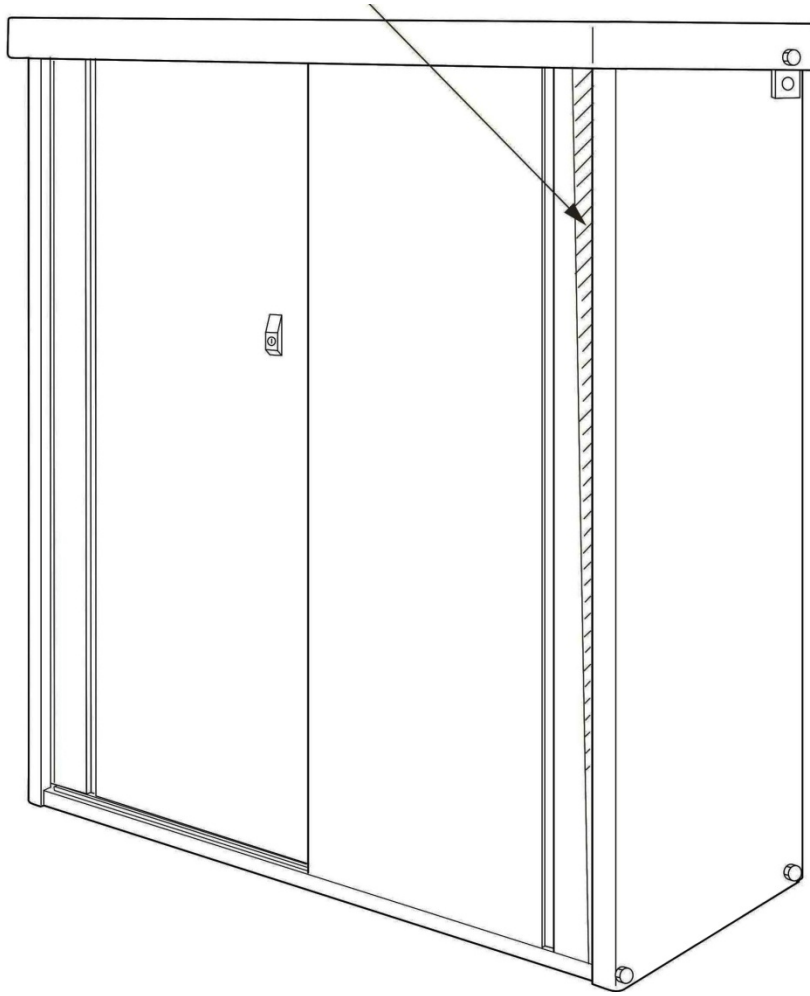

Figure 22.

(GB)

If there is a gap between the sliding door and the side panel, please check if the shed is square by measuring the diagonals, both measurements should be equal.
Ensure the shed is installed on a flat and level ground.

(F)

(D)

(NL)

(I)

(S)

(DK)

(N)

