

SOJAG

QUESTIONS? +49 (0) 6571 / 95117-0

Assembly Manual / Guide d'assemblage / Manual de ensamblaje / 조립설명서 / Montageanleitung

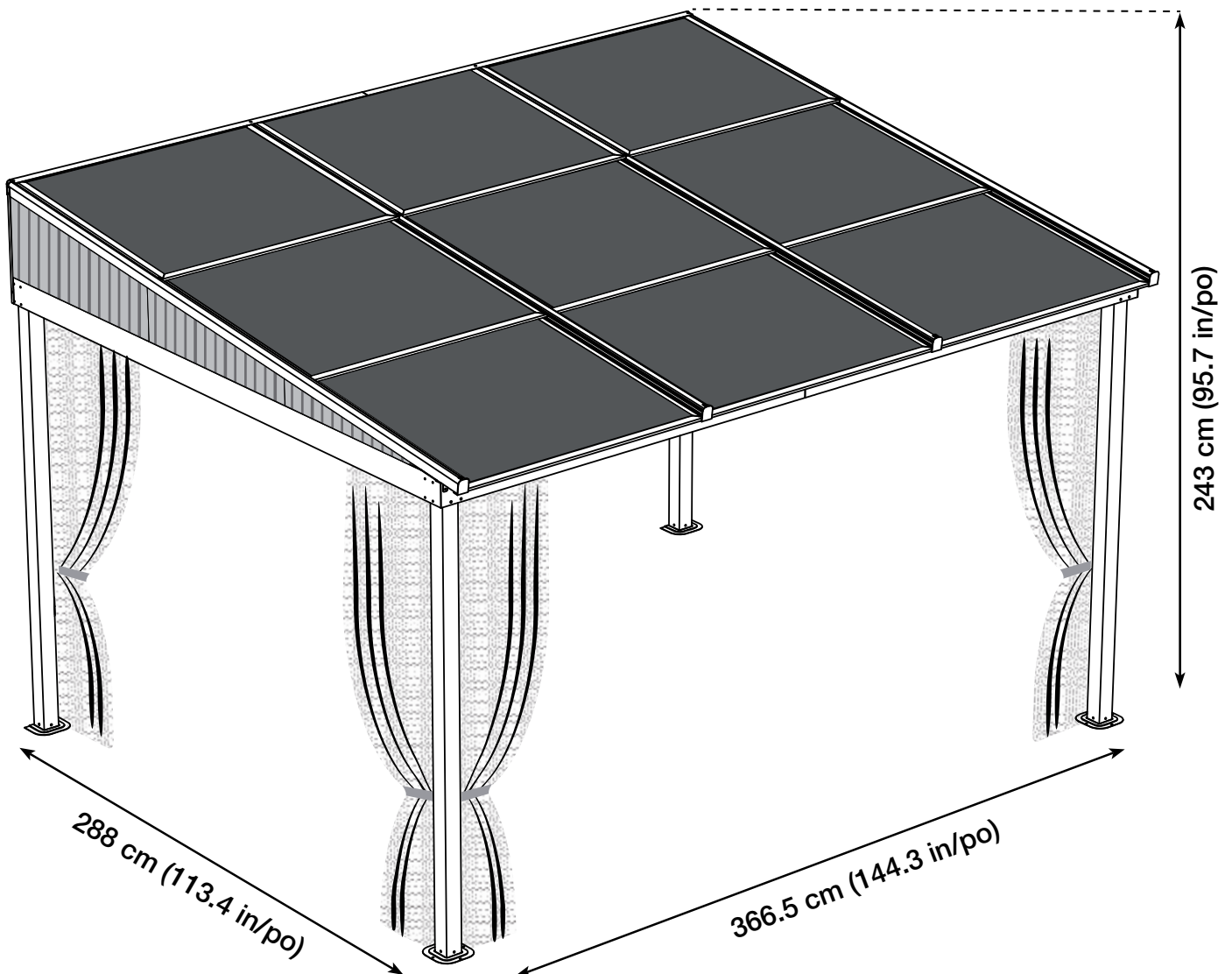

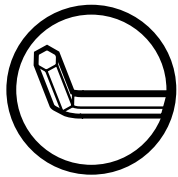

Use the hex keys in the box. / Utilisez les clés hexagonales fournies dans la boîte. / Utilice las llaves hexagonales en la caja. / 상자에 육각 키를 사용 하십시오. / Verwenden Sie die Sechskantschlüssel in der Box.

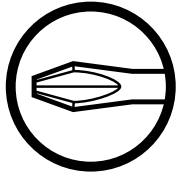

Please use a Phillips screwdriver. / Utilisez un tournevis de type Phillips / Por favor, use un destornillador Phillips. / 십자 드라이버를 사용 하십시오. / Bitte verwenden Sie einen Kreuzschraubenzieher.



You may need to use a drill for this step. / Vous pouvez avoir besoin d'utiliser une perceuse pour cette étape. / Puede que tenga que utilizar un taladro para este paso. / 이 단계에선 드릴을 사용해야 할 수도 있습니다. / Für diesen Schritt können Sie einen Bohrer verwenden.



Wearing protective gloves is recommended. / Le port de gants de protection est recommandé / El uso de guantes de protección se recomienda. / 보호 장갑을 착용 하는 것이 좋습니다. / Das Tragen von Schutzhandschuhen wird empfohlen.



Two or more people are required at this stage. / Deux personnes ou plus sont nécessaires à cette étape. / Dos o más personas se requieren en esta etapa. / 이 단계에서는 두 명 이상 이 필요합니다. / Für diesen Bauschritt sind 2 oder mehr Personen erforderlich.



Do not tighten screws all the way for now. / Ne pas visser fermement pour l'instant. / No atornille con firmeza por ahora. / 아직 나사를 단단히 조이지 마십시오. / Bitte die Schrauben zum jetzigen Zeitpunkt noch nicht fest anziehen.

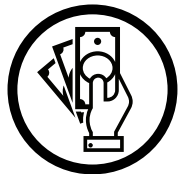

Sold separately. / Vendus séparément. / vendido en las opciones. / 옵션 판매 / Optional erhältlich

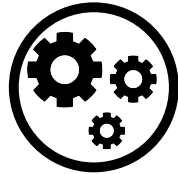

Optional step / Étape optionnelle / Paso opcional / 선택적 단계 / Optionaler Schritt

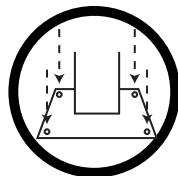

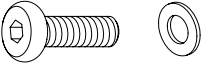
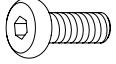

The gazebo must be anchored (hardware not included) / Le gazébo doit être ancré (quincaillerie non incluse) / El gazebo debe estar anclado (herramientas no incluidas) / gaze보를 반드시 바닥에 고정 시키세요. (고정 나사 부품 미포함) / Muss am Boden verankert werden, Befestigungsmaterial nicht im Lieferumfang enthalten

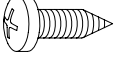
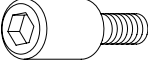
U X4 (+2) 	W X108 (+10) 
--	---

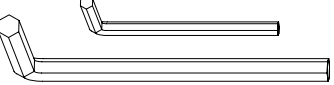
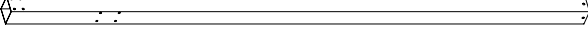
W1 X4 (+2) 	X X32 (+3) 
---	---

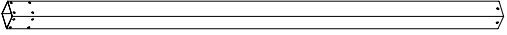
Z X1 	A X1 
---	--

A1 X1 	B X2 
--	--

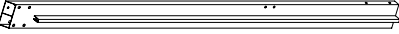
C X1 	C1 X1 
---	---

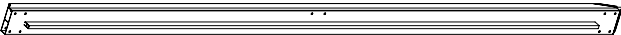
D X1 	D1 X1 
---	---

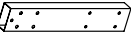
E X2 	E1 X1 
---	--

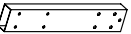
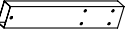
E2 X1 	E3 X1 
--	--

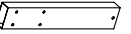
E4 X1 
--

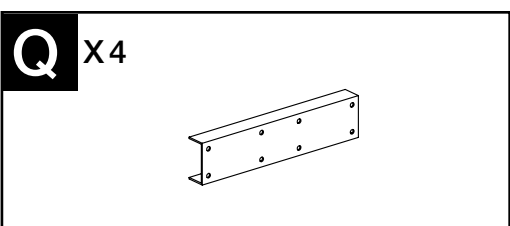
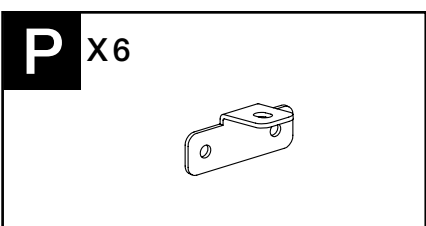
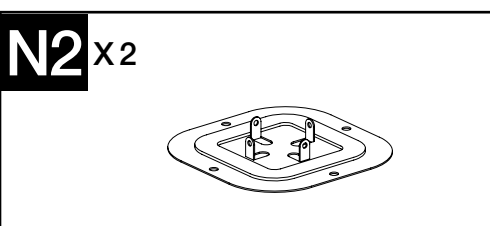
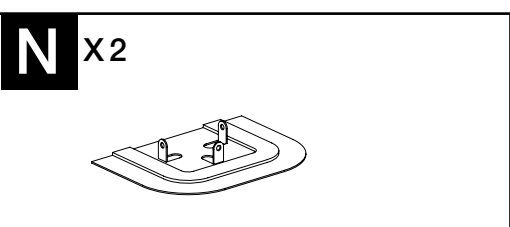
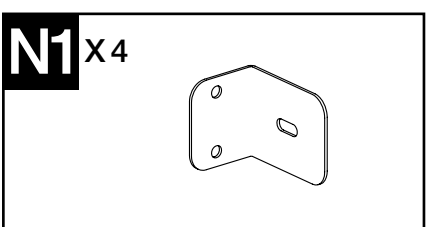
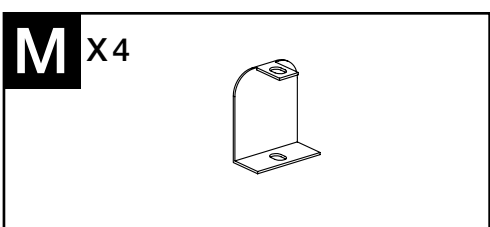
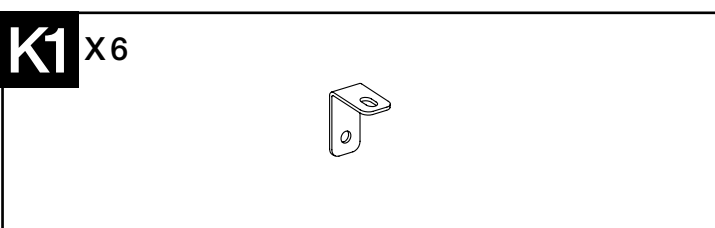
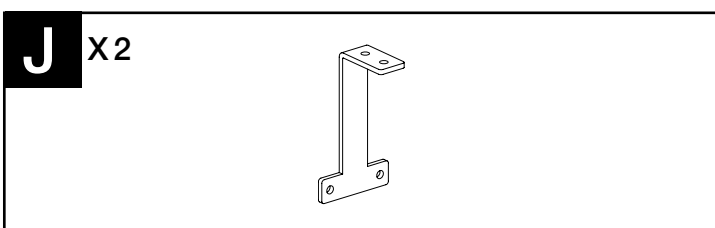
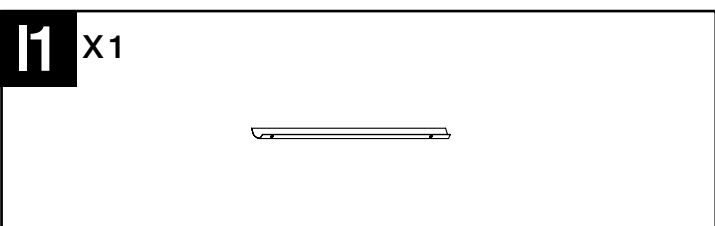
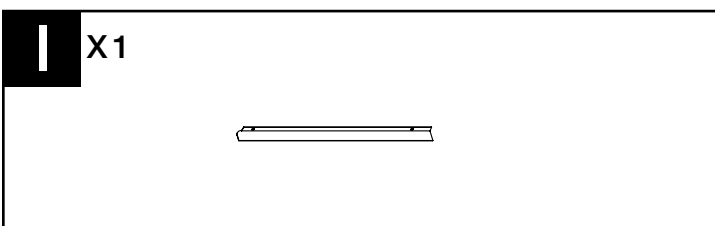
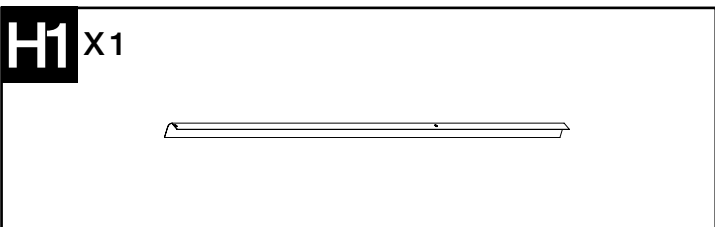
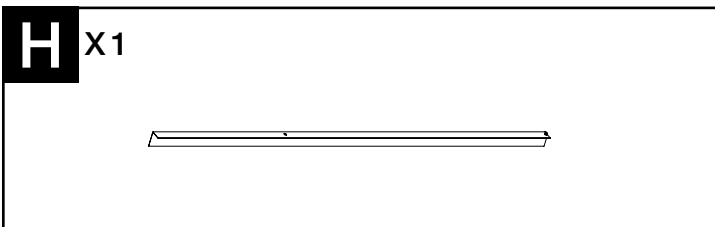
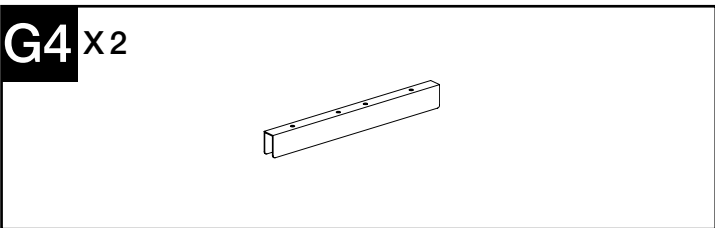
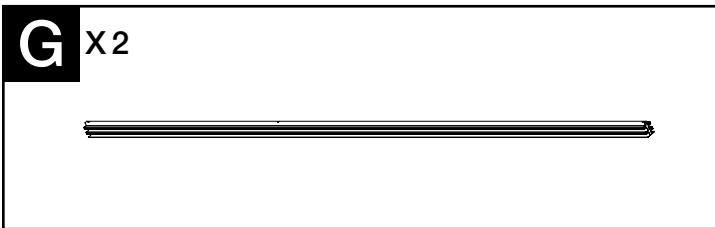
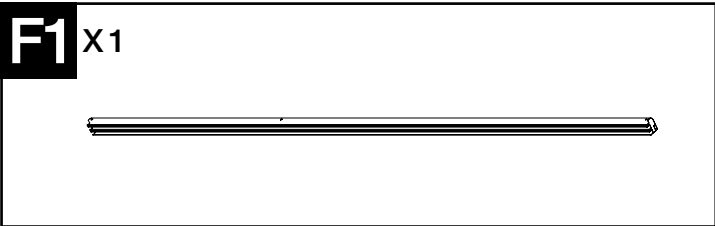
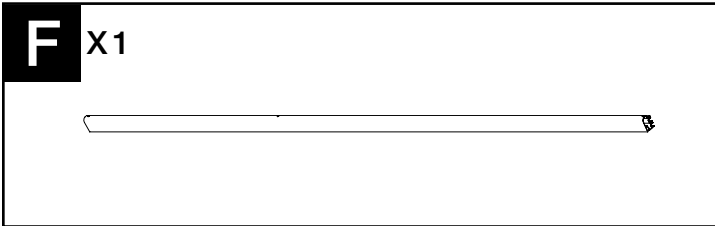

K1ax1

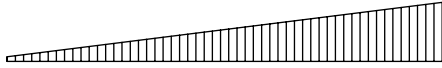

K1bx1

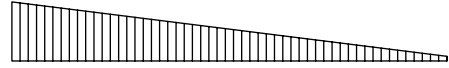

K2ax1

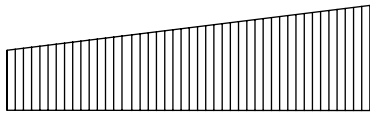

K2bx1

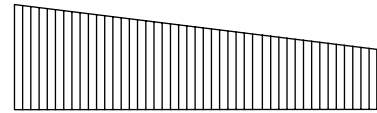

K3ax1

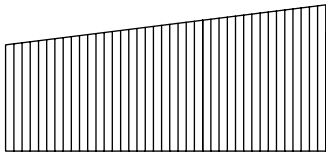

K3bx1

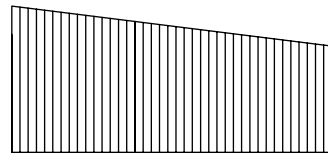

R3ax3

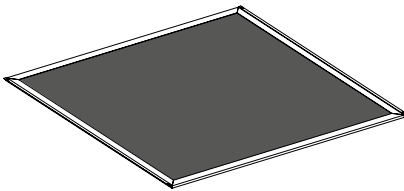

R3bx3

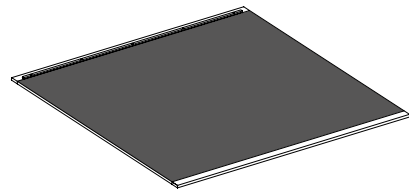

R3cx3

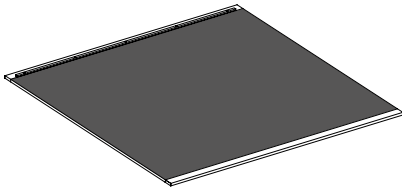

RR X 38(+2)



RR X 38(+2)



optional



Net

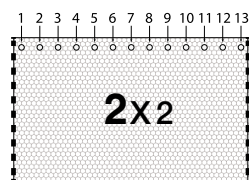
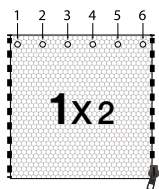

Curtain

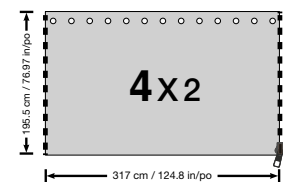
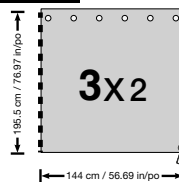

optional



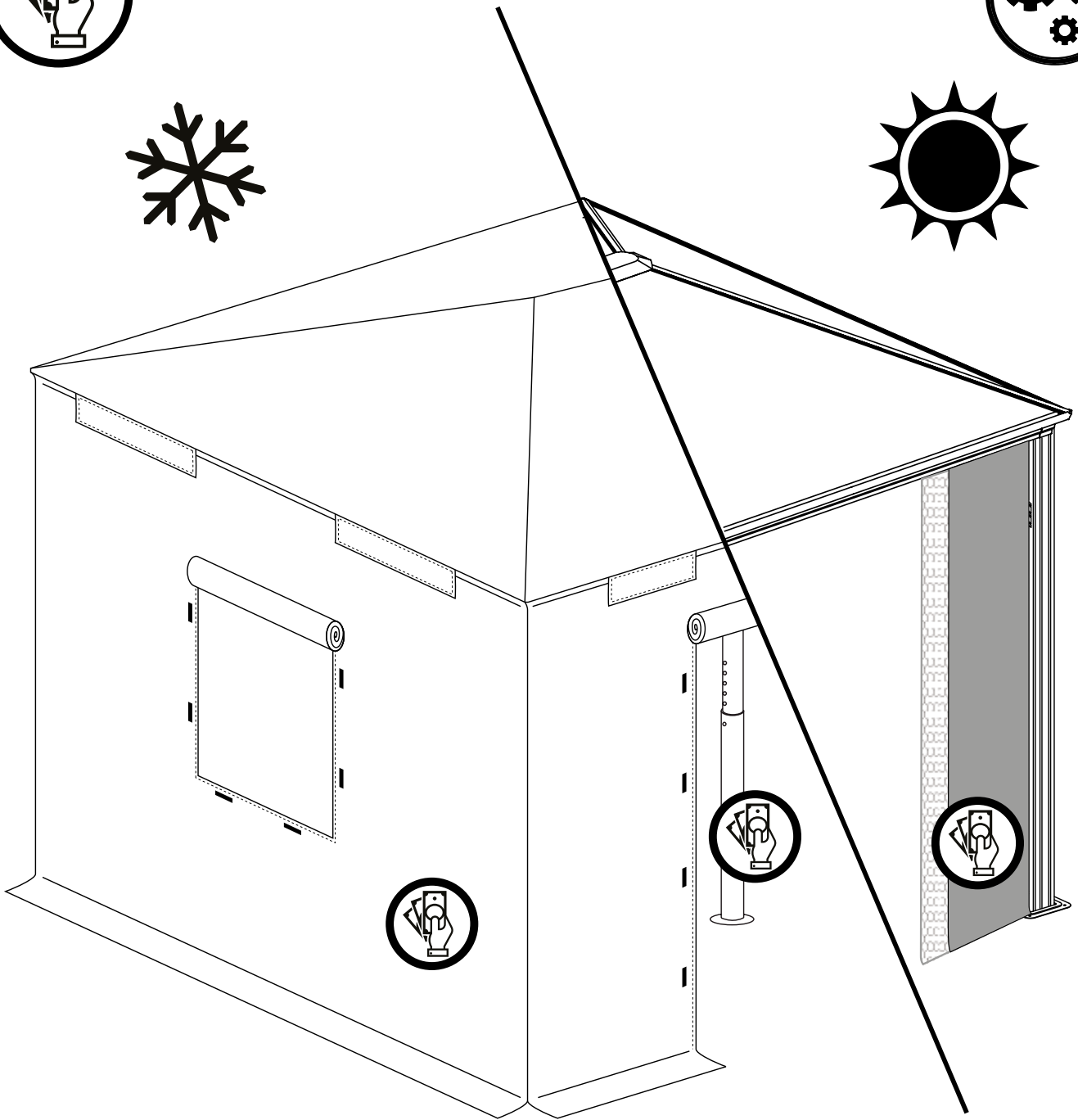
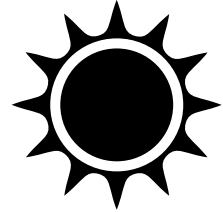
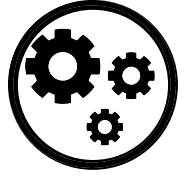
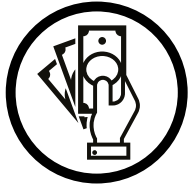

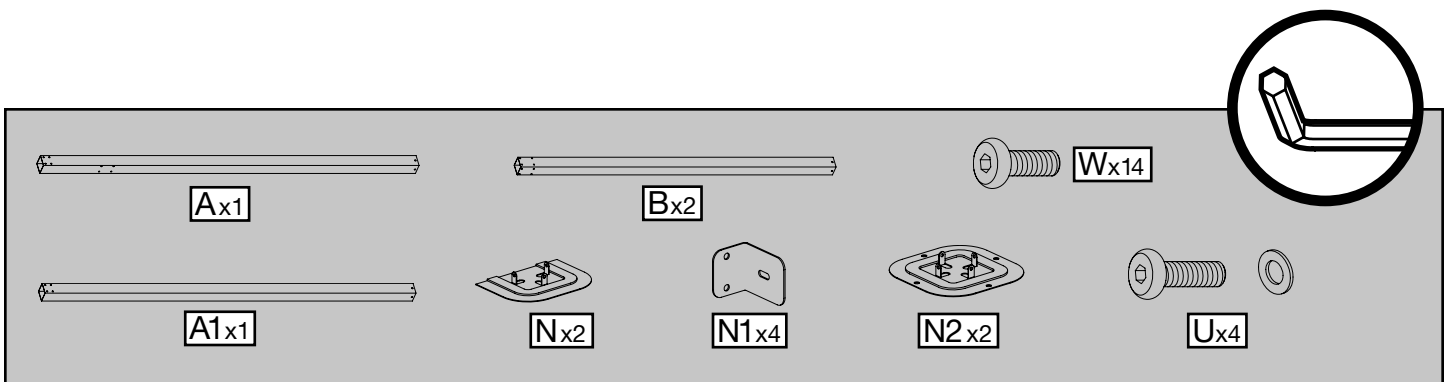
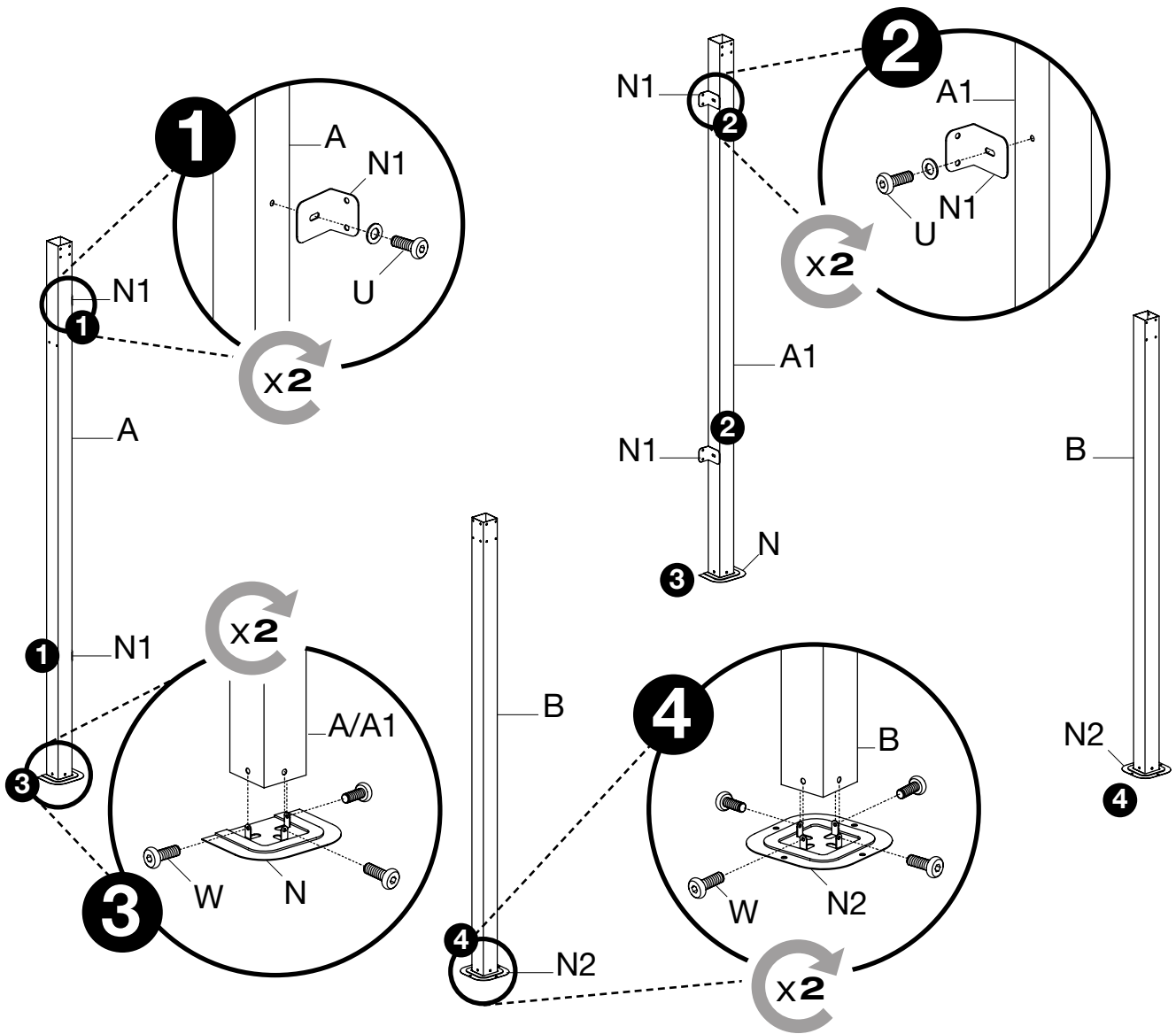

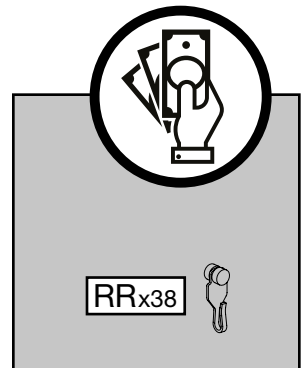
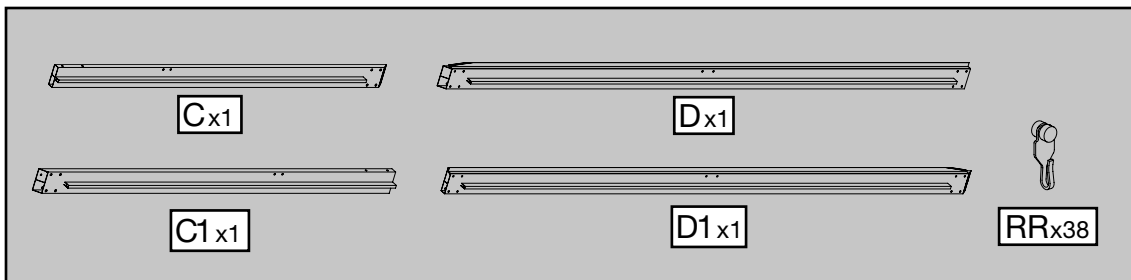
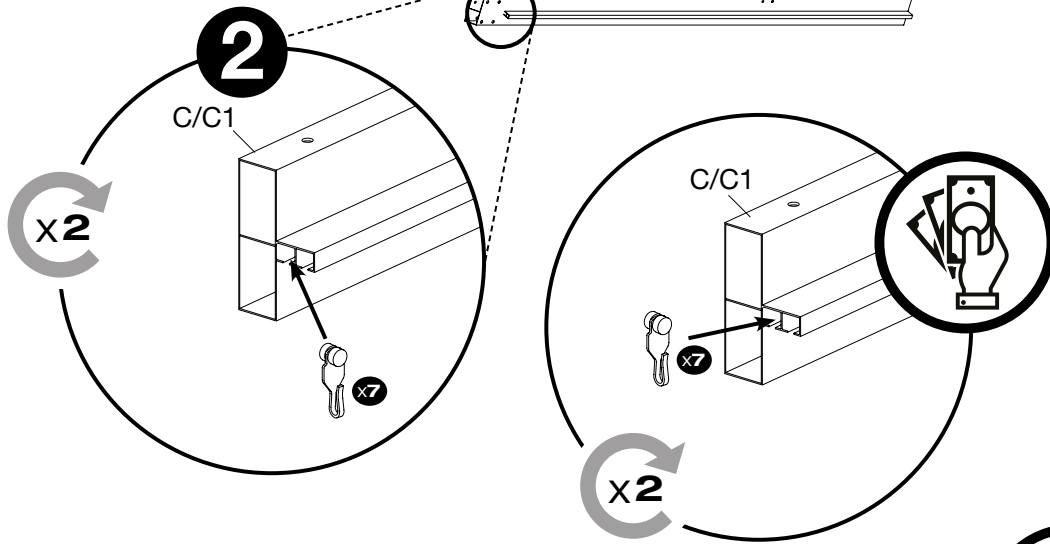
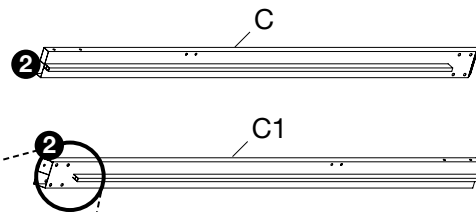
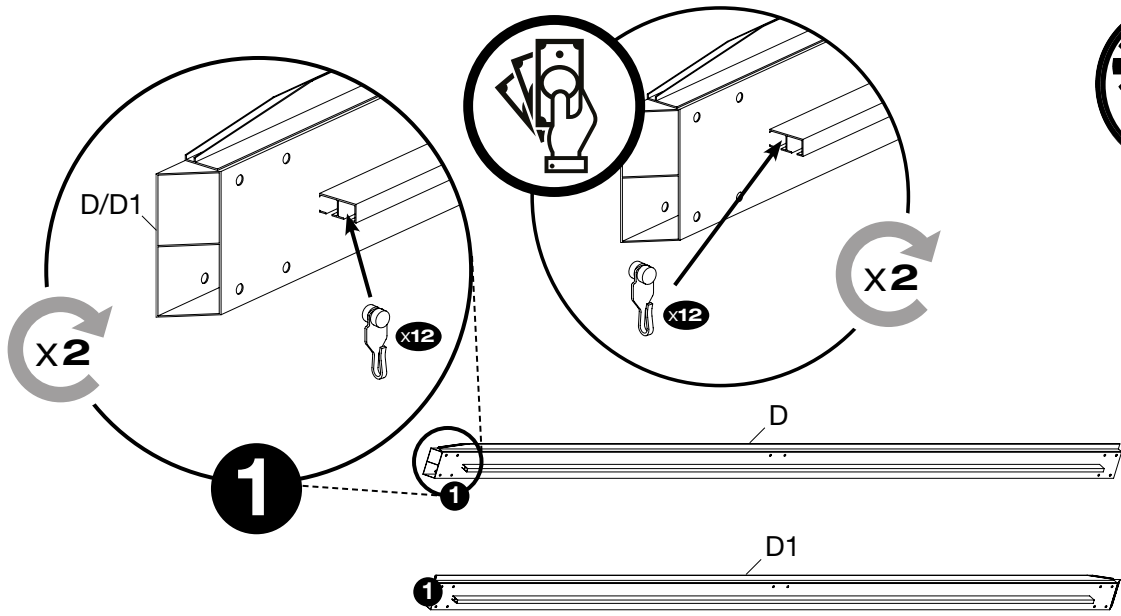
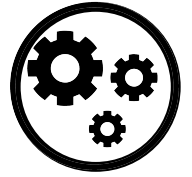

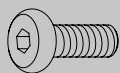
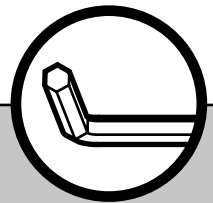
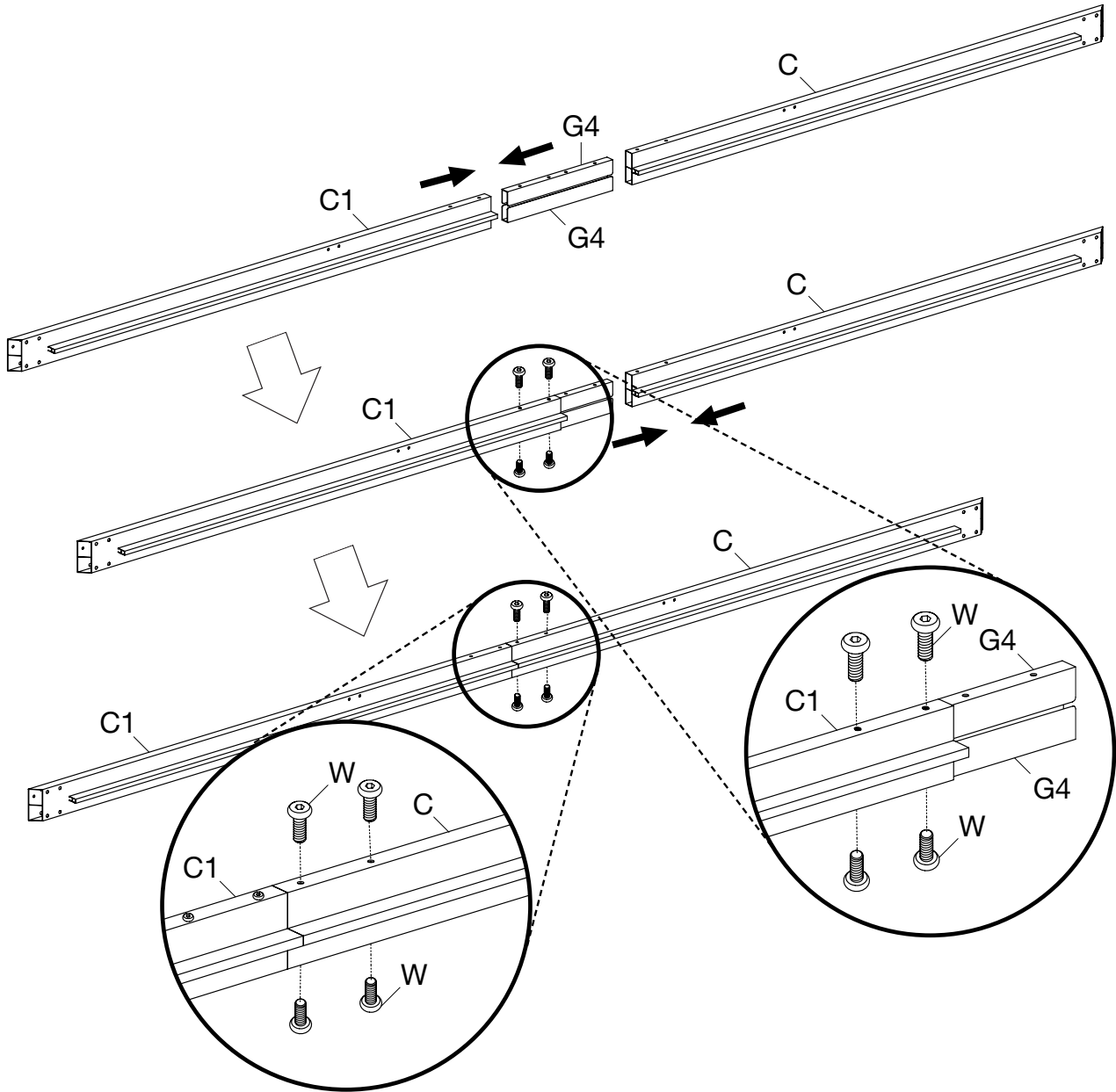

Wx8

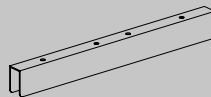

G4x2

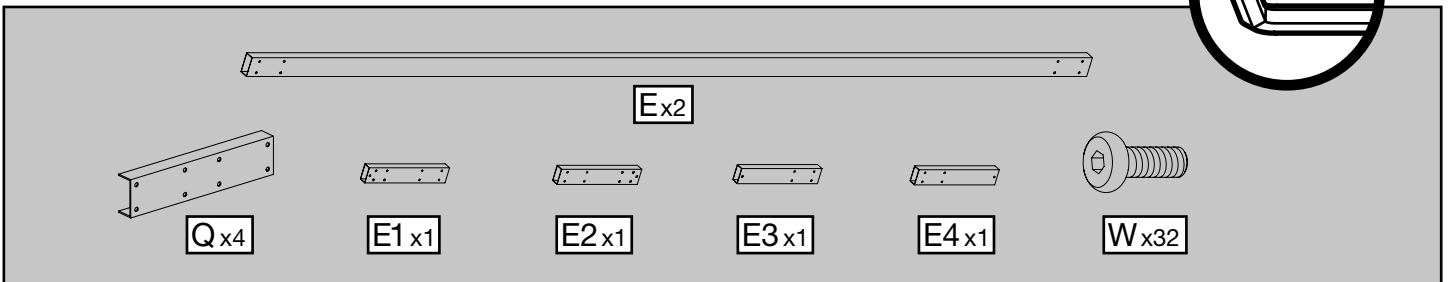
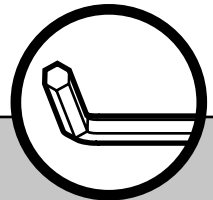
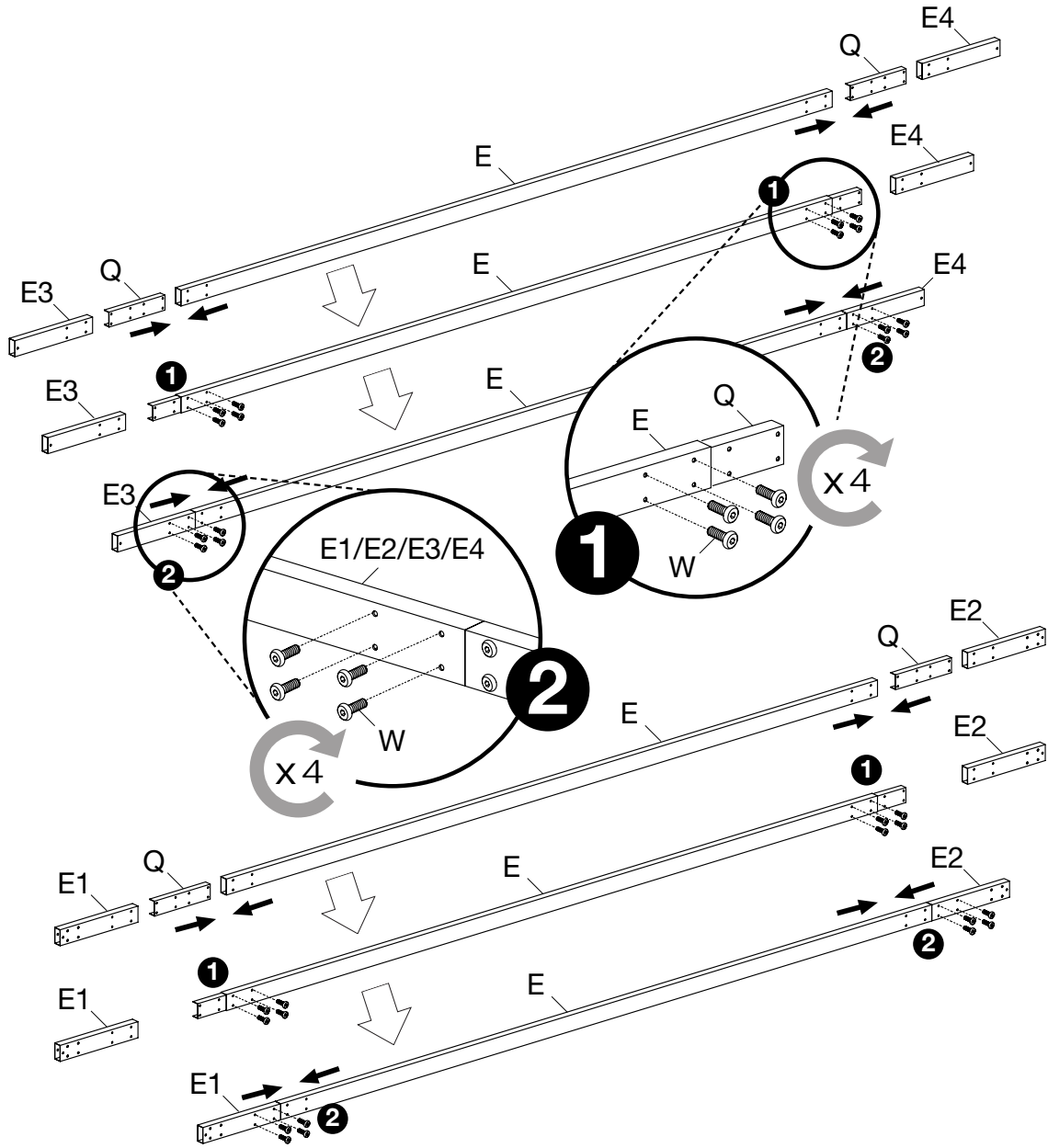

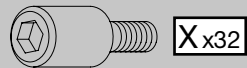
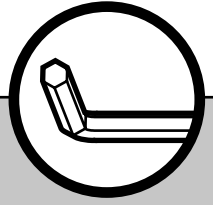
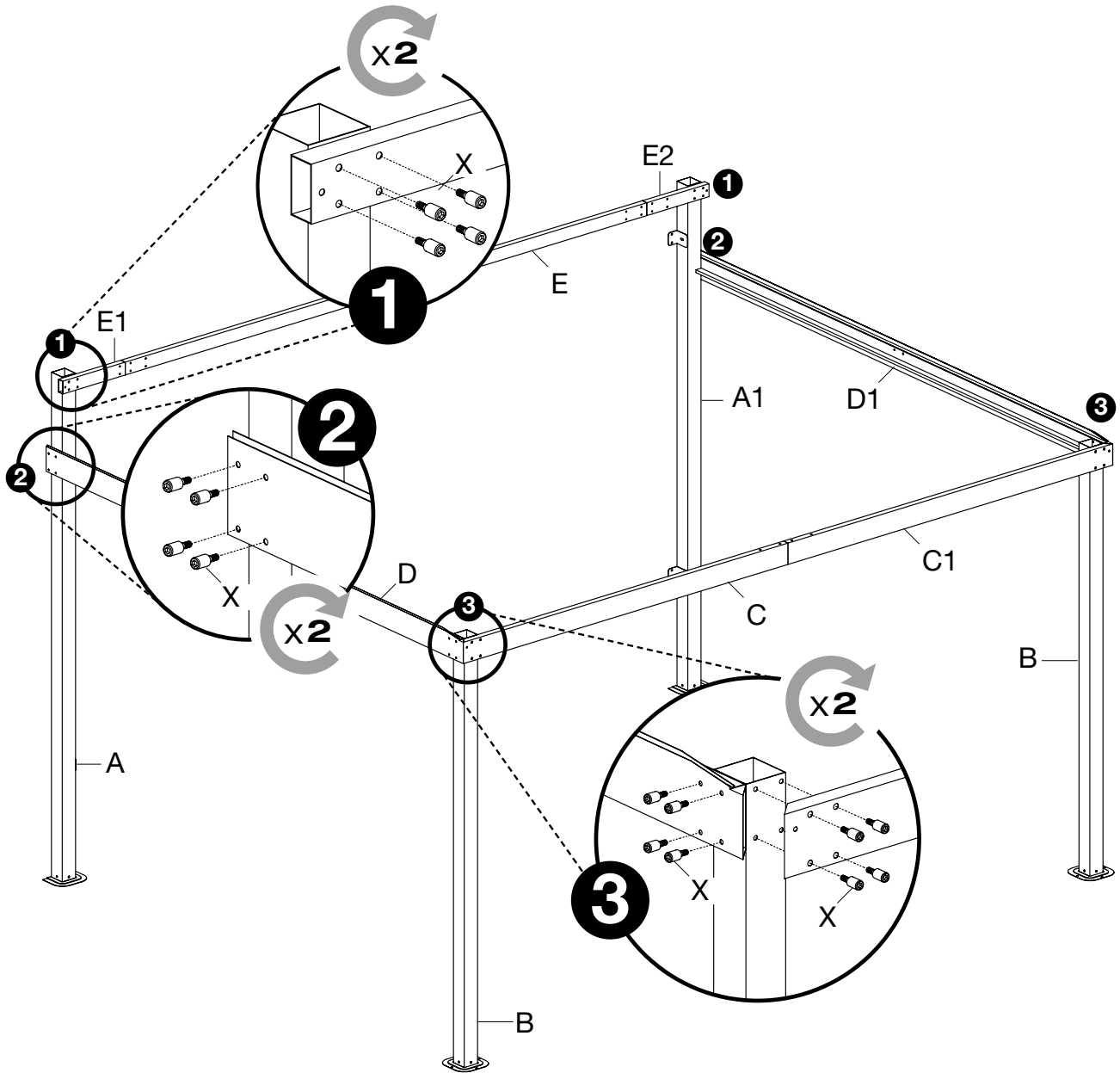

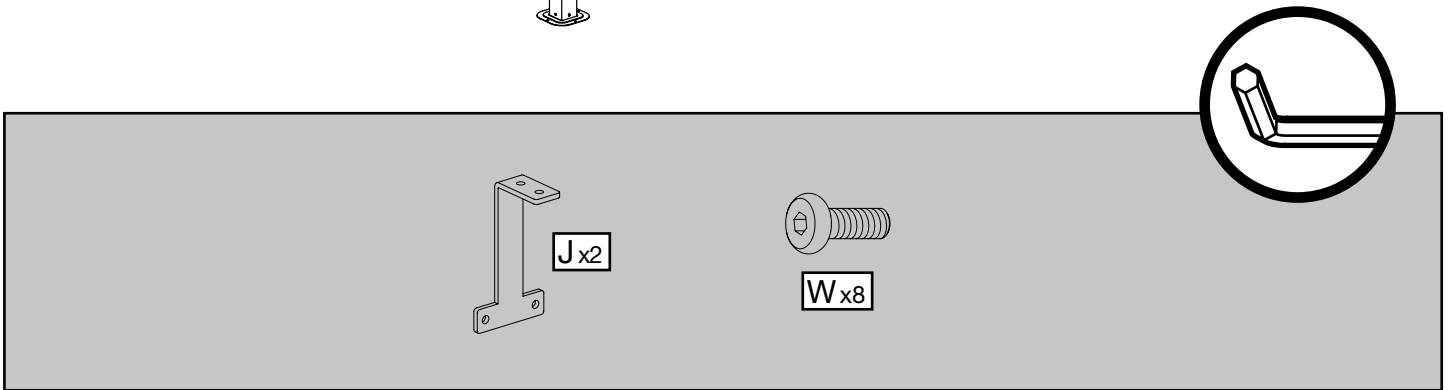
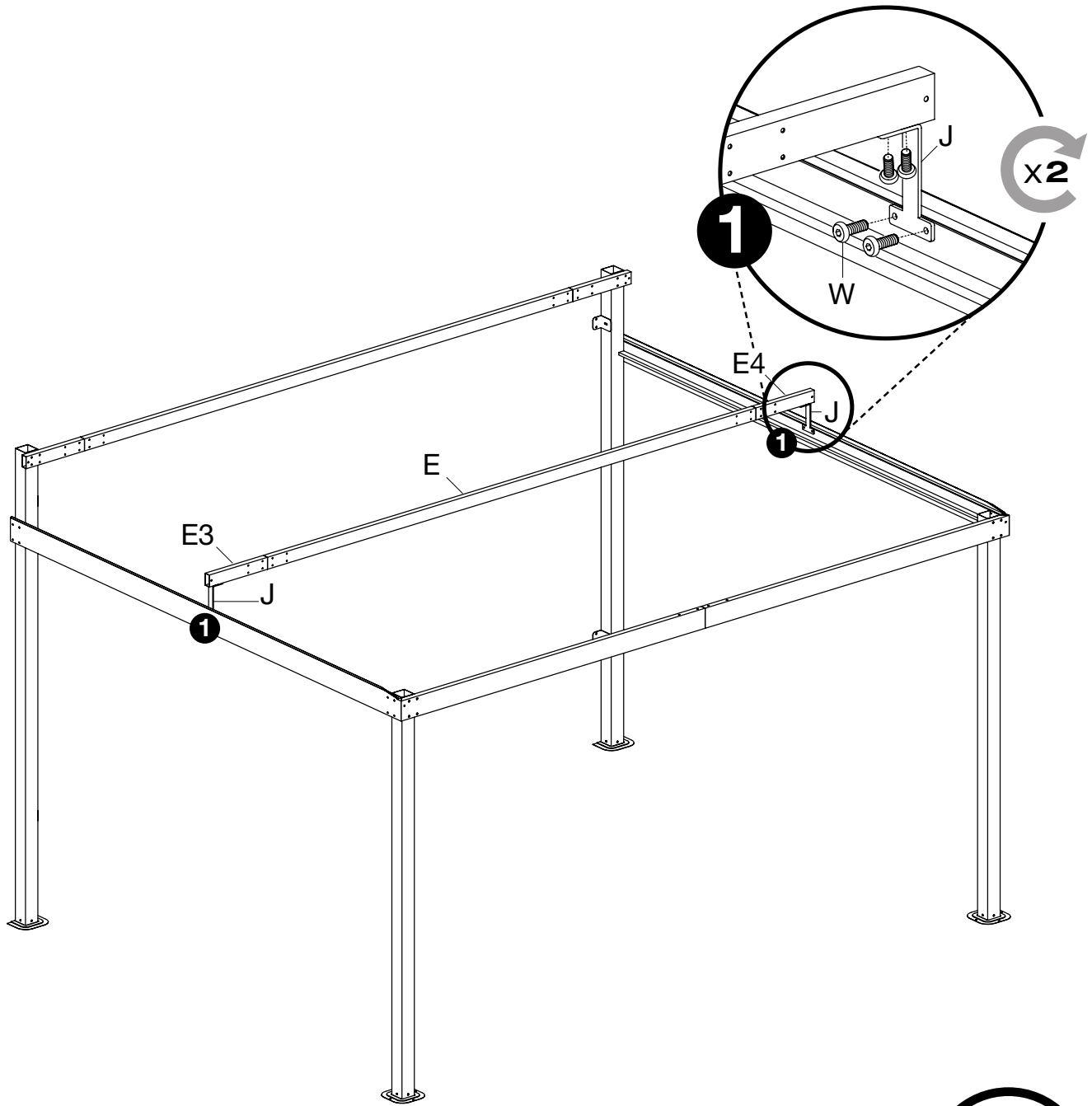

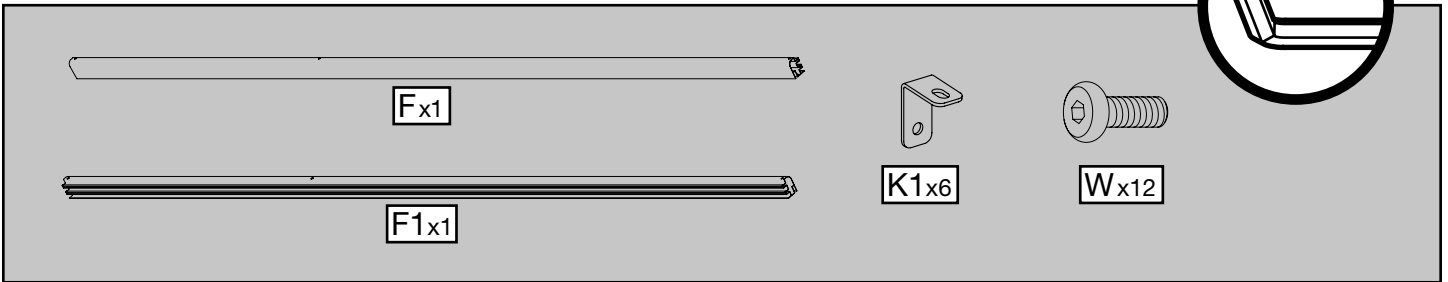
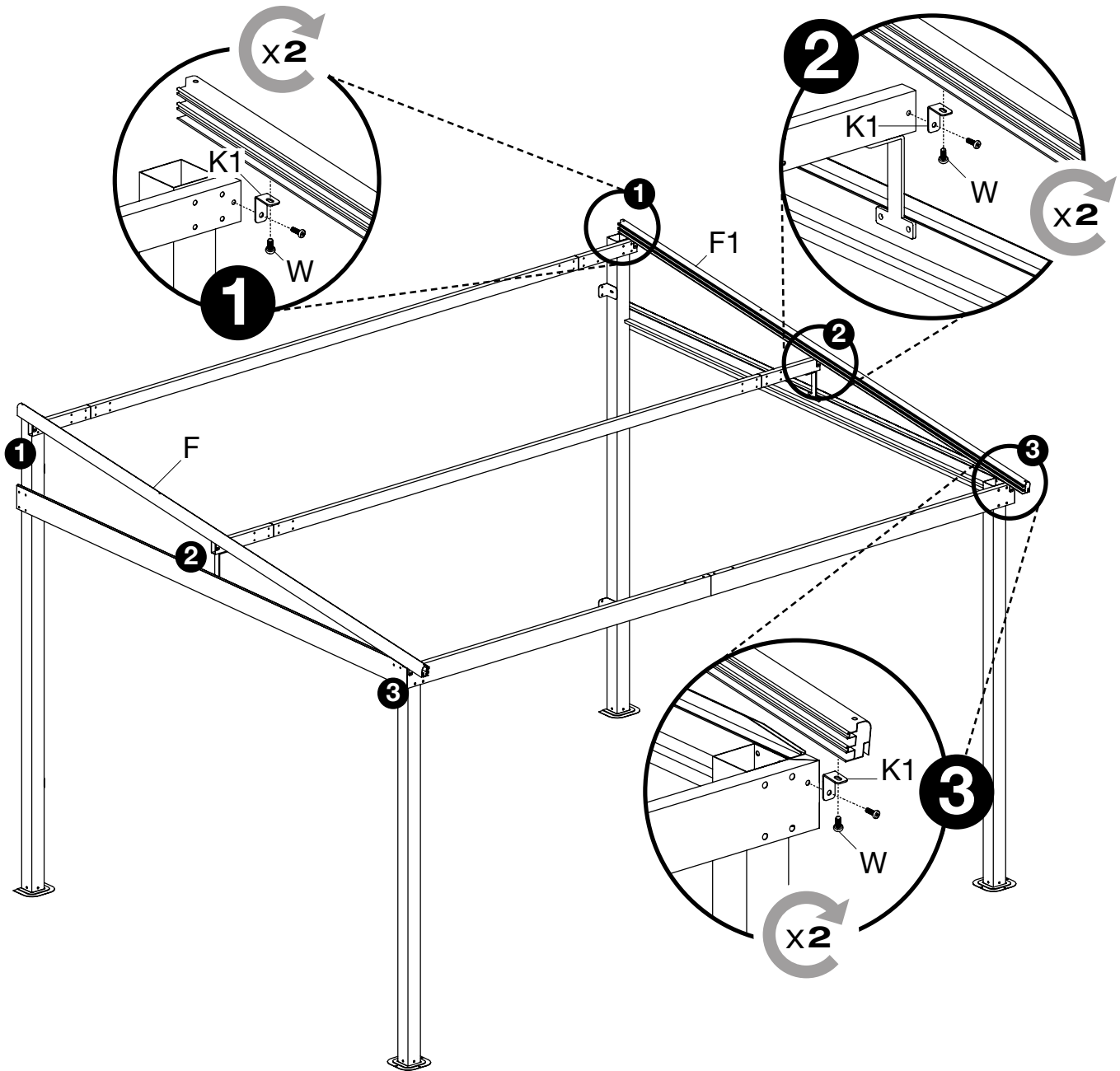

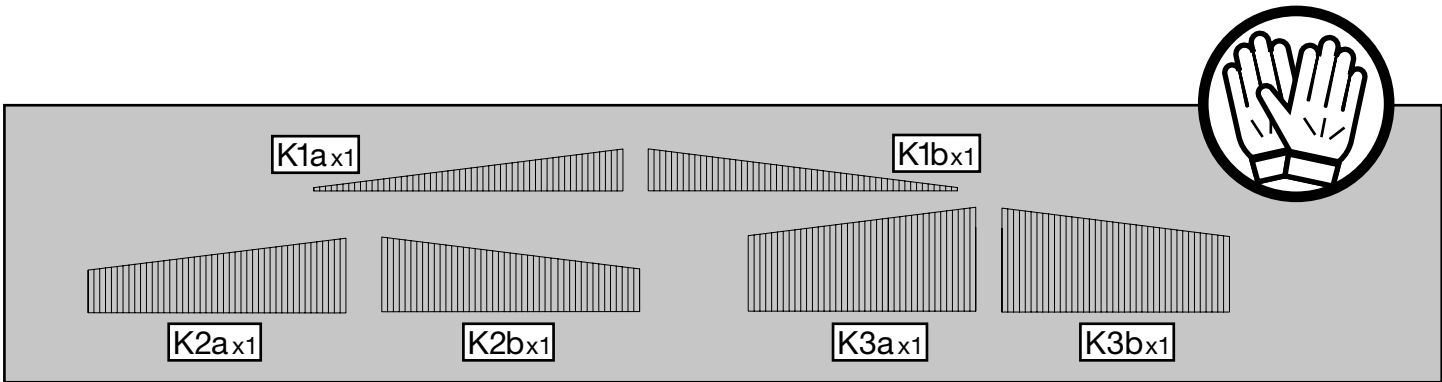
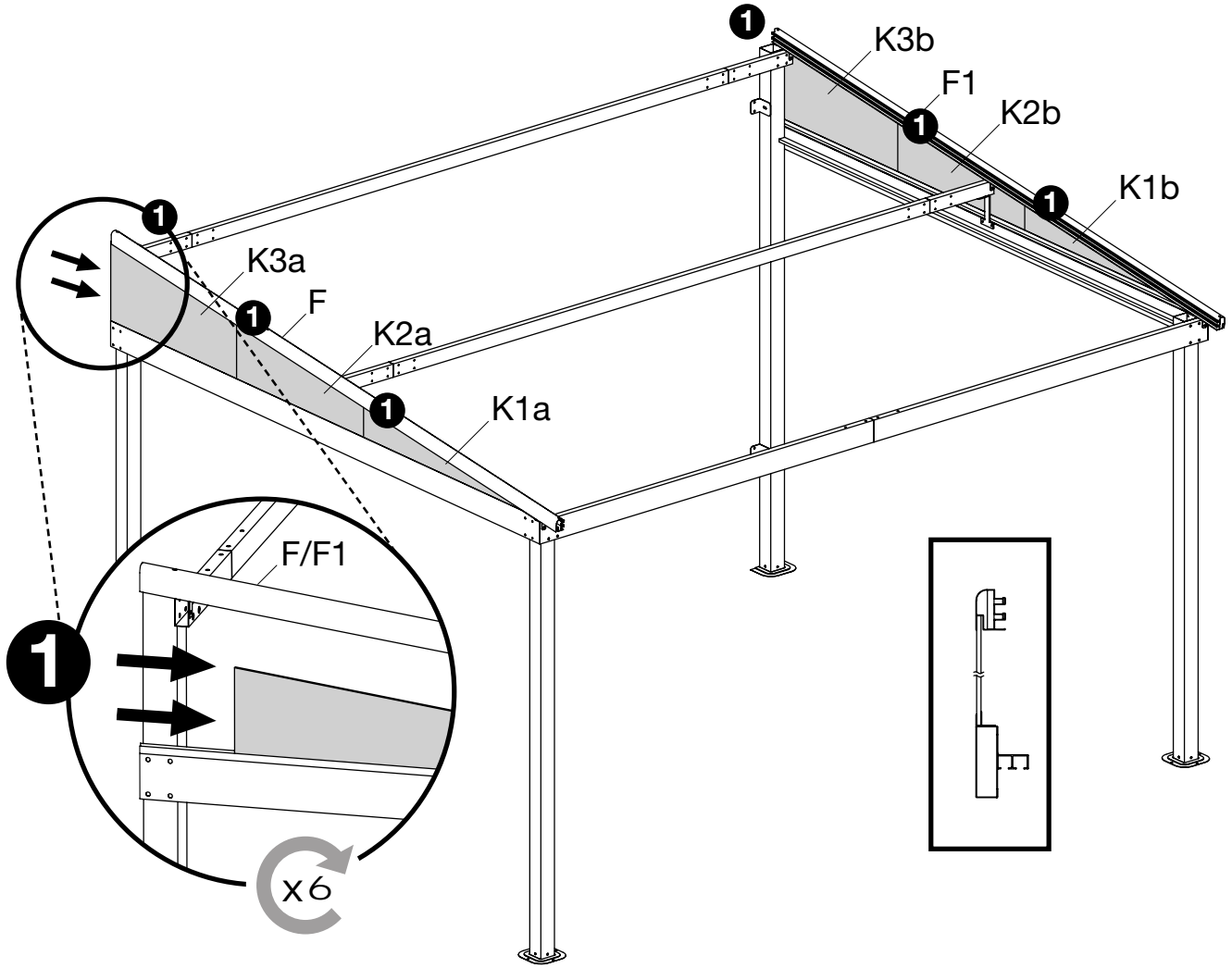

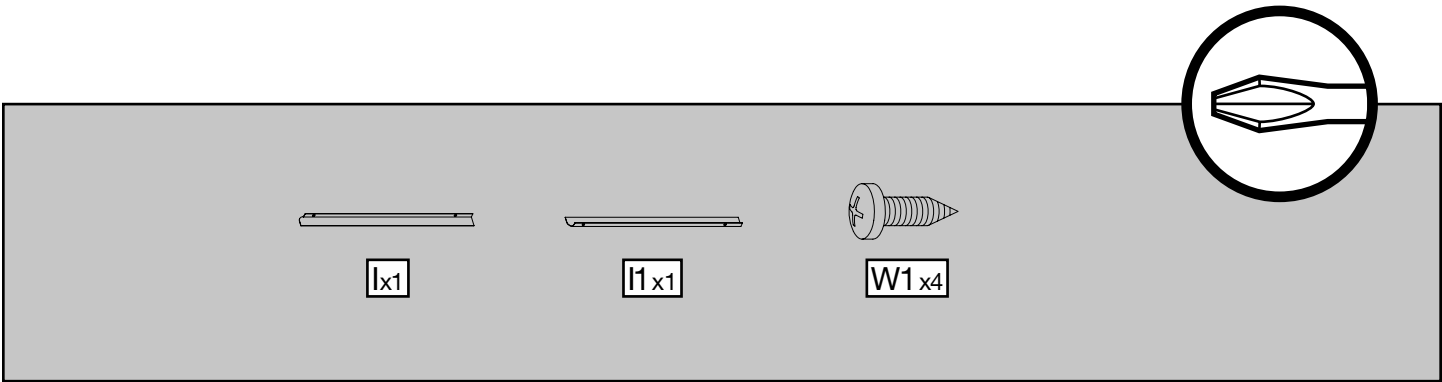
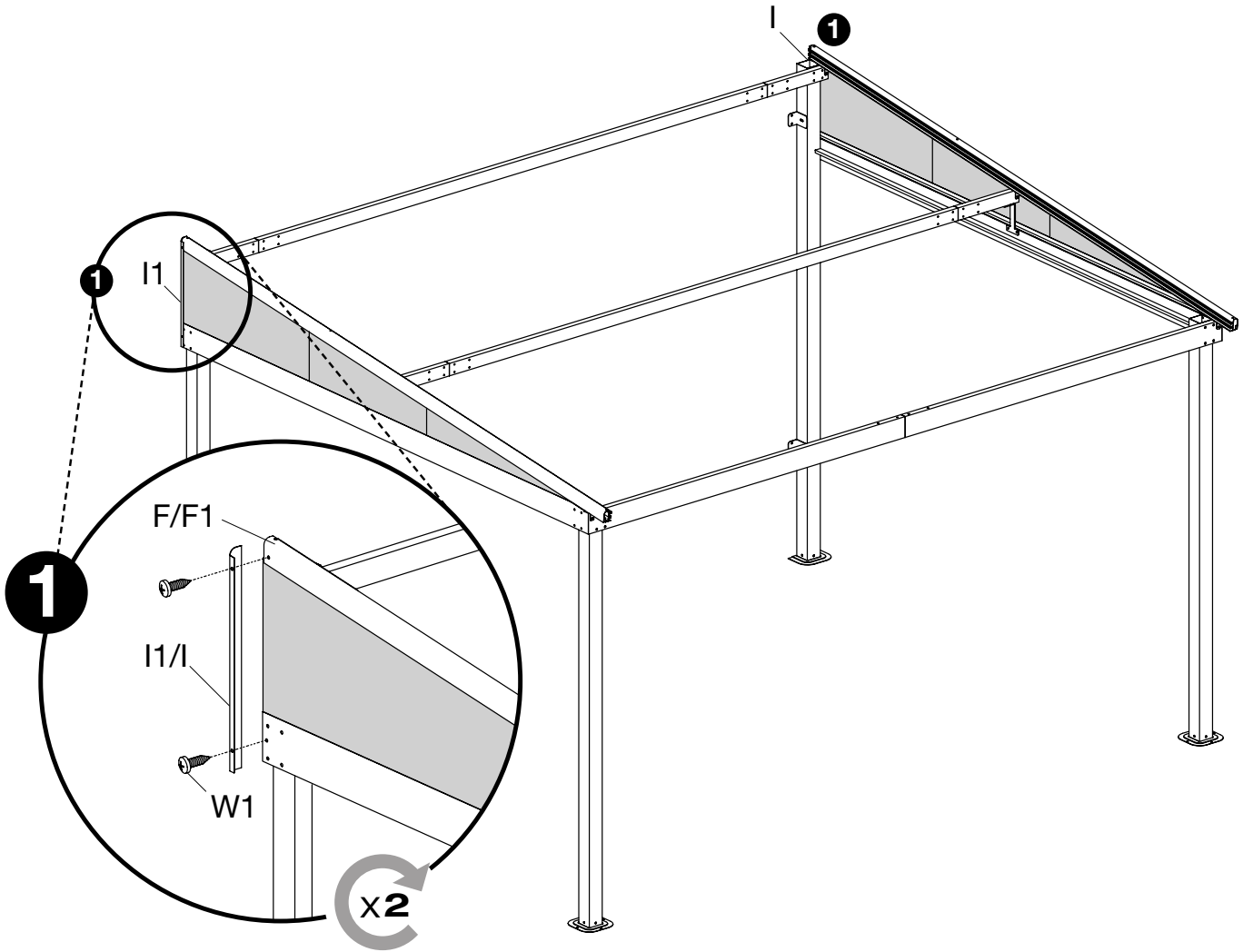

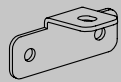
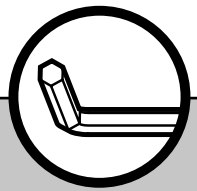
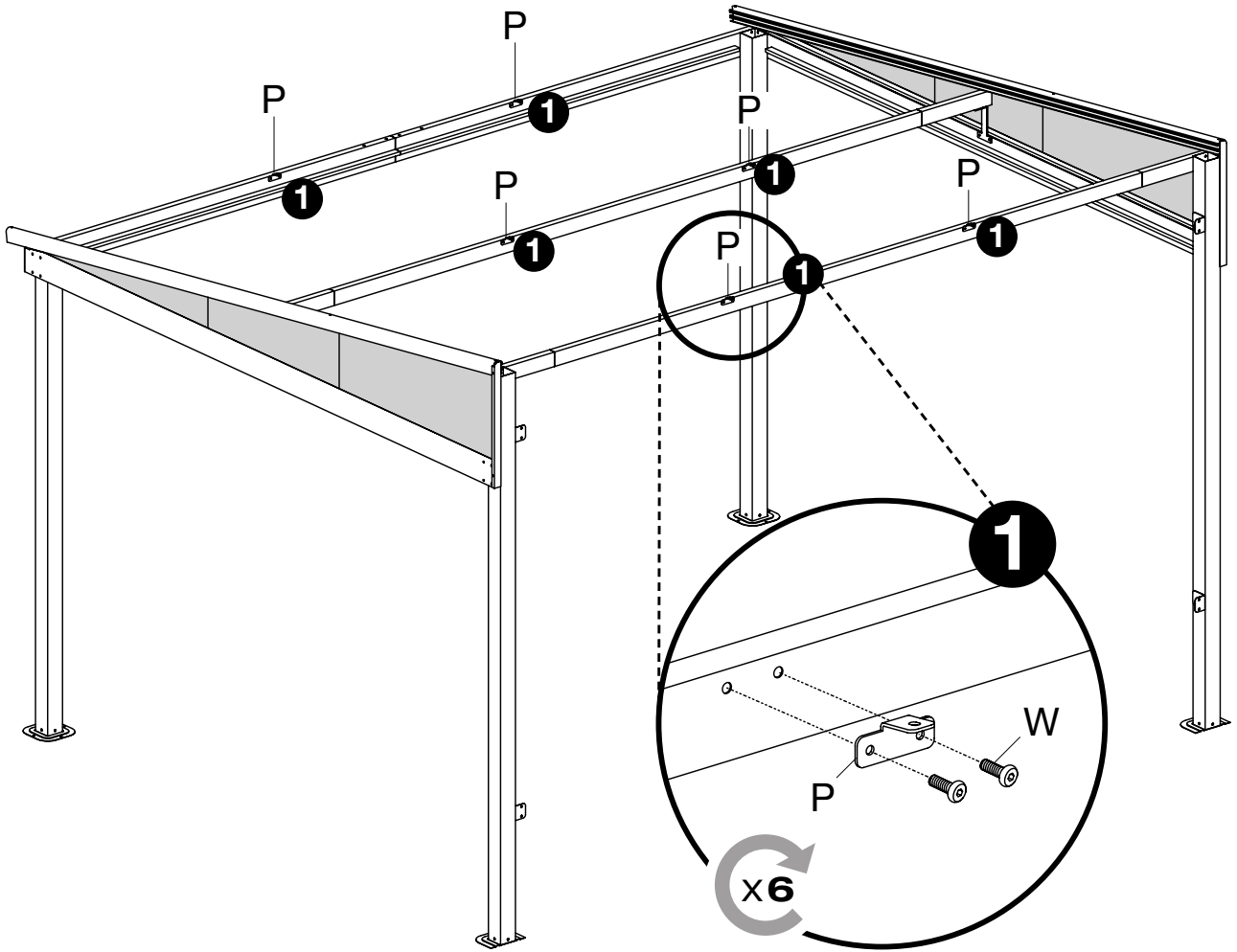

Px6

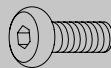

Wx12

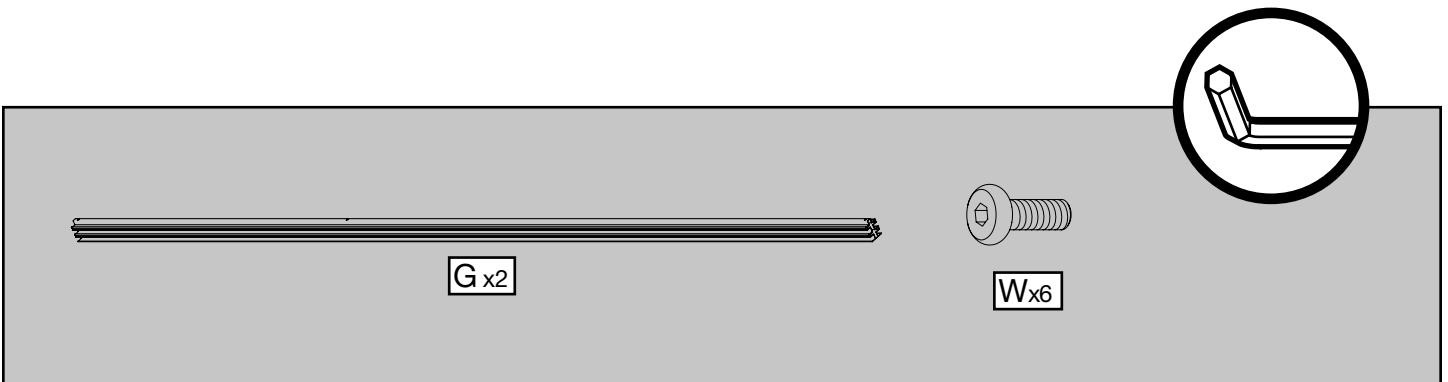
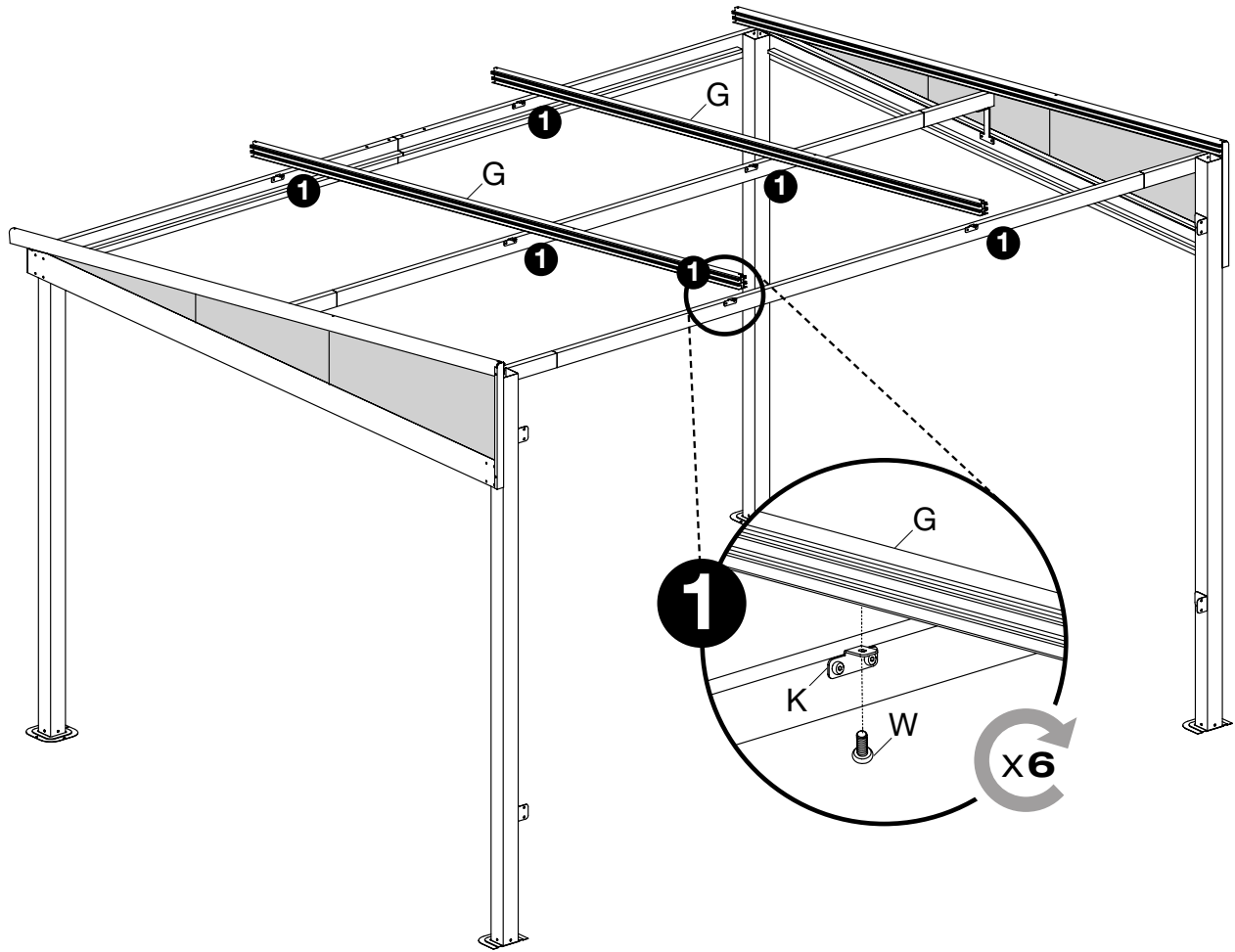

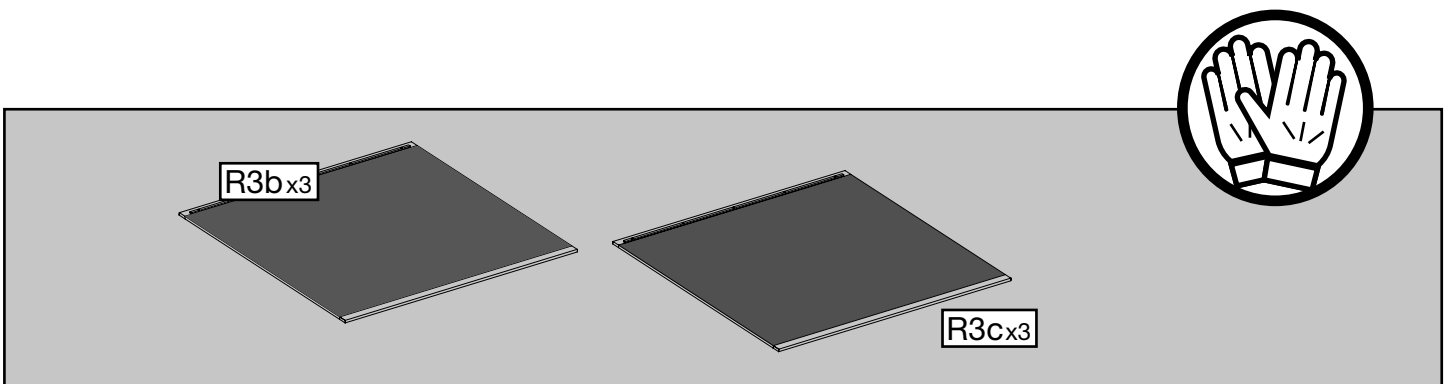
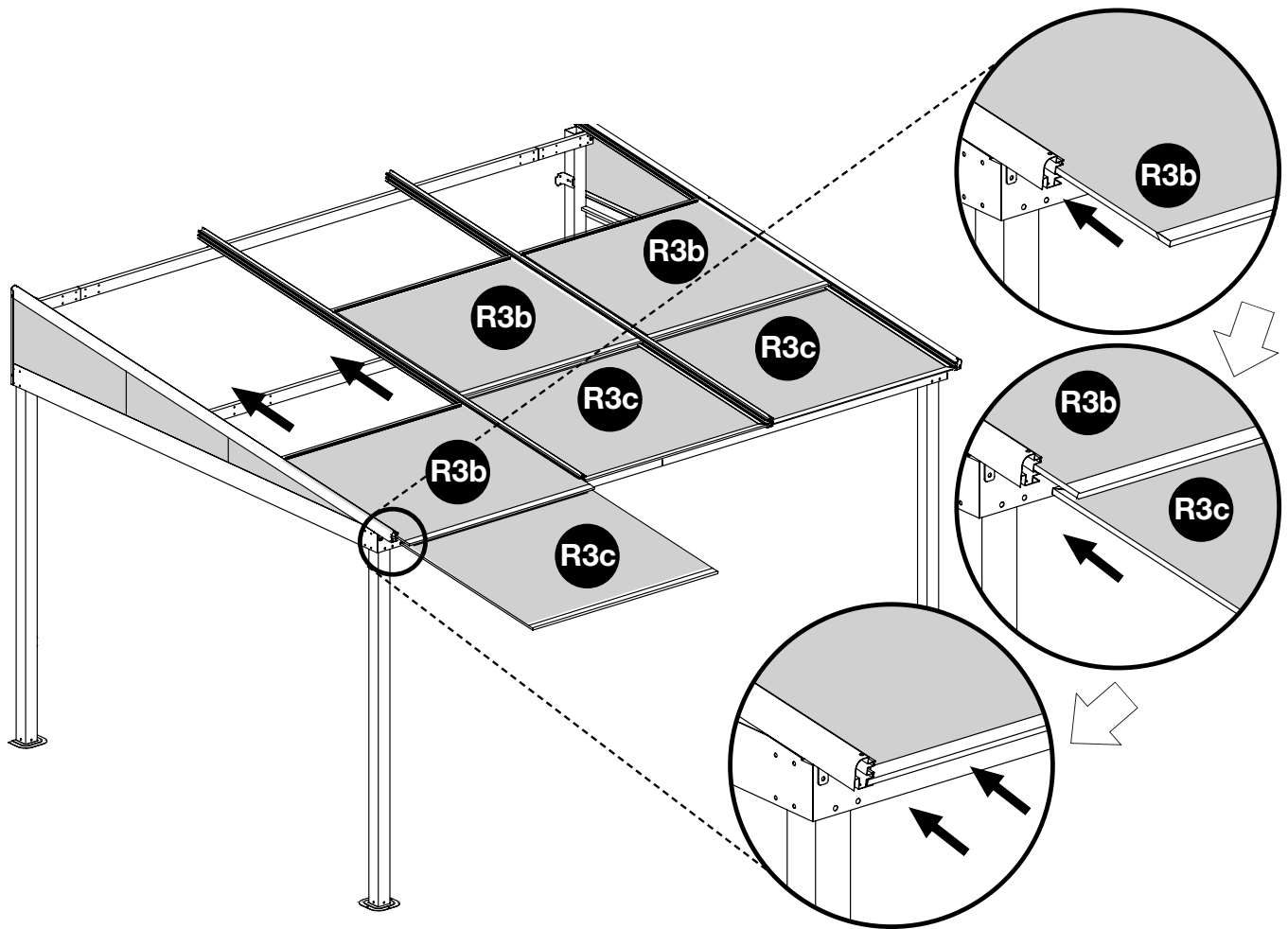

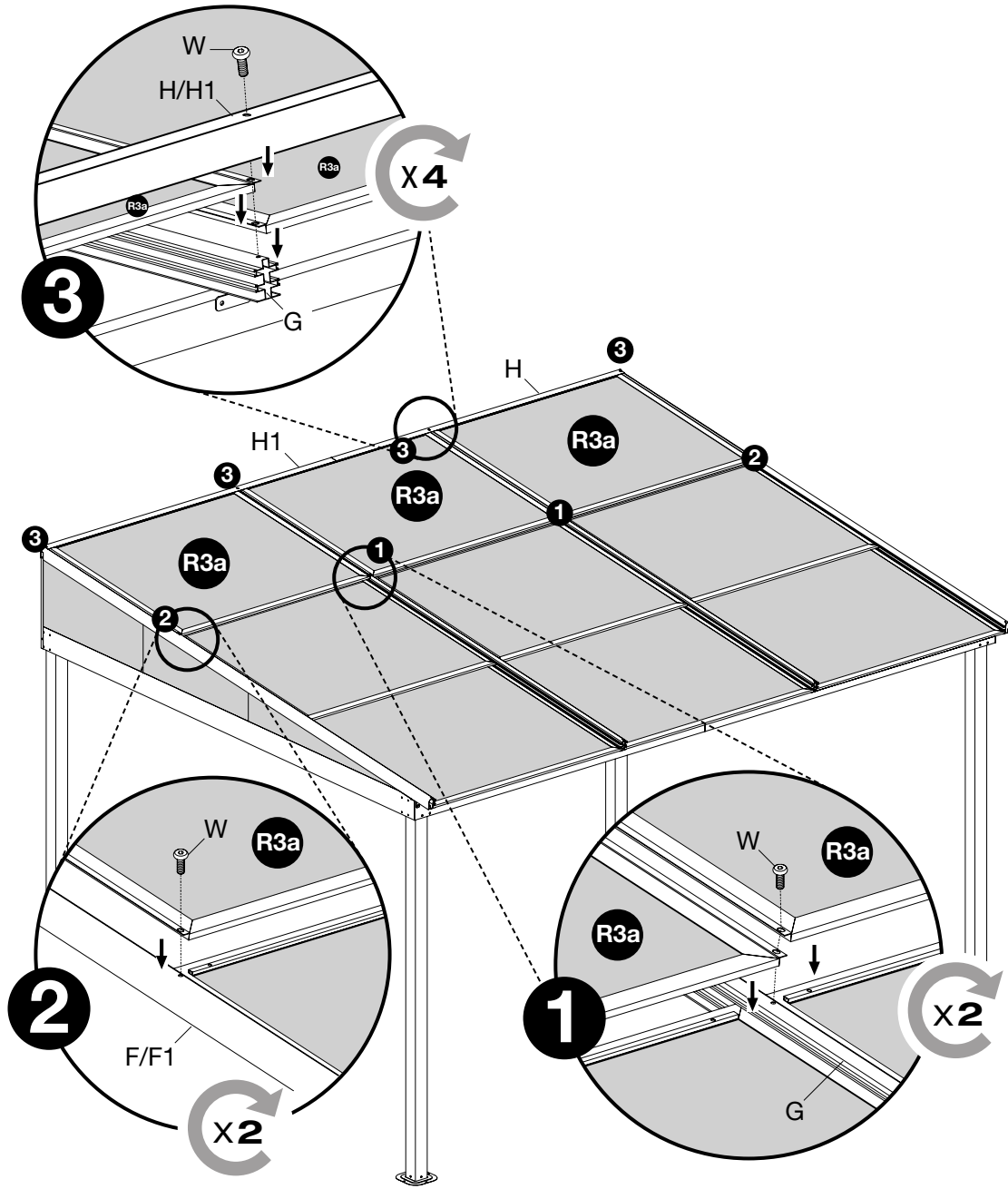

Hx1
H1x1
R3ax3
Wx8

Hand icon
Screwdriver icon

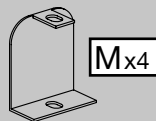
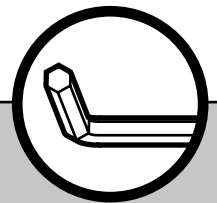
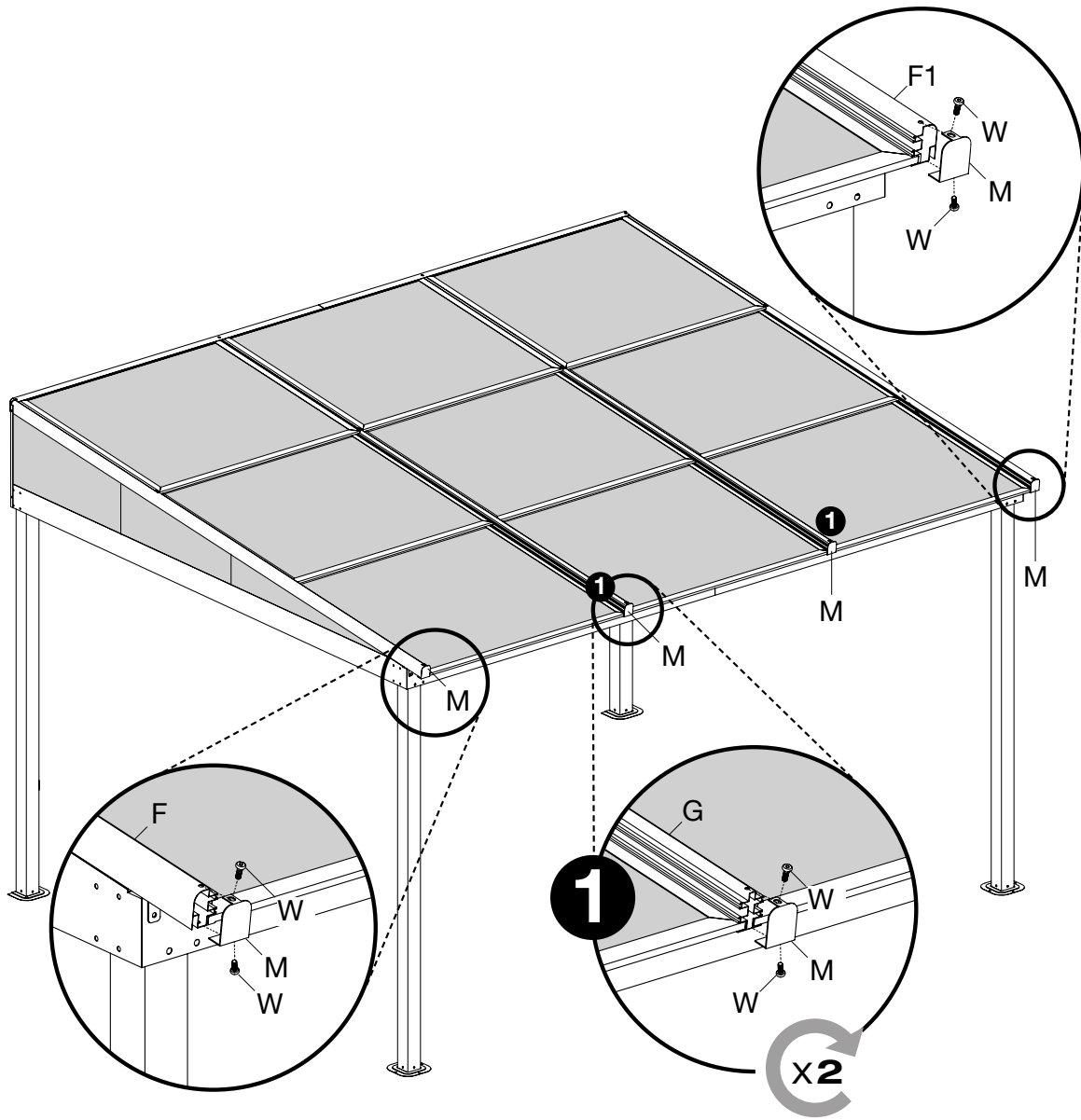

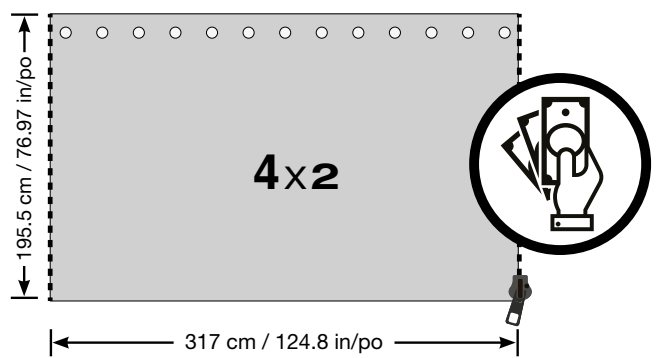
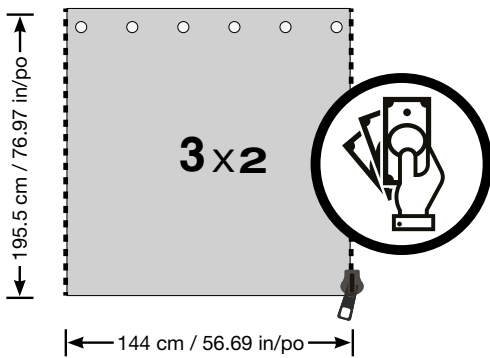
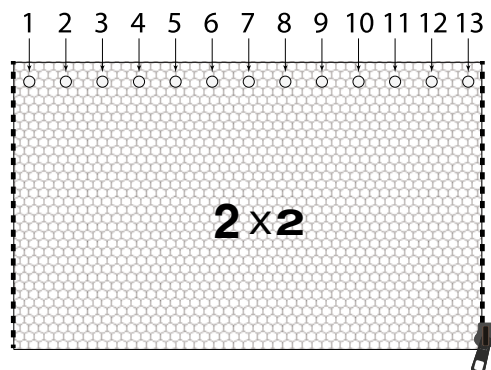
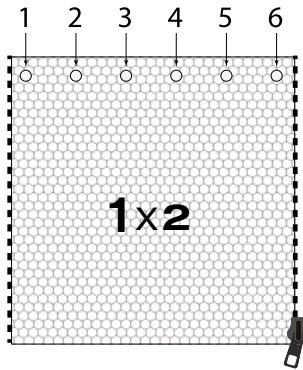
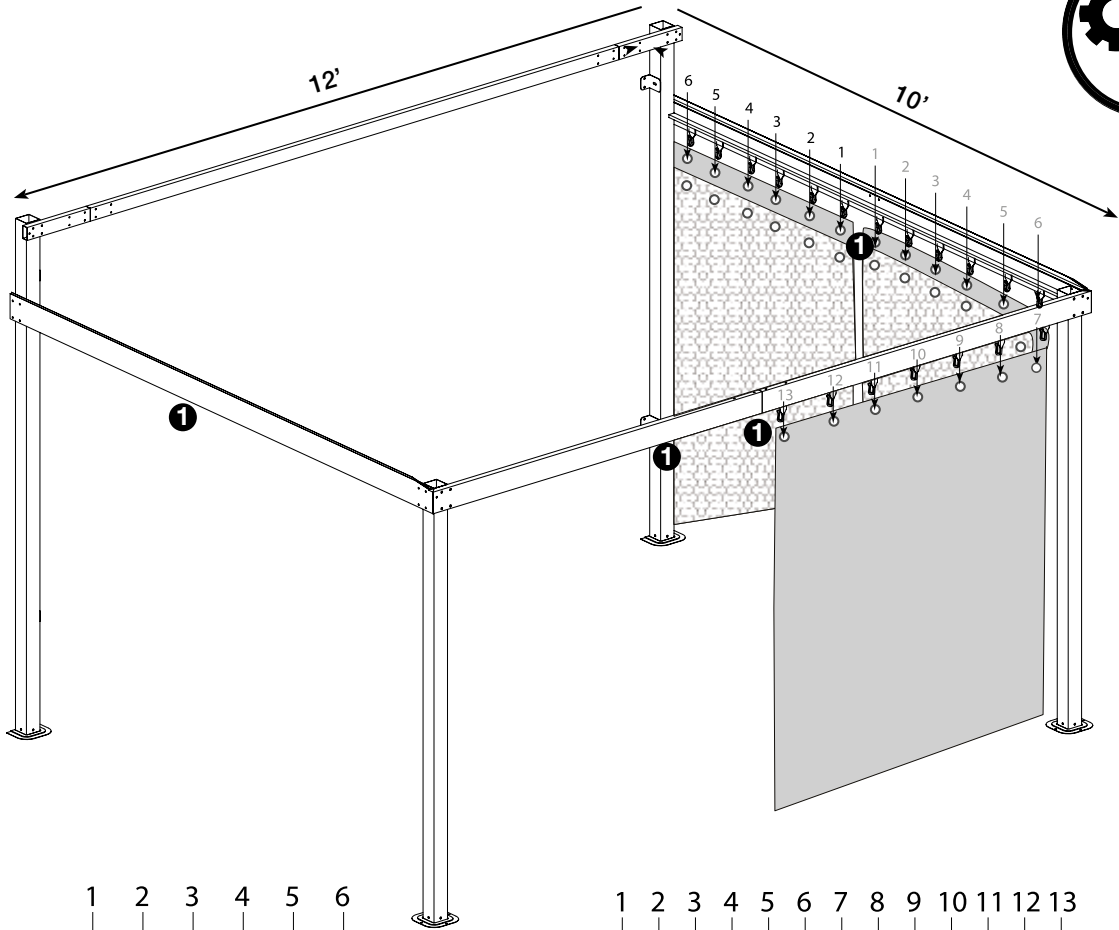
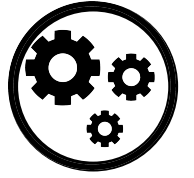

Register • Enregistrer • Regístrate
온라인 등록 • Registrieren

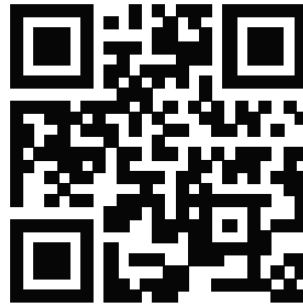

ShelterLogic.com/product-registration

<p>50NRTH GmbH Straßburgstraße 14-16 Germany 54516 Wittlich phone +49 (0) 6571 / 95 117- 0 Fax +49 (0) 6571 / 95 117- 98 www.50NRTH.com info@50NRTH.com</p>	A square QR code located to the right of the contact information text.
---	--

SOJAG ■ I