

Assembly Manual / Guide d'assemblage / Manual de ensamble / 조립설명서 / Montageanleitung

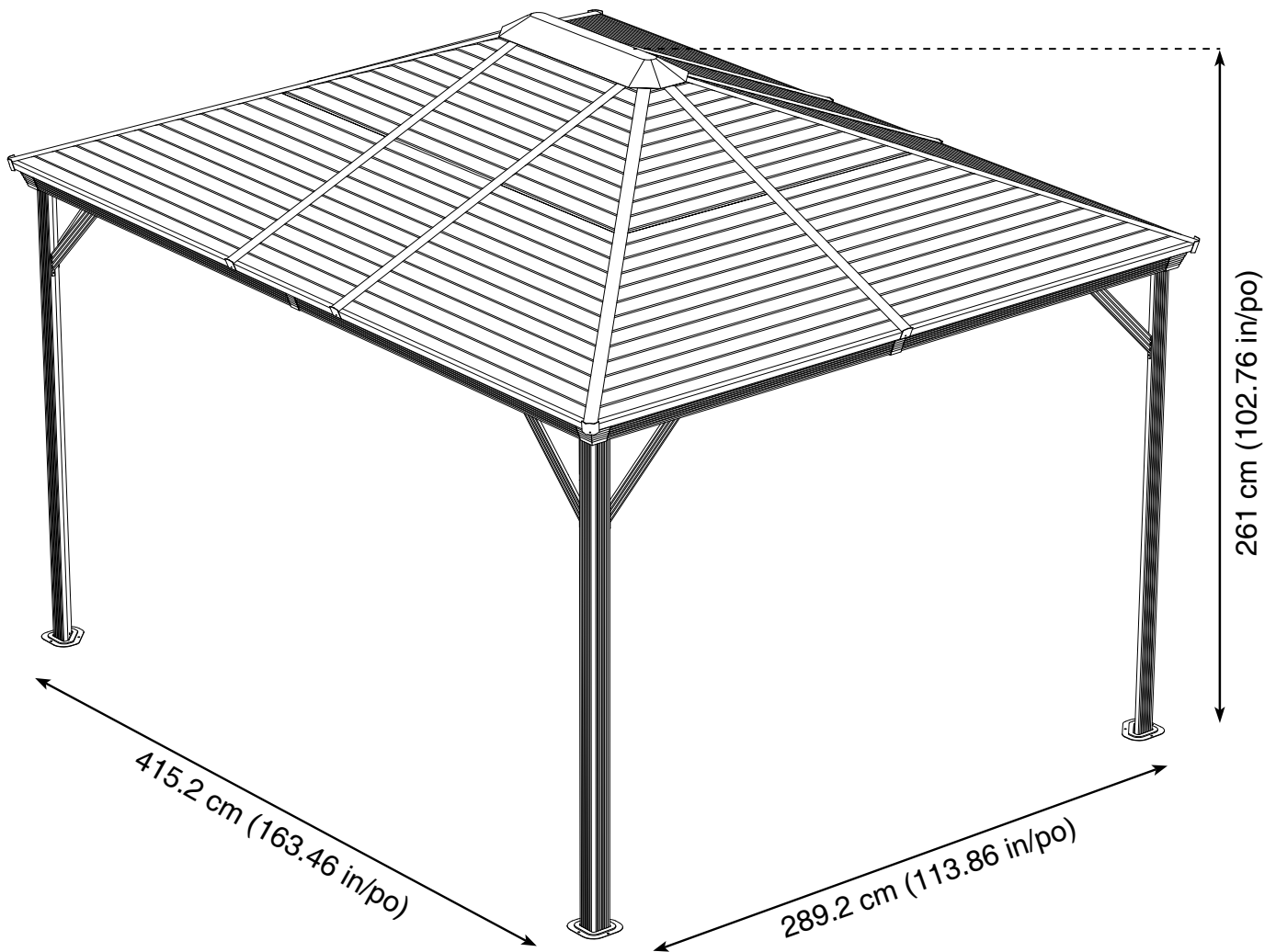

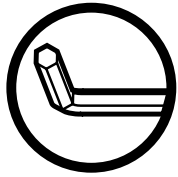

Use the hex keys in the box. / Utilisez les clés hexagonales fournies dans la boîte. / Utilice las llaves hexagonales en la caja. / 상자에 육각 키를 사용 하십시오. / Verwenden Sie die Sechskantschlüssel in der Box.

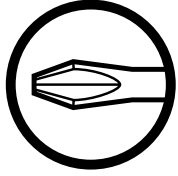

Please use a Phillips screwdriver. / Utilisez un tournevis de type Phillips / Por favor, use un destornillador Phillips. / 십자 드라이버를 사용 하십시오. / Bitte verwenden Sie einen Kreuzschraubenzieher.



You may need to use a drill for this step. / Vous pouvez avoir besoin d'utiliser une perceuse pour cette étape. / Puede que tenga que utilizar un taladro para este paso. / 이 단계에선 드릴을 사용해야 할 수도 있습니다. / Für diesen Schritt können Sie einen Bohrer verwenden.



Wearing protective gloves is recommended. / Le port de gants de protection est recommandé / El uso de guantes de protección se recomienda. / 보호 장갑을 착용 하는 것이 좋습니다. / Das Tragen von Schutzhandschuhen wird empfohlen.



Two or more people are required at this stage. / Deux personnes ou plus sont nécessaires à cette étape. / Dos o más personas se requieren en esta etapa. / 이 단계에서는 두 명 이상 이 필요합니다. / Für diesen Bauschritt sind 2 oder mehr Personen erforderlich.



Do not tighten screws all the way for now. / Ne pas visser fermement pour l'instant. / No atornille con firmeza por ahora. / 아직 나사를 단단히 조이지 마십시오. / Bitte die Schrauben zum jetzigen Zeitpunkt noch nicht fest anziehen.

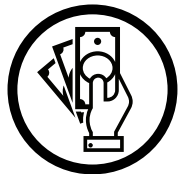

Sold separately. / Vendus séparément. / vendido en las opciones. / 옵션 판매 / Optional erhältlich

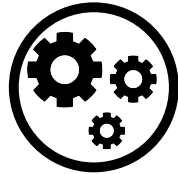

Optional step / Étape optionnelle / Paso opcional / 선택적 단계 / Optionaler Schritt

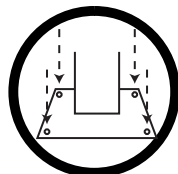

The gazebo must be anchored (hardware not included) / Le gazébo doit être ancré (quincaillerie non incluse) / El gazebo debe estar anclado (herramientas no incluidas) / gaze보를 반드시 바닥에 고정 시키세요. (고정 나사 부품 미포함) / Muss am Boden verankert werden, Befestigungsmaterial nicht im Lieferumfang enthalten

T X 8 (+2)

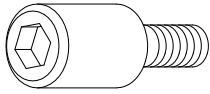

U X 16 (+2)

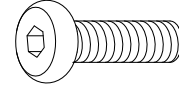

U1 X 40 (+8)



U2 X 2 (+1)

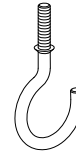

U3 X 1 (+1)

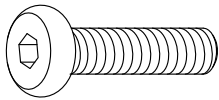

V X 92 (+10)

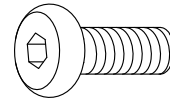

V1 X 16 (+2)

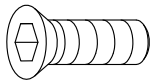

V2 X 20 (+2)

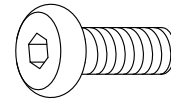

W X 34 (+4)

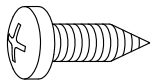

W1 X 16 (+2)

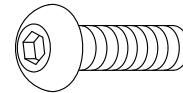

Y X 1

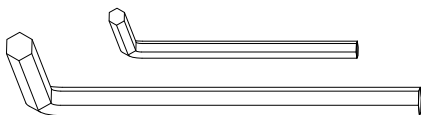

Y1 X 44 (+4)

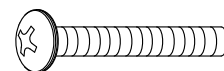

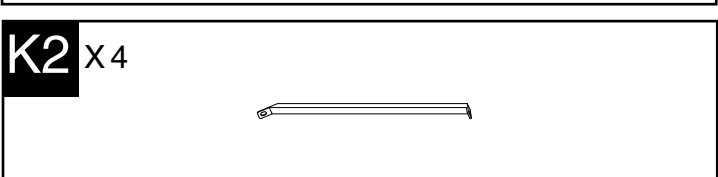
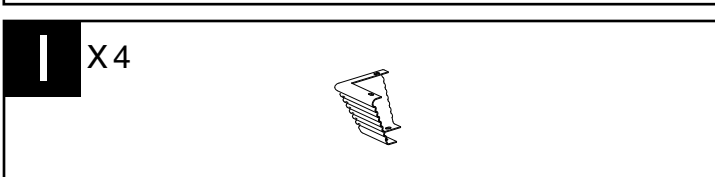
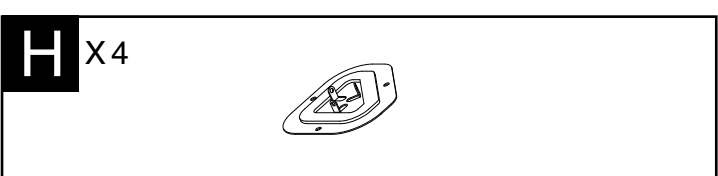
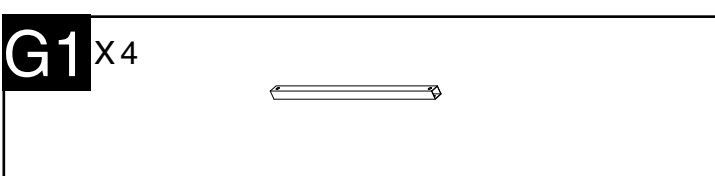
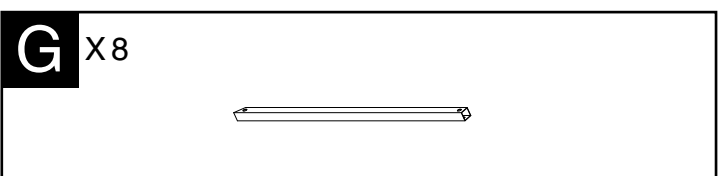
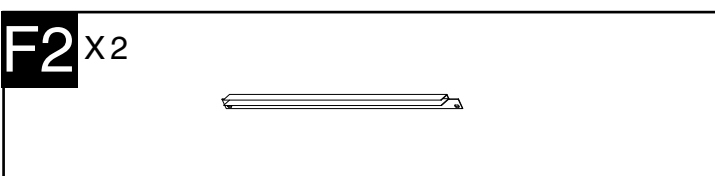
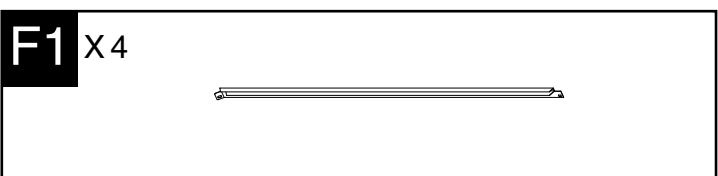
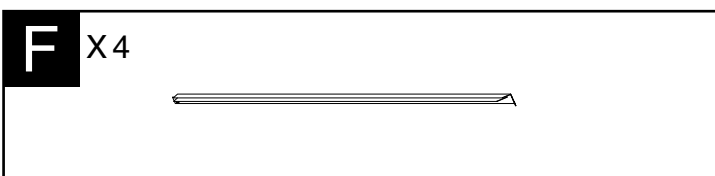
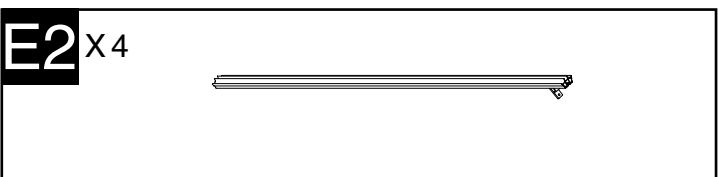
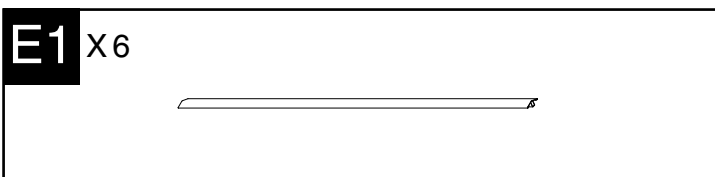
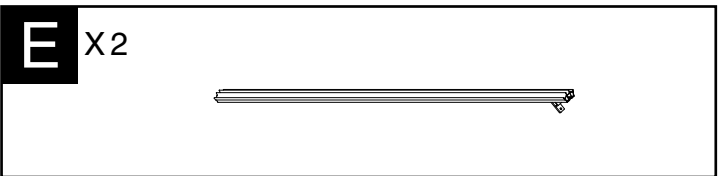
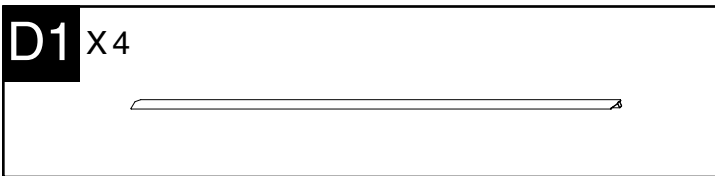
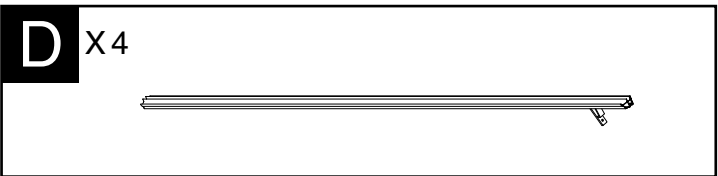
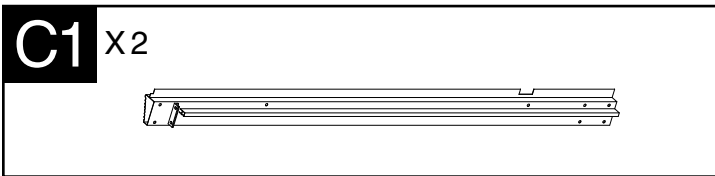
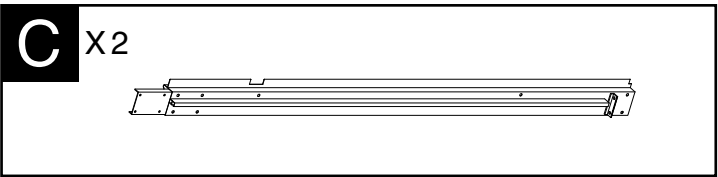
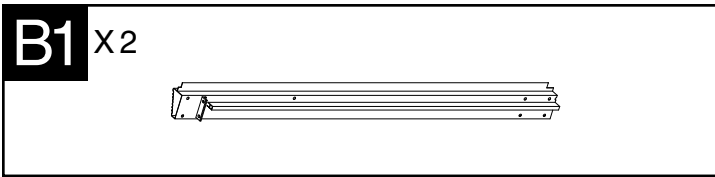
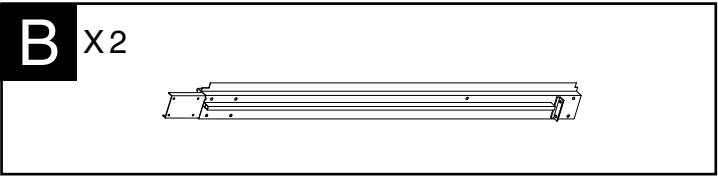

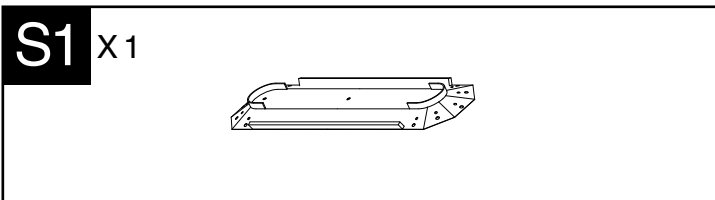
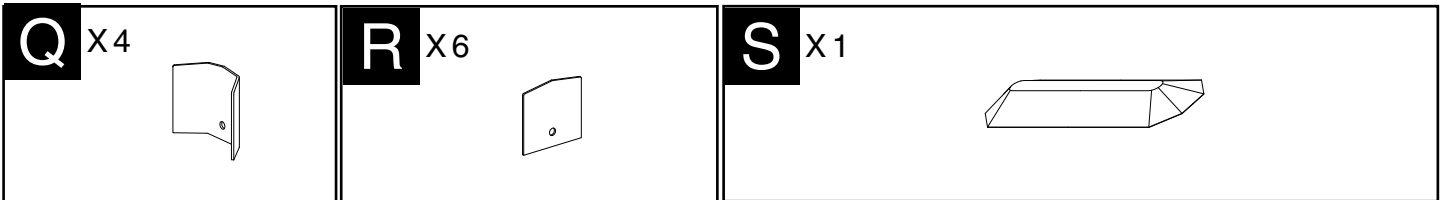
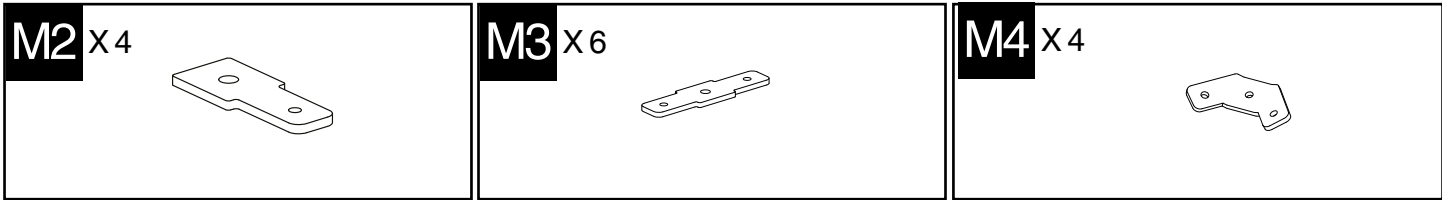
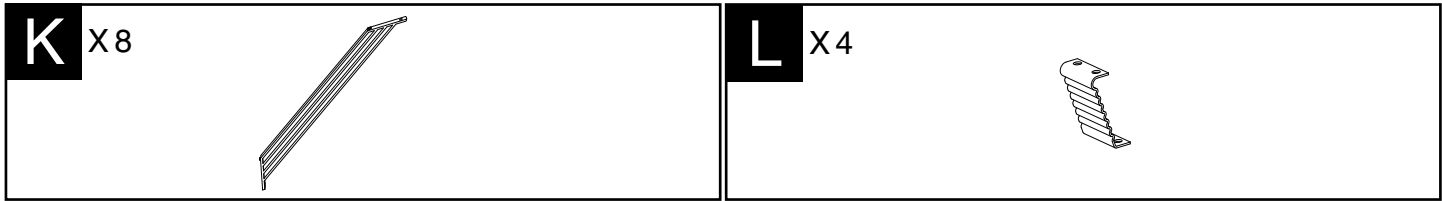
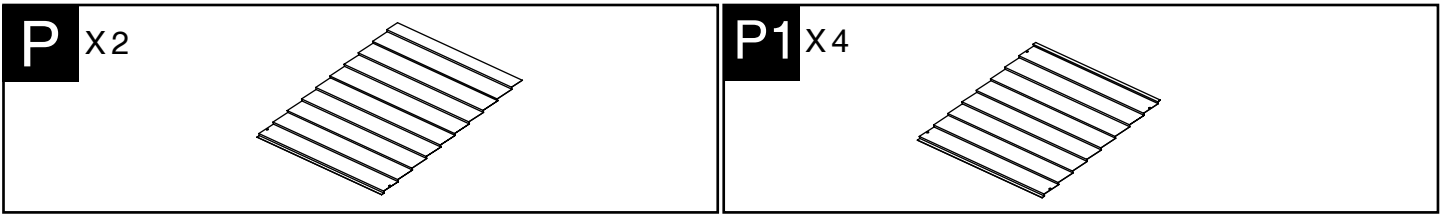
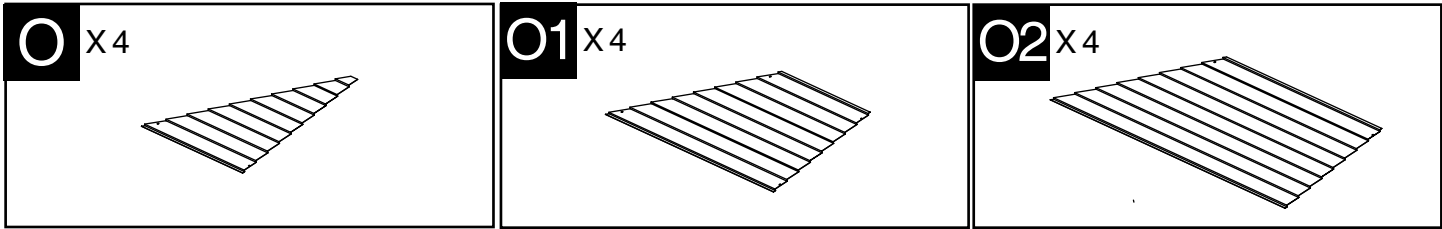
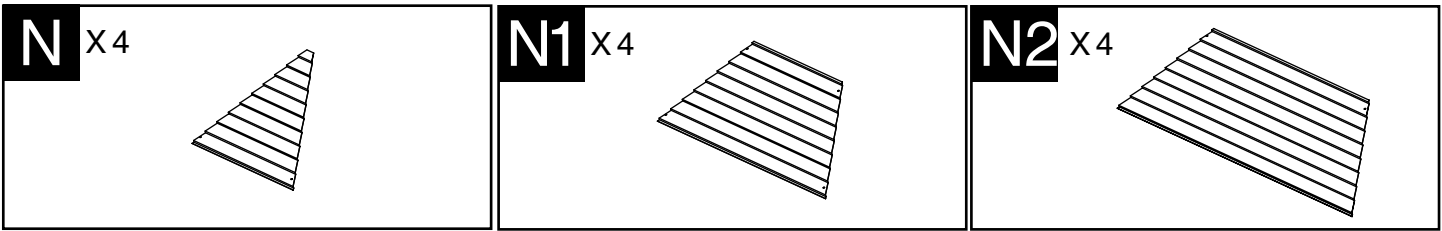

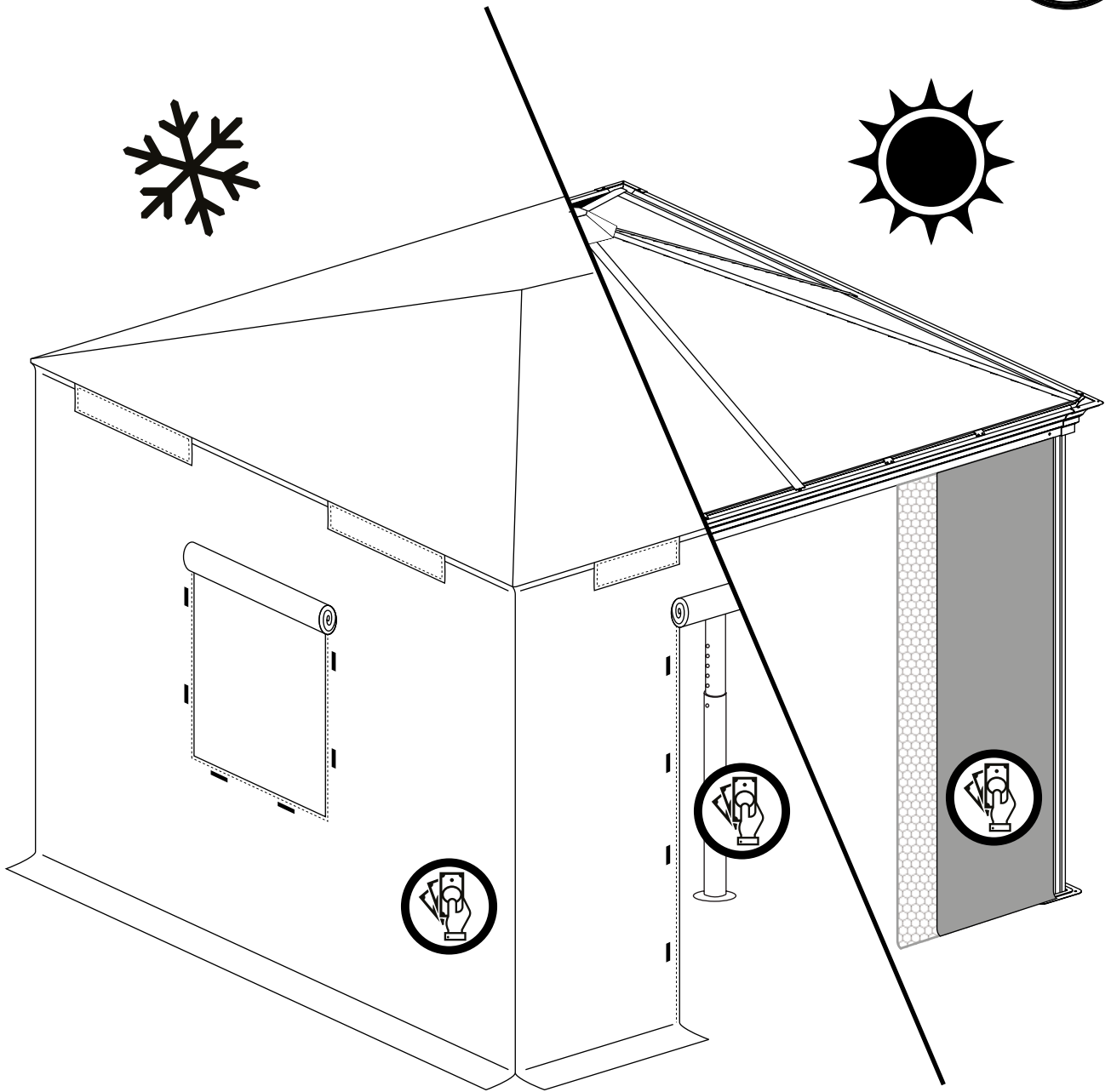
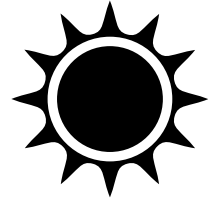
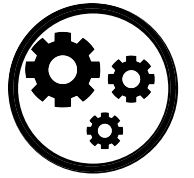
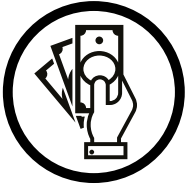

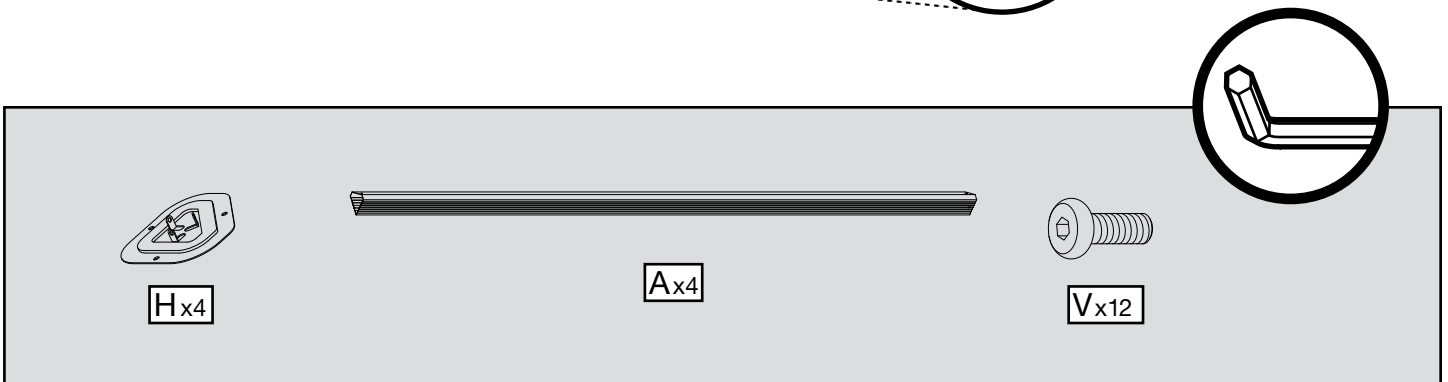
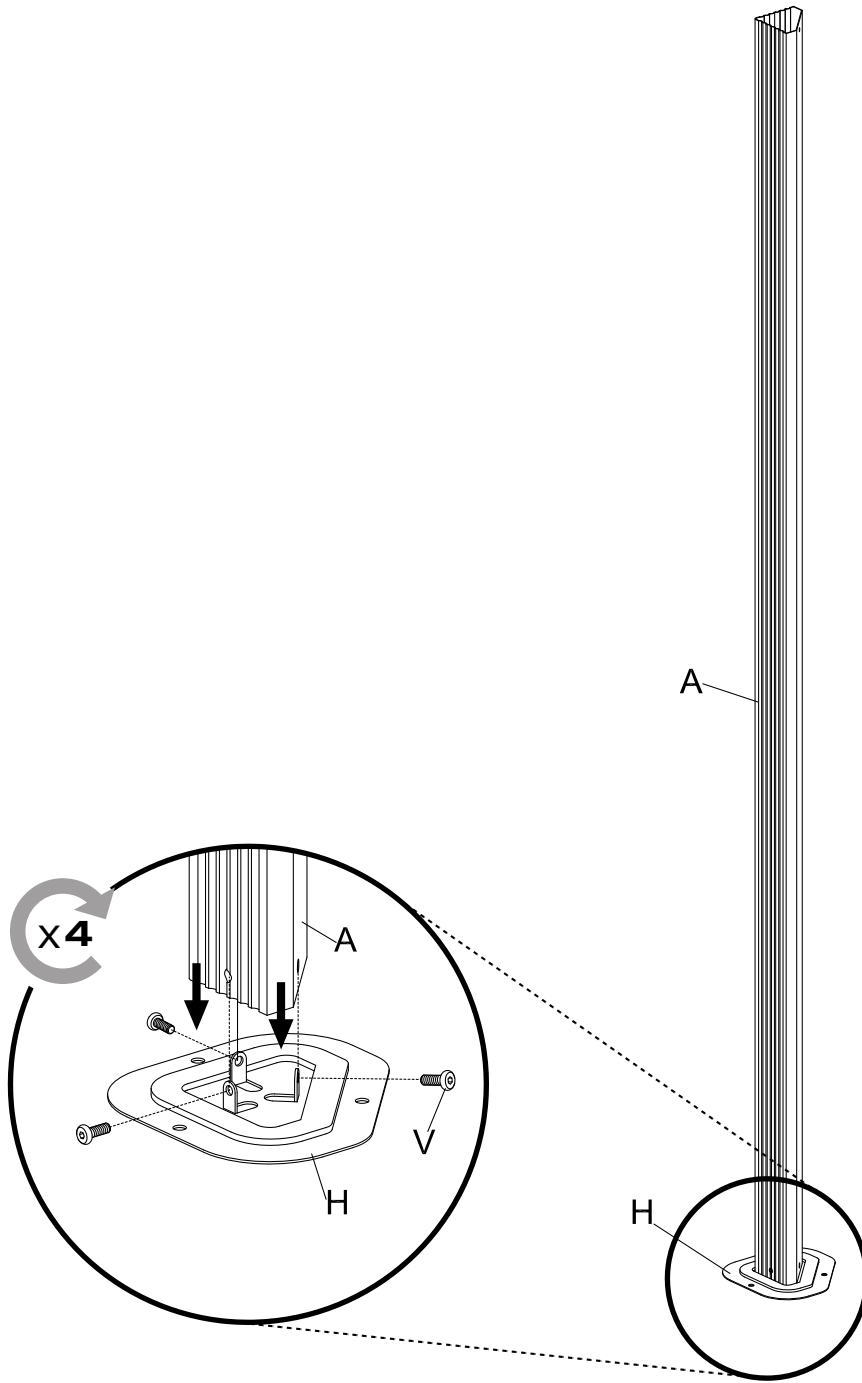

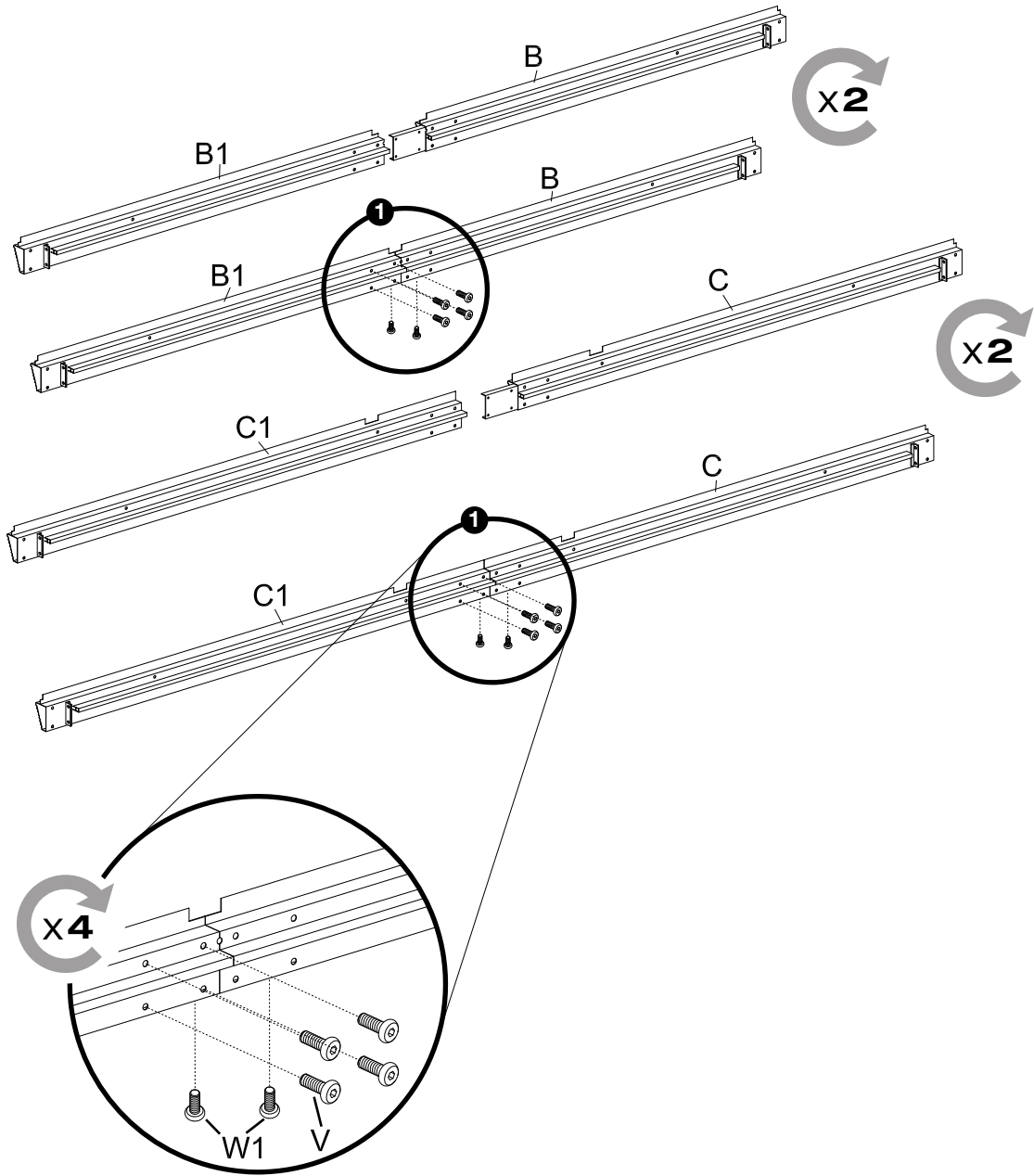

Parts list diagram showing the required components and their quantities:

- Bx2**: Two units of component B.
- B1x2**: Two units of component B1.
- Cx2**: Two units of component C.
- C1x2**: Two units of component C1.
- Vx16**: Sixteen units of part V.
- W1x8**: Eight units of part W1.

A circular icon shows a corner bracket component.

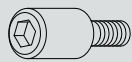
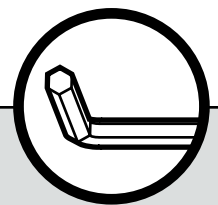
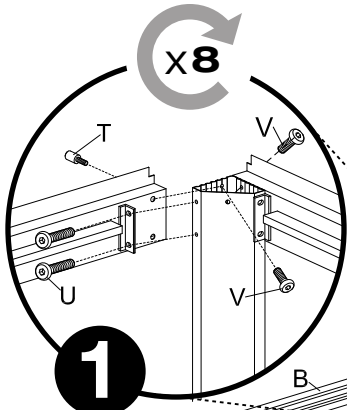
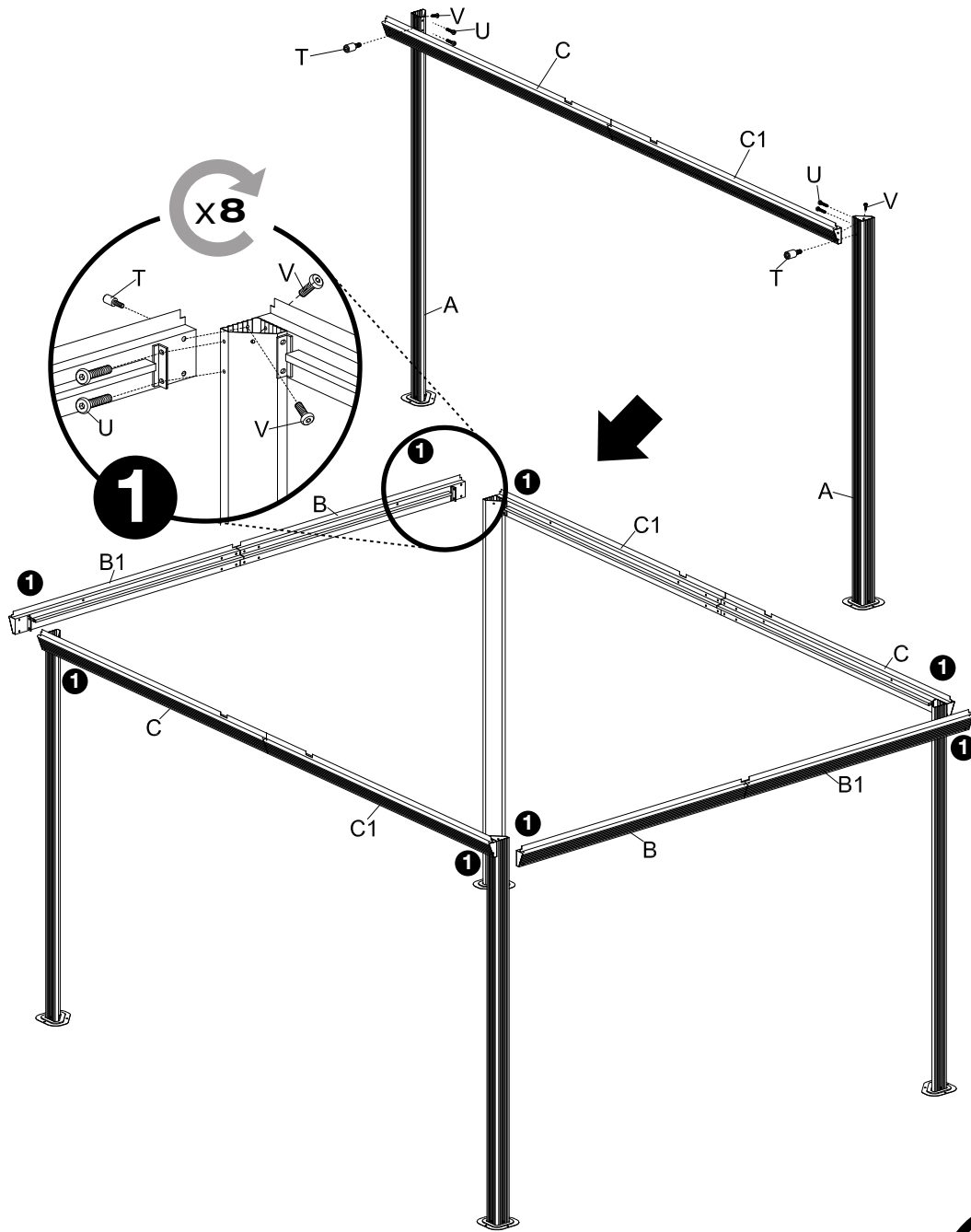

Tx8

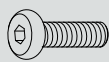

Ux16

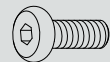

Vx8

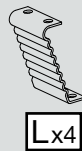
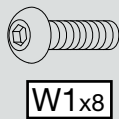
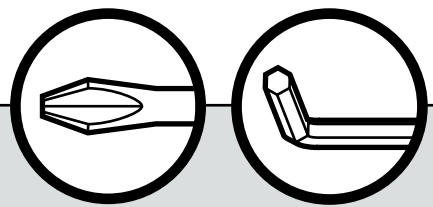
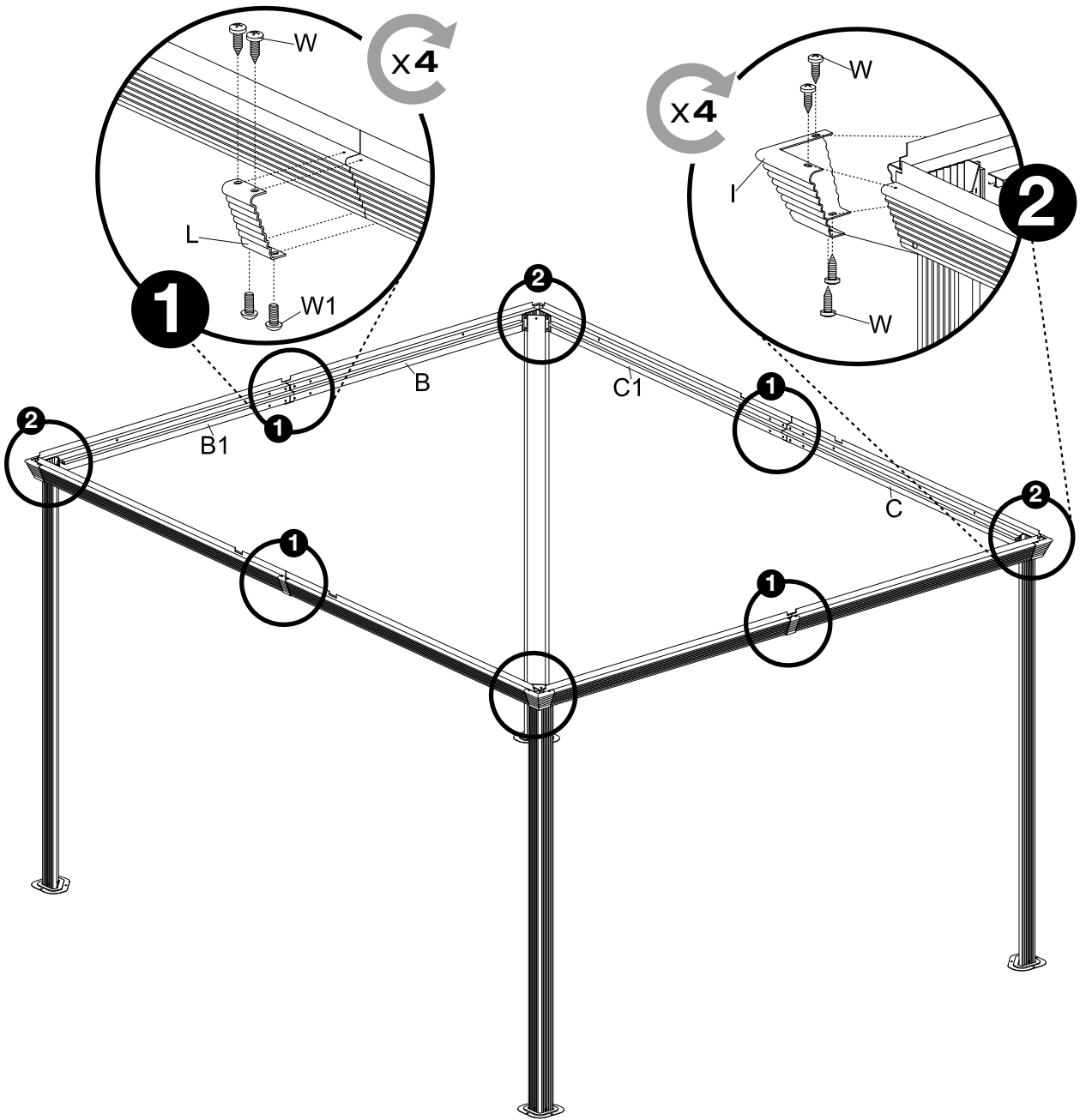

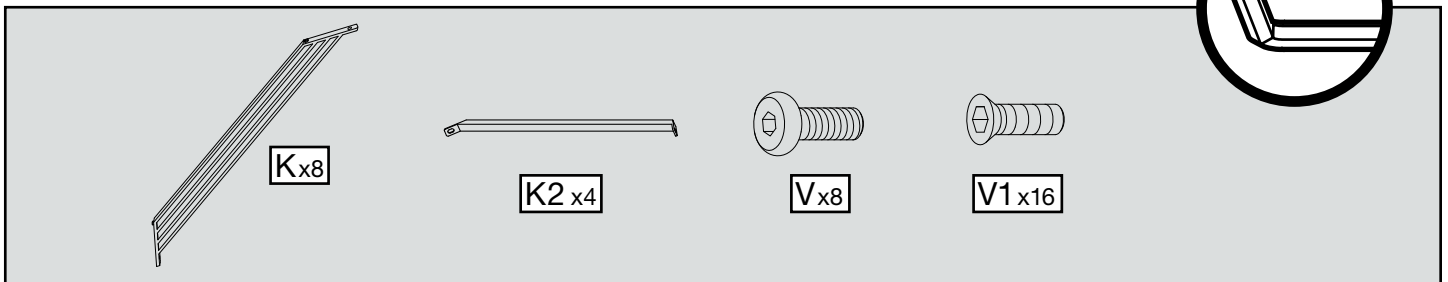
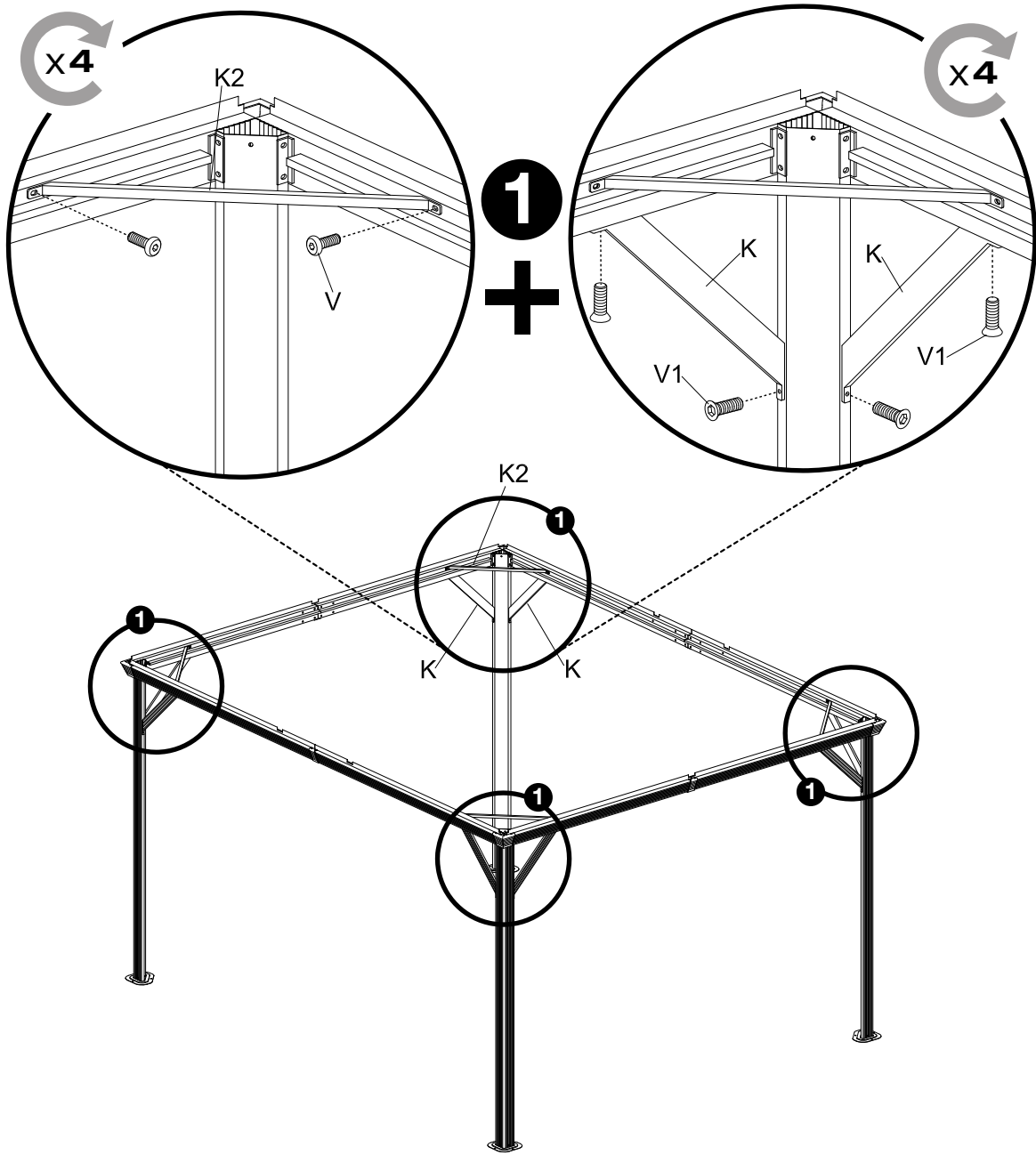

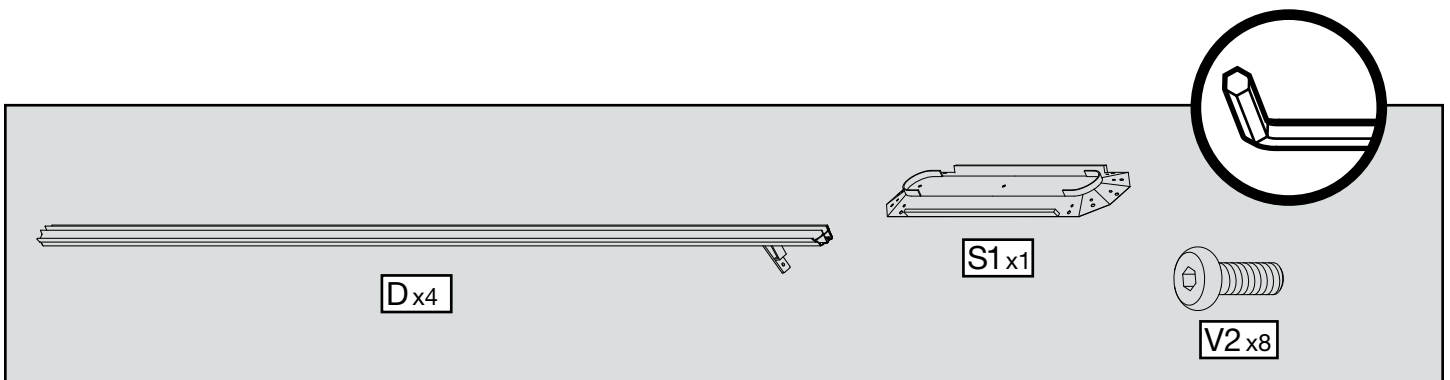
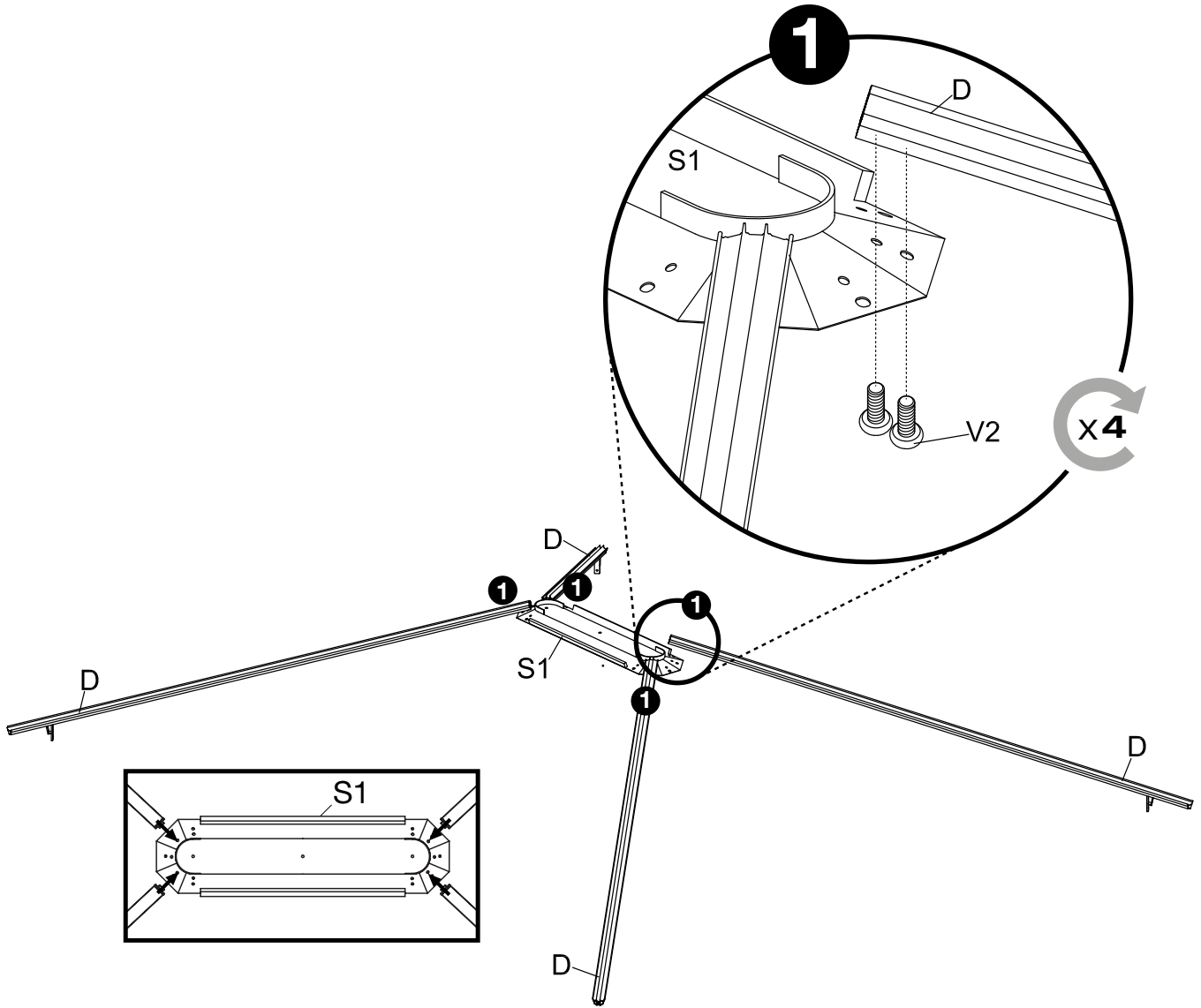

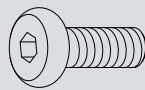
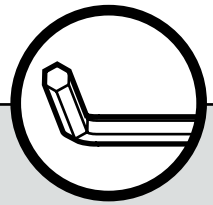
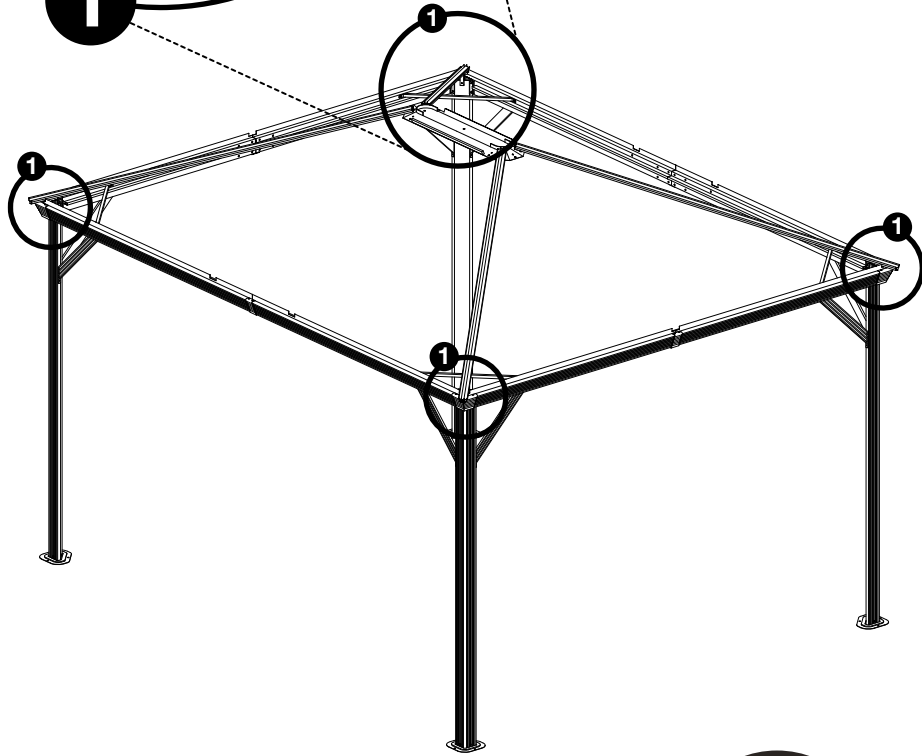
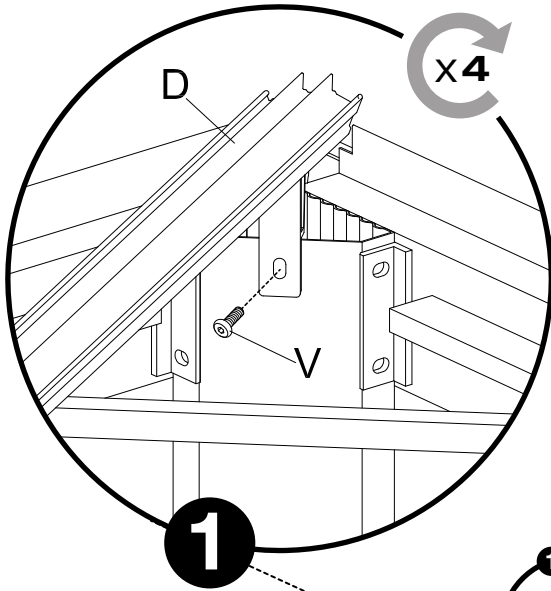

Vx4

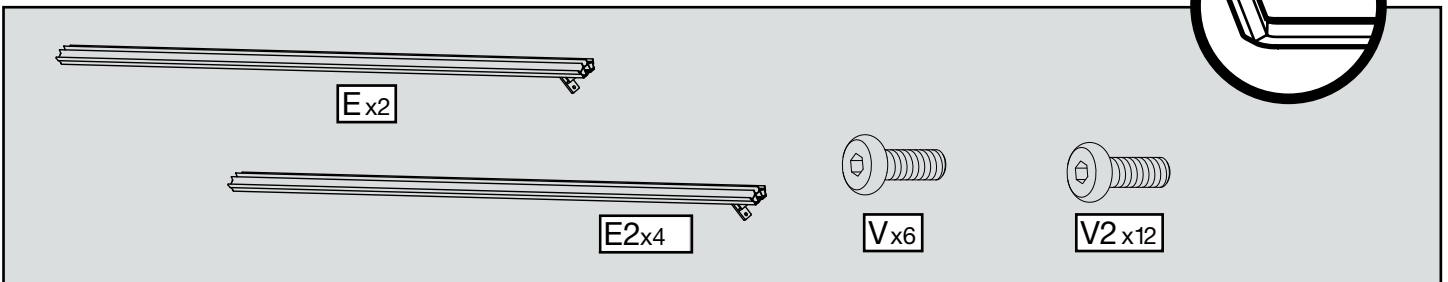
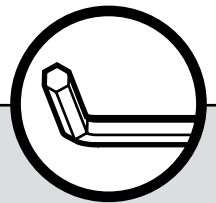
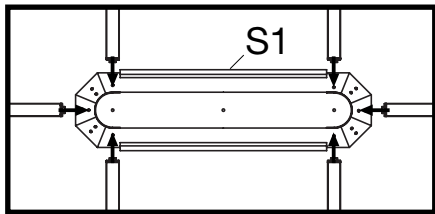
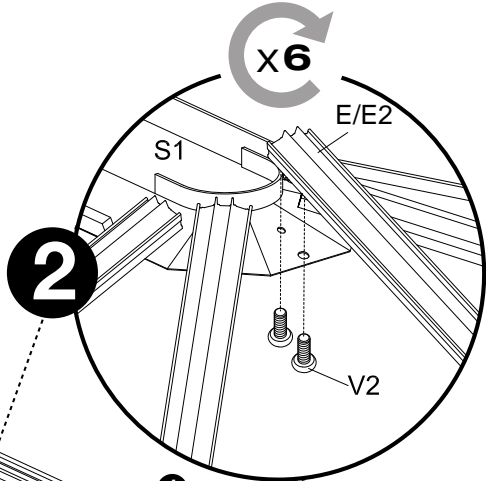
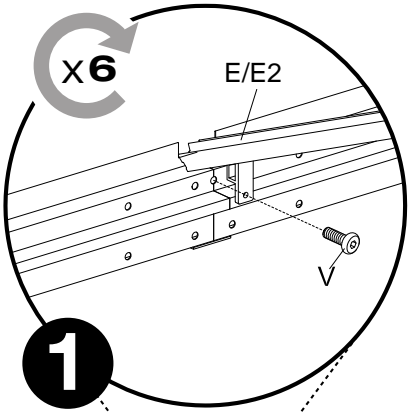
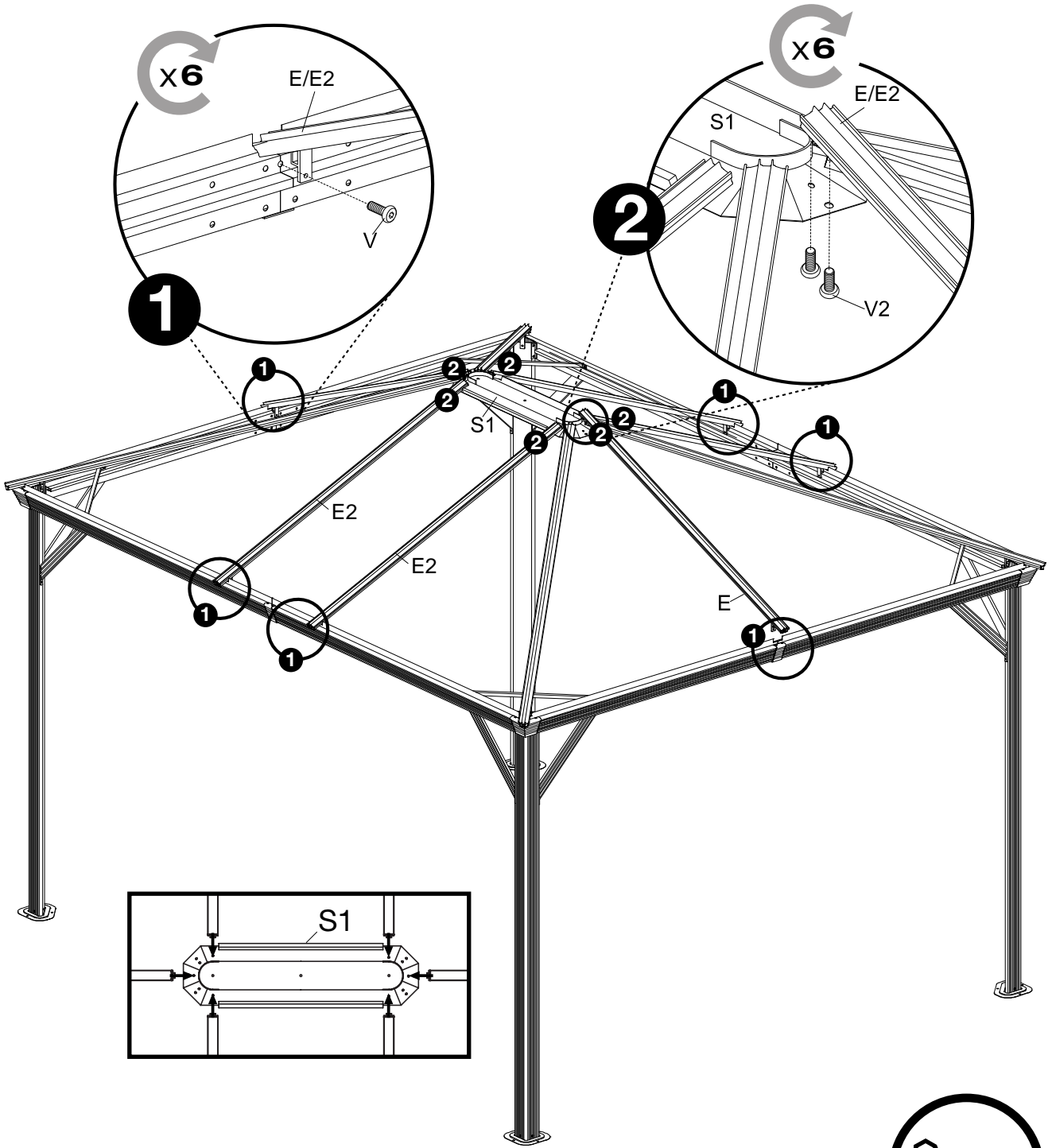

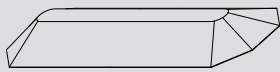
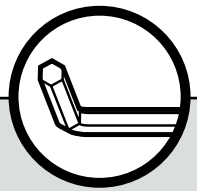
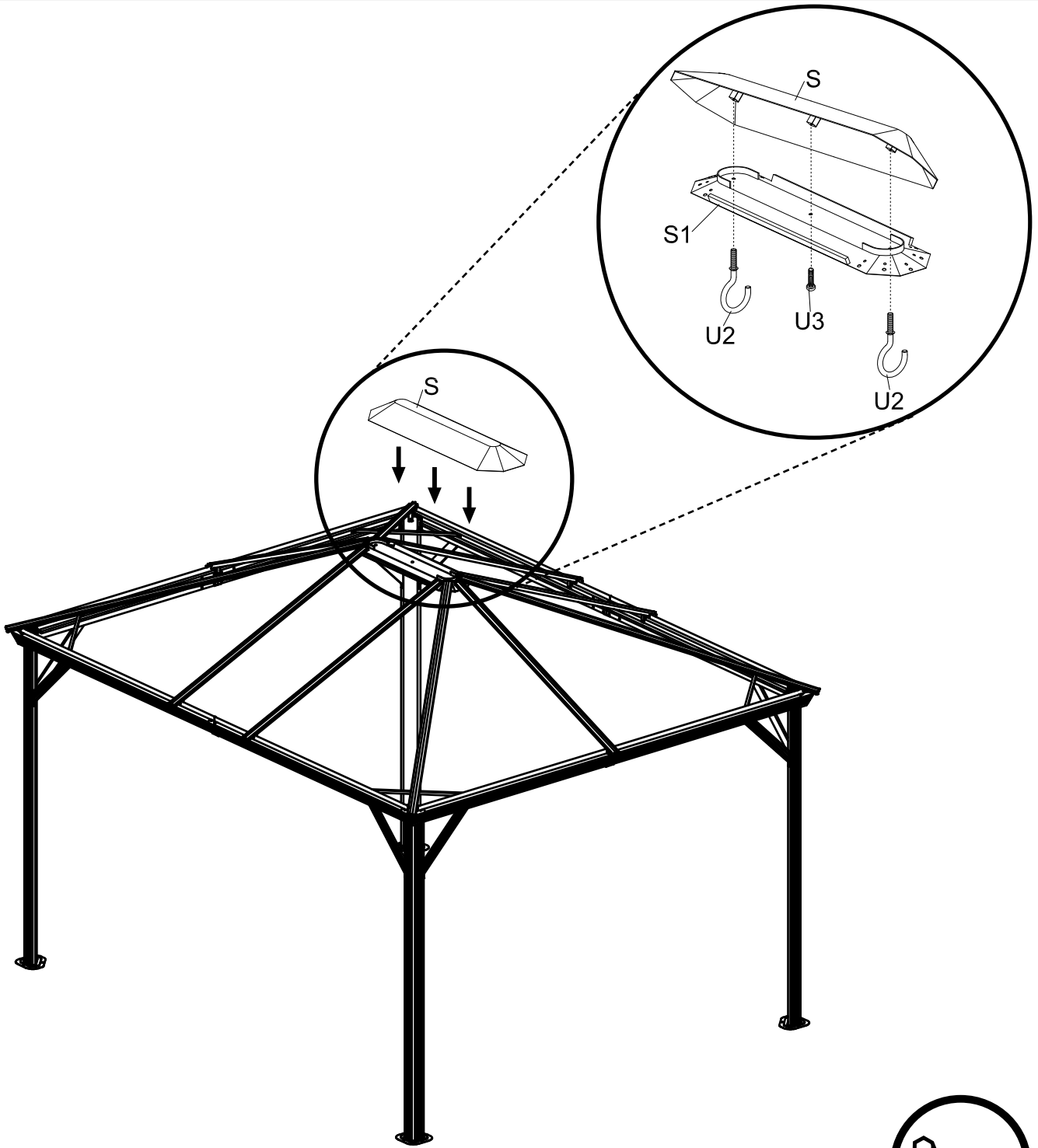

Sx1



U2x2

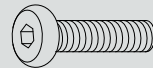

U3x1

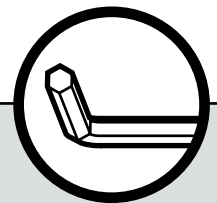
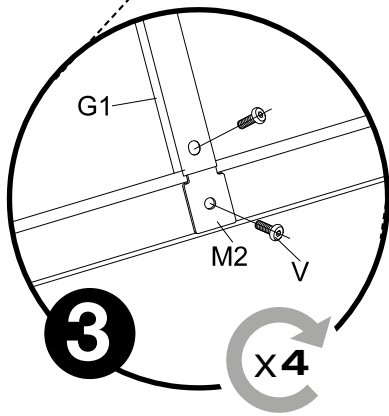
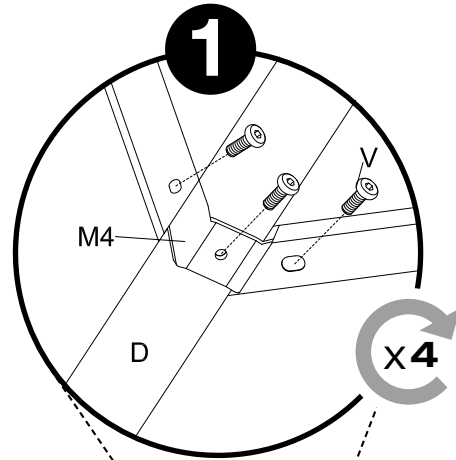
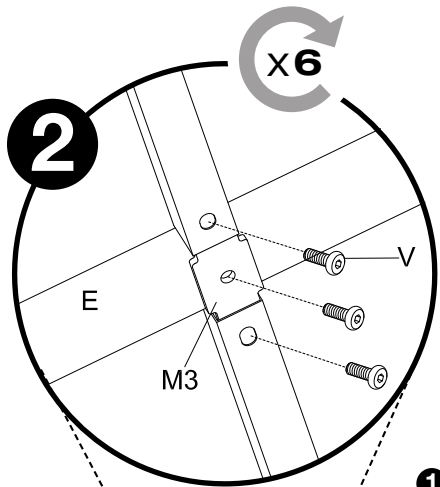
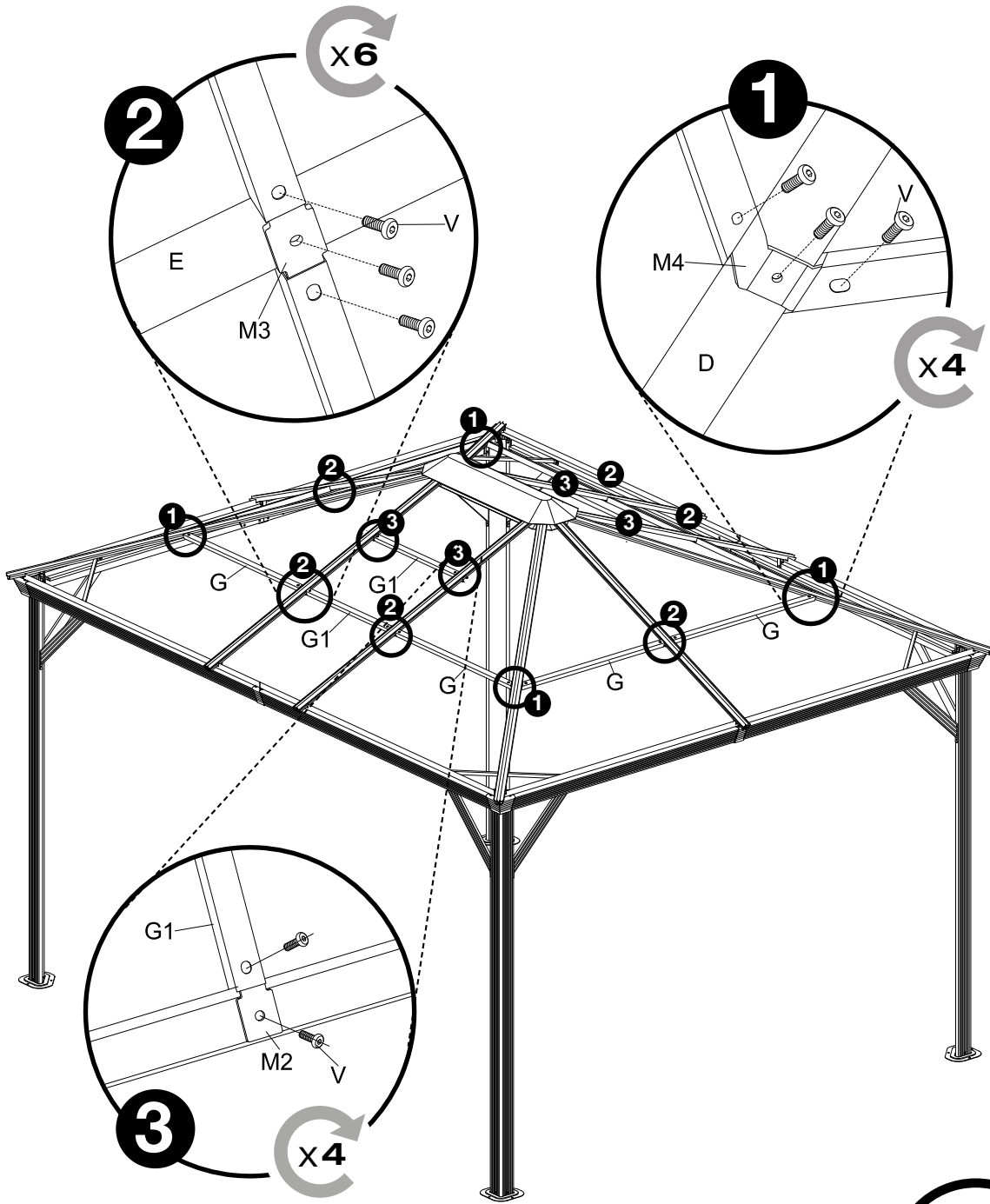

Gx8



G1x4

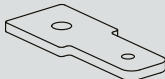

M2x4



M3x6

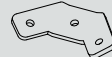

M4x4

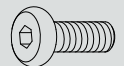

Vx38

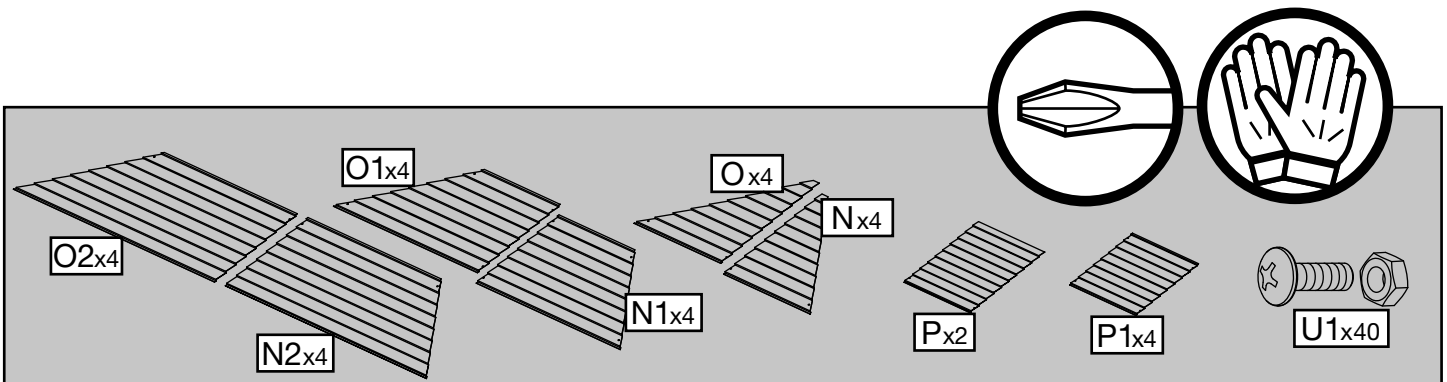
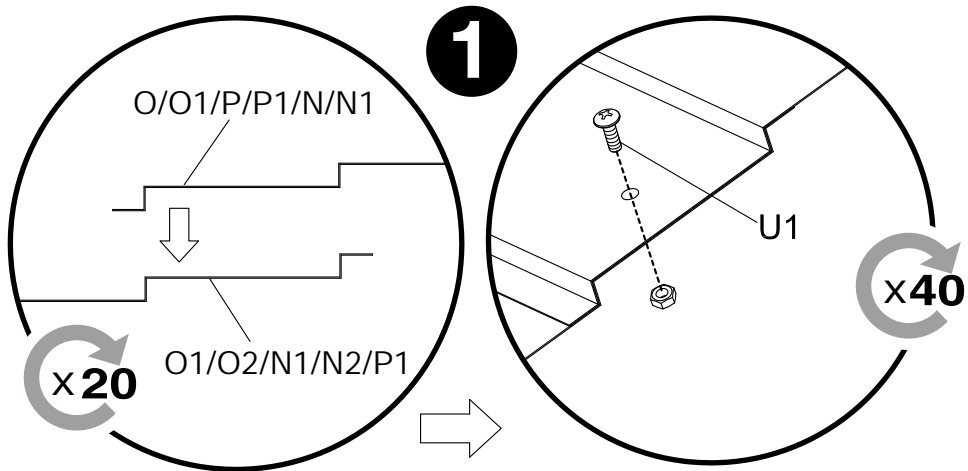
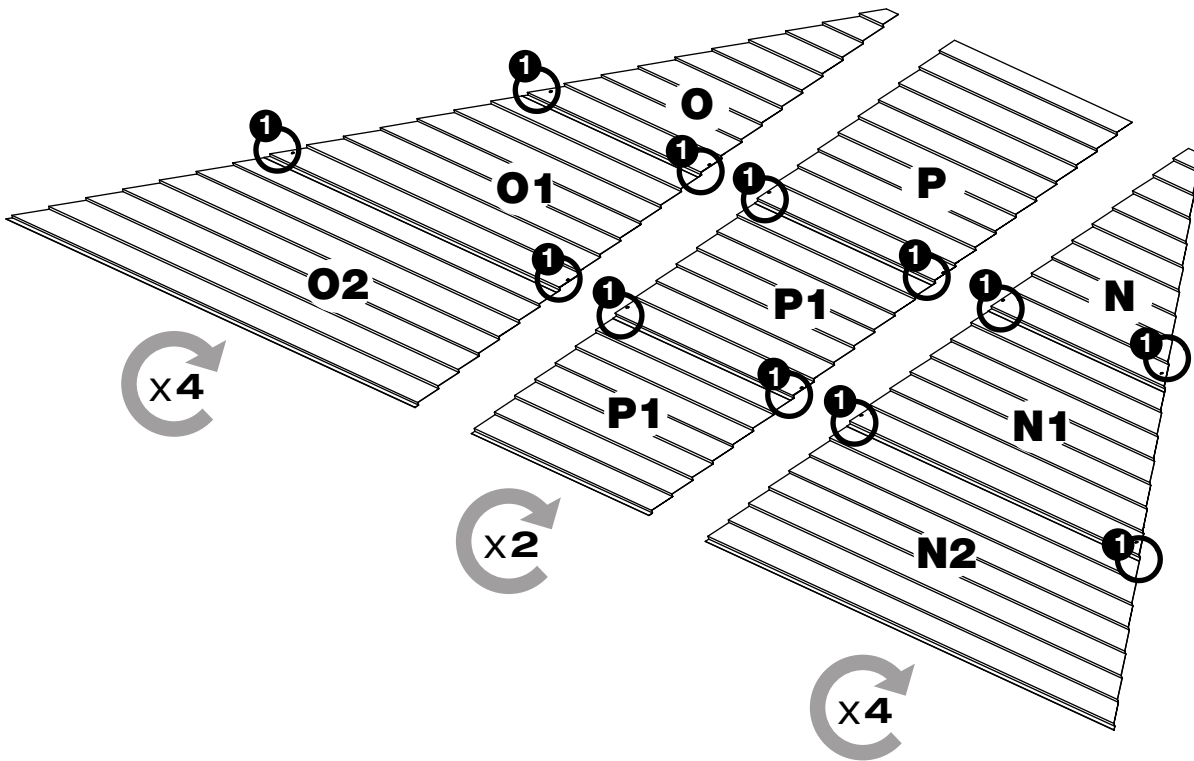

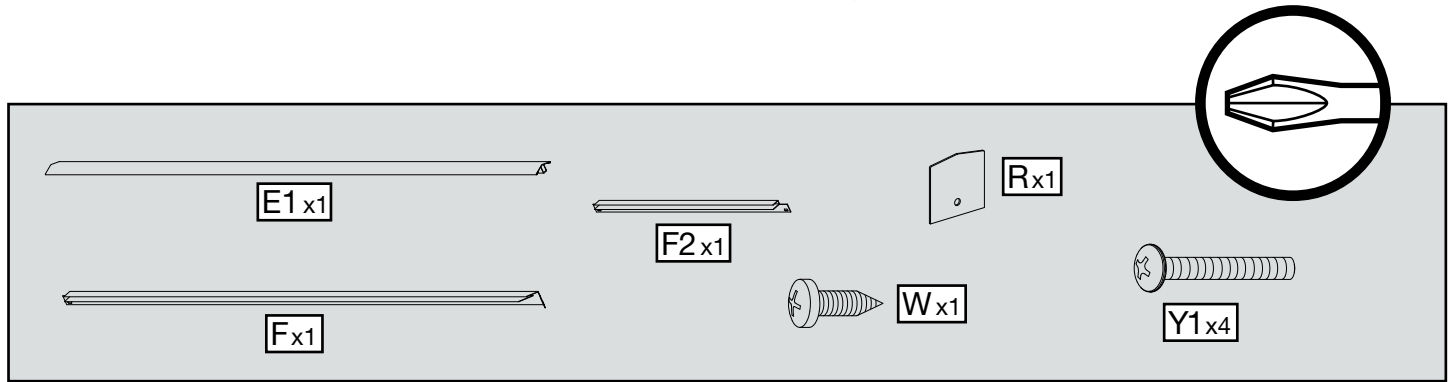
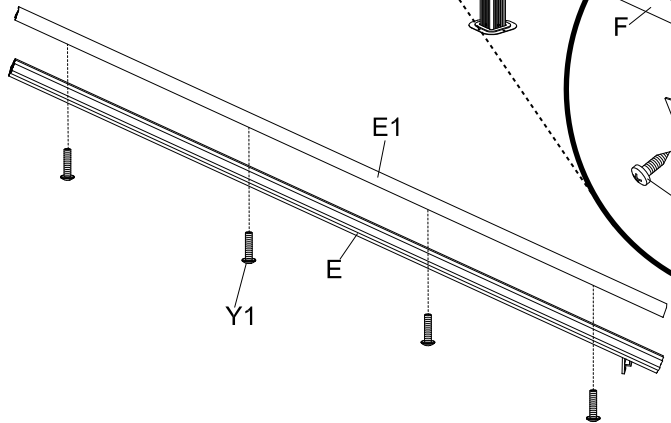
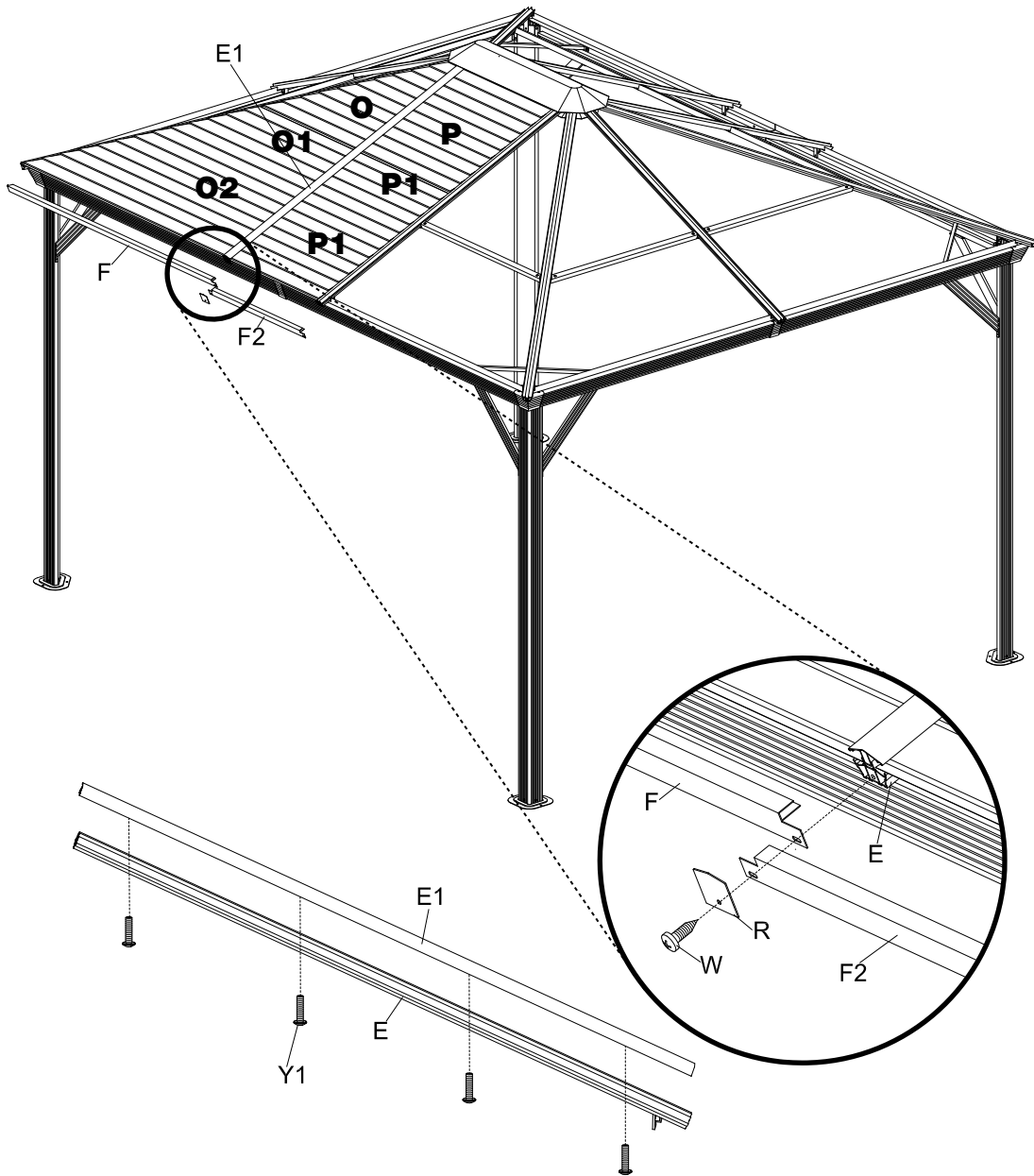

Register • Enregistrer • Regístrate
온라인 등록 • Registrieren

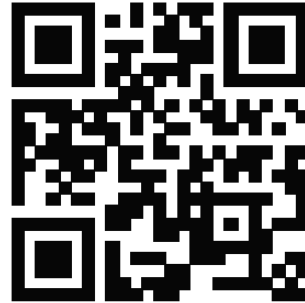
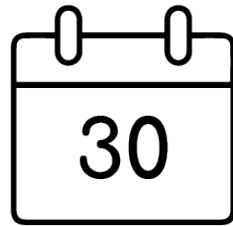

ShelterLogic.com/product-registration

50NRTH GmbH
Straßburgstraße 14-16
Germany 54516 Wittlich
phone +49 (0) 6571 / 95 117- 0
Fax +49 (0) 6571 / 95 117- 98
[www. 50NRTH.com](http://www.50NRTH.com)
info@50NRTH.com



SOJAG ■ I