

SOJAG

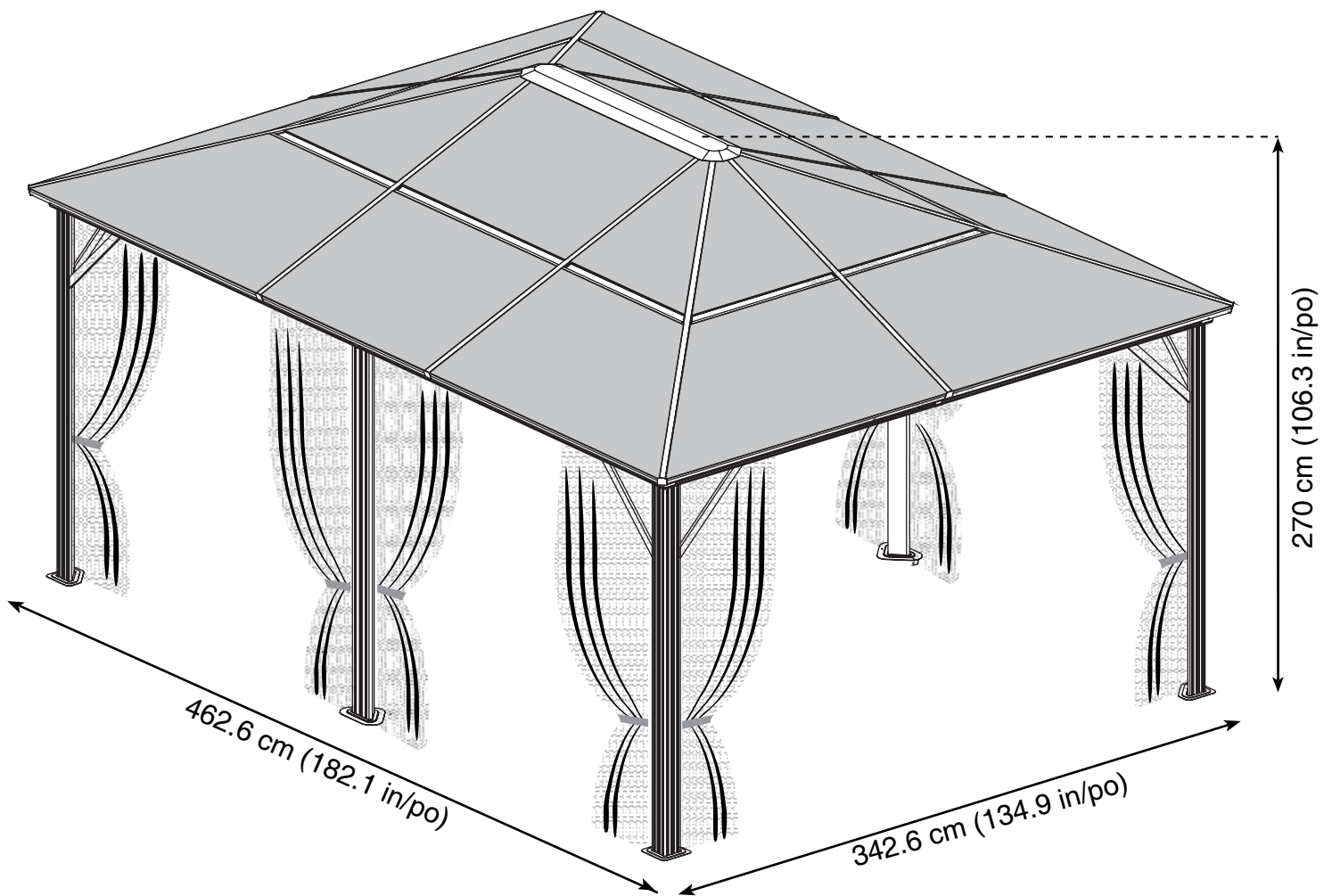

QUESTIONS? +49 (0) 6571 / 95117-0

Assembly Manual / Guide d'assemblage / Manual de ensamblaje / 조립설명서 / Montageanleitung



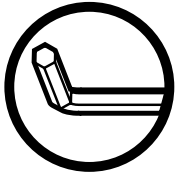

Use the hex keys in the box. / Utilisez les clés hexagonales fournies dans la boîte. / Utilice las llaves hexagonales en la caja. / 상자에 육각 키를 사용 하십시오. / Verwenden Sie die Sechskantschlüssel in der Box.

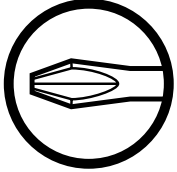

Please use a Phillips screwdriver. / Utilisez un tournevis de type Phillips / Por favor, use un destornillador Phillips. / 십자 드라이버를 사용 하십시오. / Bitte verwenden Sie einen Kreuzschraubenzieher.



You may need to use a drill for this step. / Vous pouvez avoir besoin d'utiliser une perceuse pour cette étape. / Puede que tenga que utilizar un taladro para este paso. / 이 단계에선 드릴을 사용해야 할 수도 있습니다. / Für diesen Schritt können Sie einen Bohrer verwenden.



Wearing protective gloves is recommended. / Le port de gants de protection est recommandé / El uso de guantes de protección se recomienda. / 보호 장갑을 착용 하는 것이 좋습니다. / Das Tragen von Schutzhandschuhen wird empfohlen.



Two or more people are required at this stage. / Deux personnes ou plus sont nécessaires à cette étape. / Dos o más personas se requieren en esta etapa. / 이 단계에서는 두 명 이상이 필요합니다. / Für diesen Bauschritt sind 2 oder mehr Personen erforderlich.



Do not tighten screws all the way for now. / Ne pas visser fermement pour l'instant. / No atornille con firmeza por ahora. / 아직 나사를 단단히 조이지 마십시오. / Bitte die Schrauben zum jetzigen Zeitpunkt noch nicht fest anziehen.



Sold separately. / Vendus séparément. / vendido en las opciones. / 옵션 판매 / Optional erhältlich

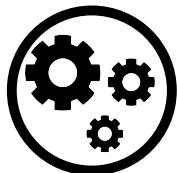

Optional step / Étape optionnelle / Paso opcional / 선택적 단계 / Optionaler Schritt

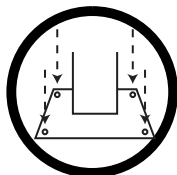

The gazebo must be anchored (hardware not included) / Le gazébo doit être ancré (quincaillerie non incluse) / El gazebo debe estar anclado (herramientas no incluidas) / gaze보를 반드시 바닥에 고정 시키세요. (고정 나사 부품 미포함) / Muss am Boden verankert werden, Befestigungsmaterial nicht im Lieferumfang enthalten

U X 68(+6)

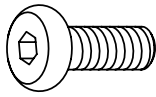

U1 X 52 (+5)

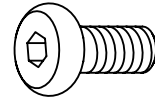

U2 X 2 (+1)



V X 16 (+3)

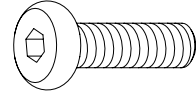

V1 X 1 (+1)

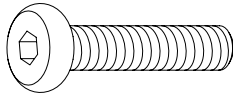

W X 16 (+2)

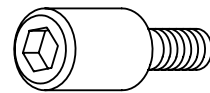

X X 10 (+2)

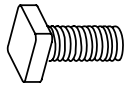

X1 X 30 (+6)



Y X 24 (+4)

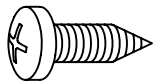

Y1 X 20 (+4)

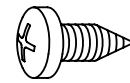

Z X 1

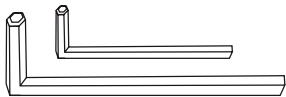

Z1 X 2

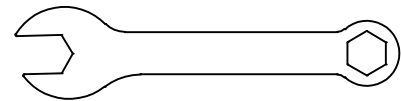



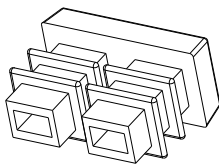





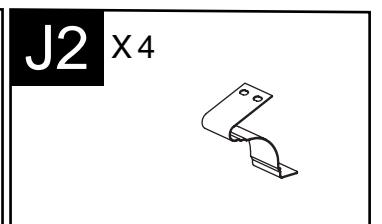
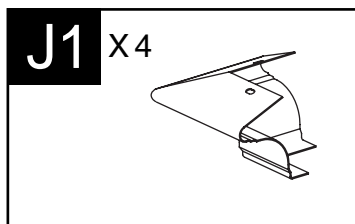
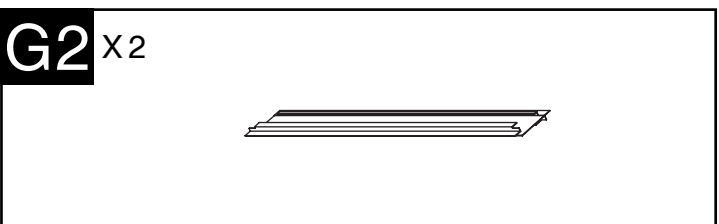
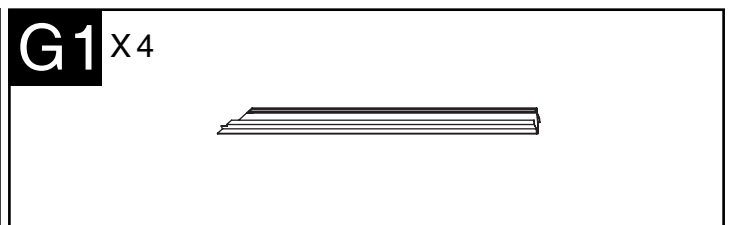
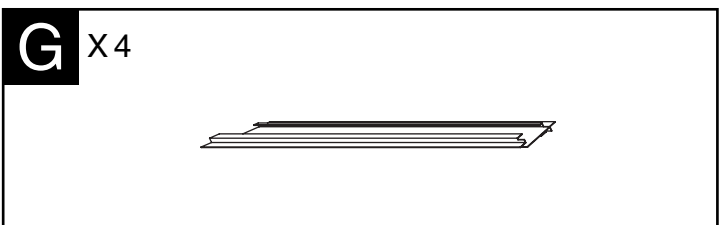
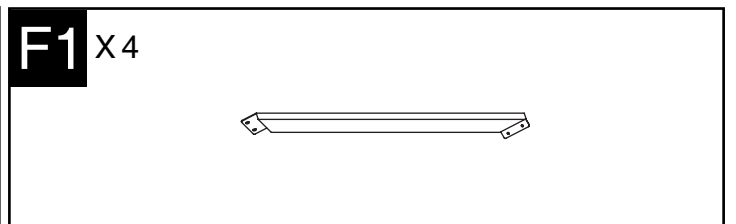
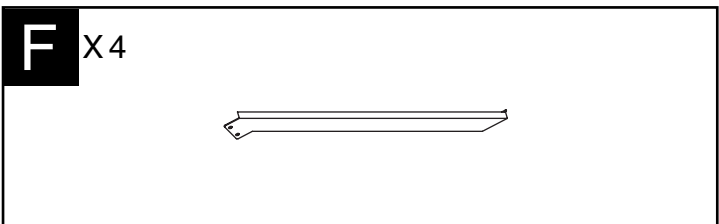
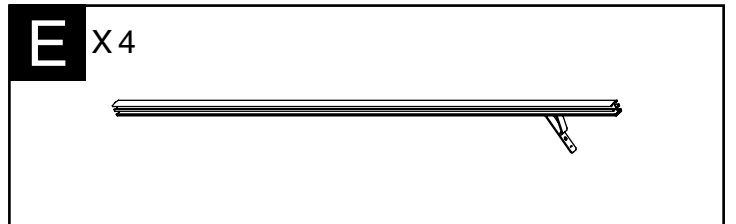
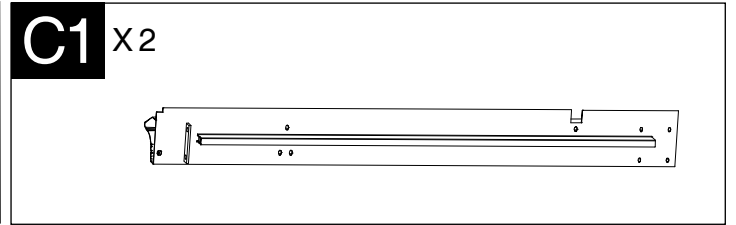
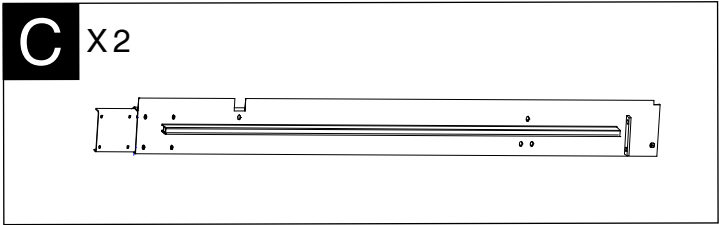
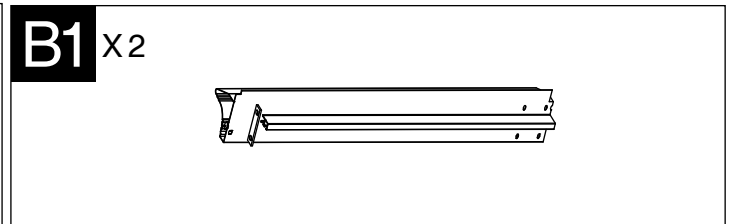
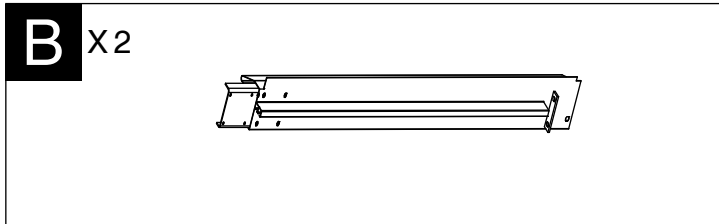
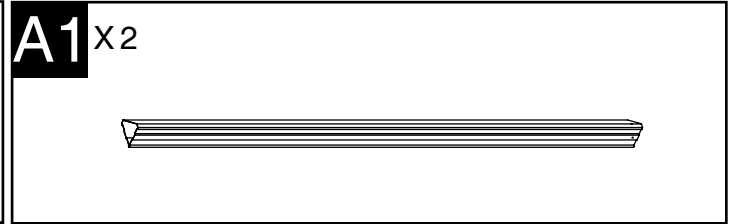
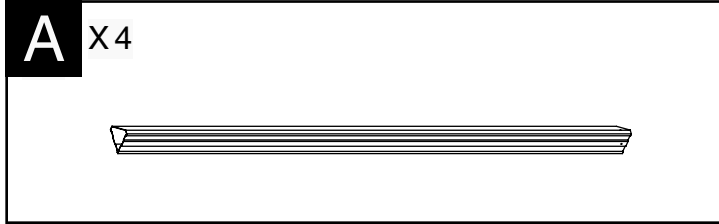







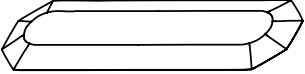
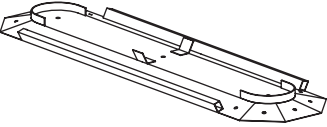
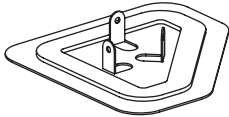
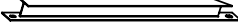
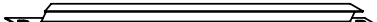
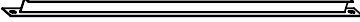

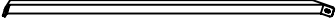
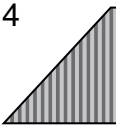
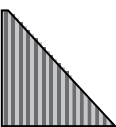
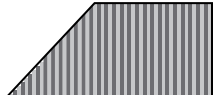
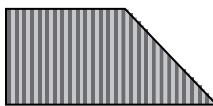
Z2 X 4(+1)

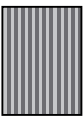

Z3 X 8(+2)

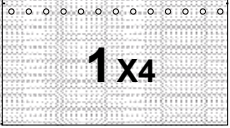
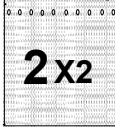



H X4 	H1 X4 	H2 X2 
I X4 	I1 X4 	I2 X2 
K X1 	K1 X1 	L X6 
N X4 	N1 X4 	
N2 X2 	O X4 	O1 X6 
Q X4 	Ma X4 	M1a X4 
Mb X4 	M1b X4 	
P X2 	P1 X2 	T X68 (+2) 
		T X68 (+2) Optional  
Net  1 X4  2 X2	Curtain  3 X4  4 X2	Optional 

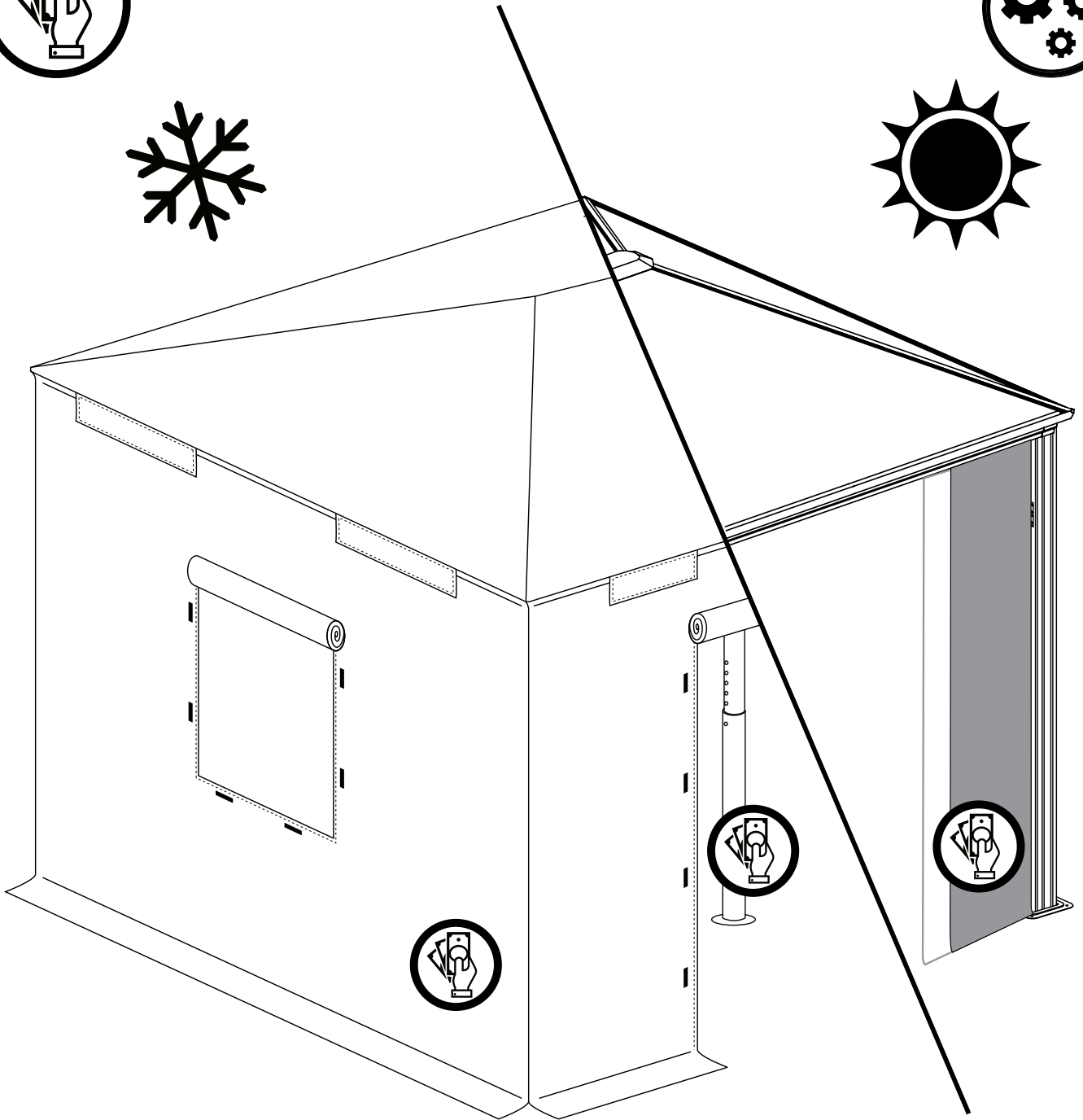
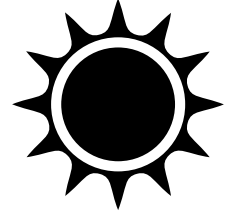
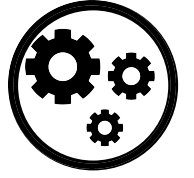
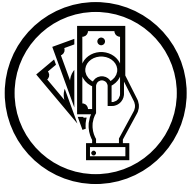

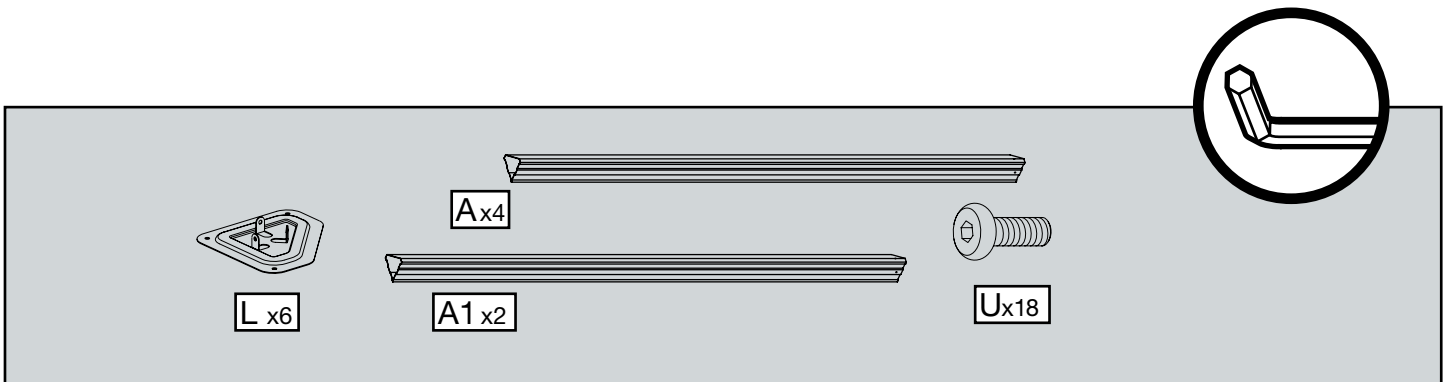
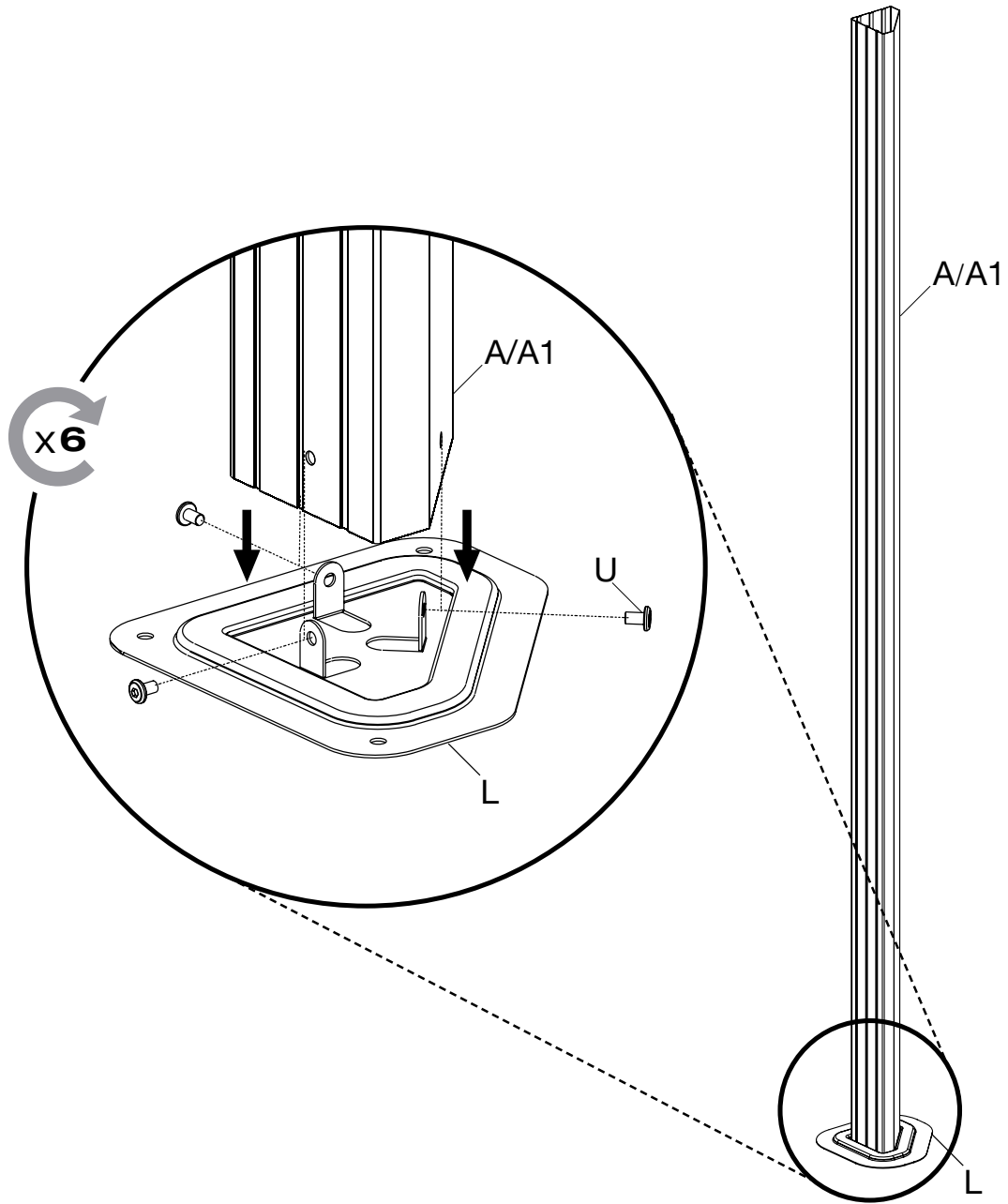

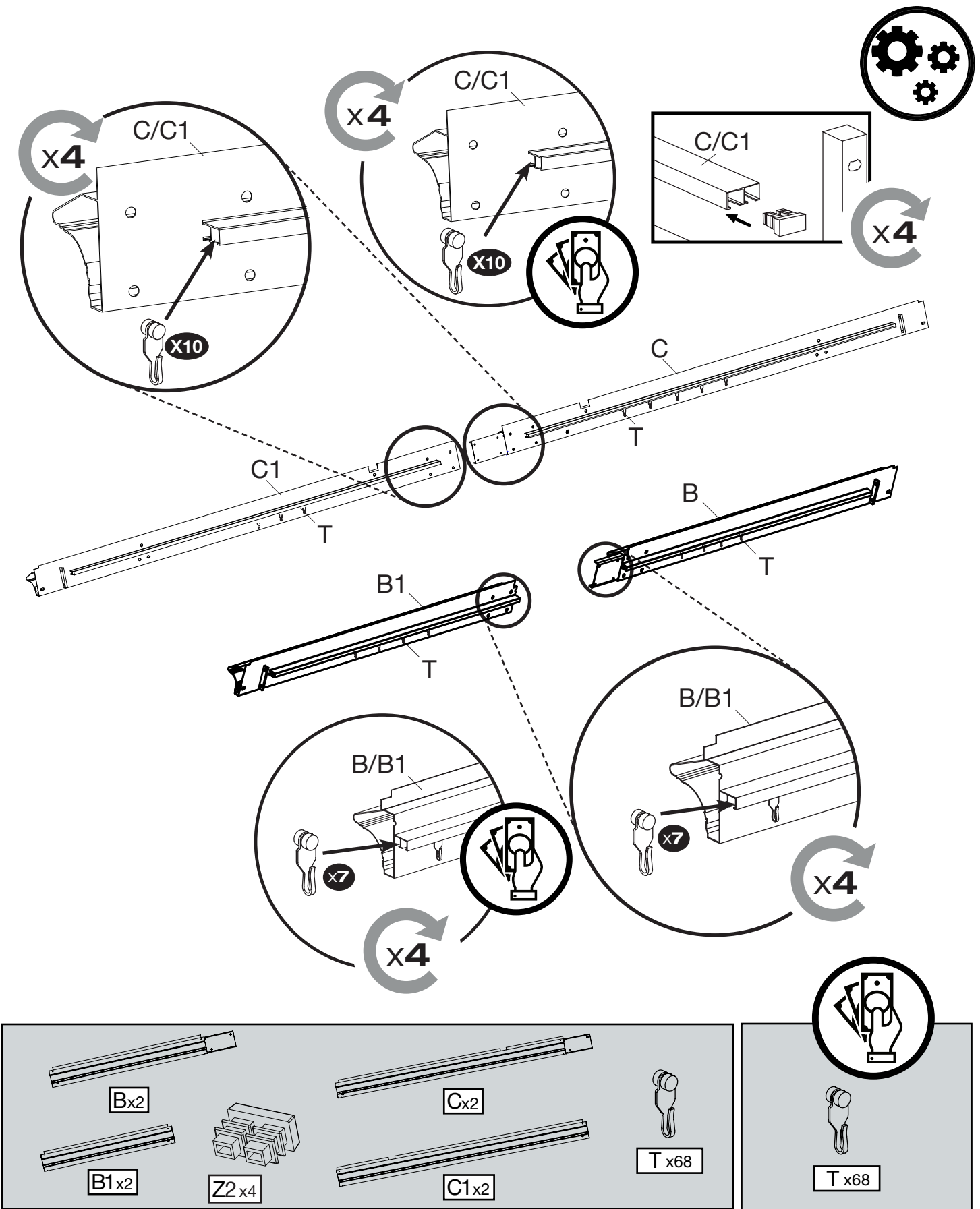

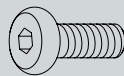
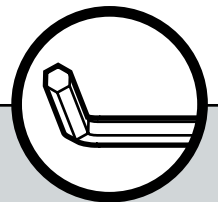
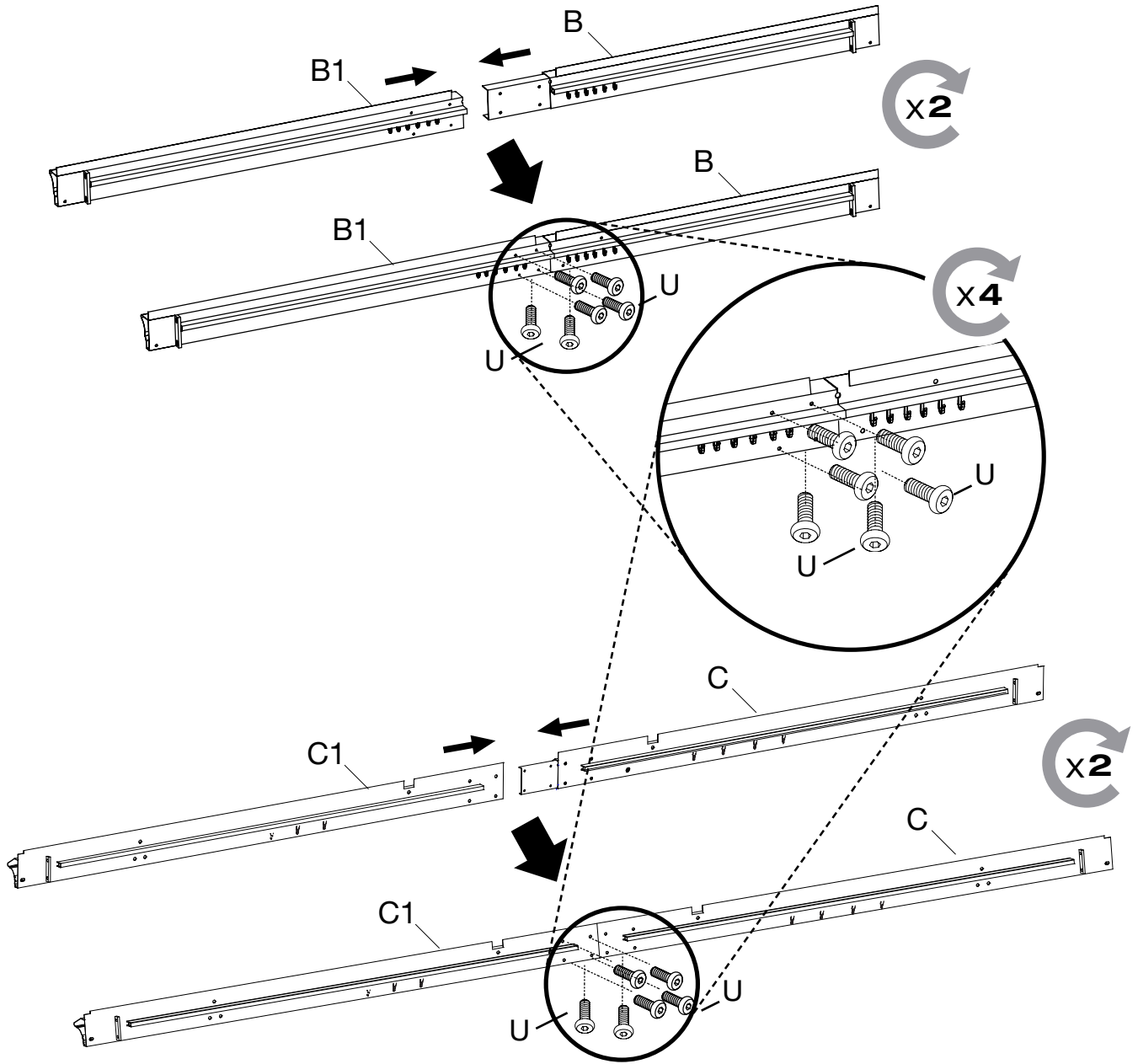

Ux24

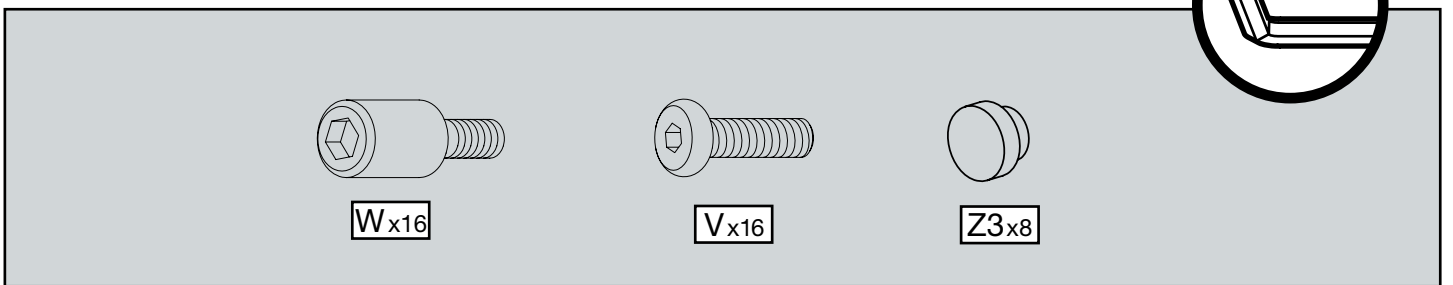
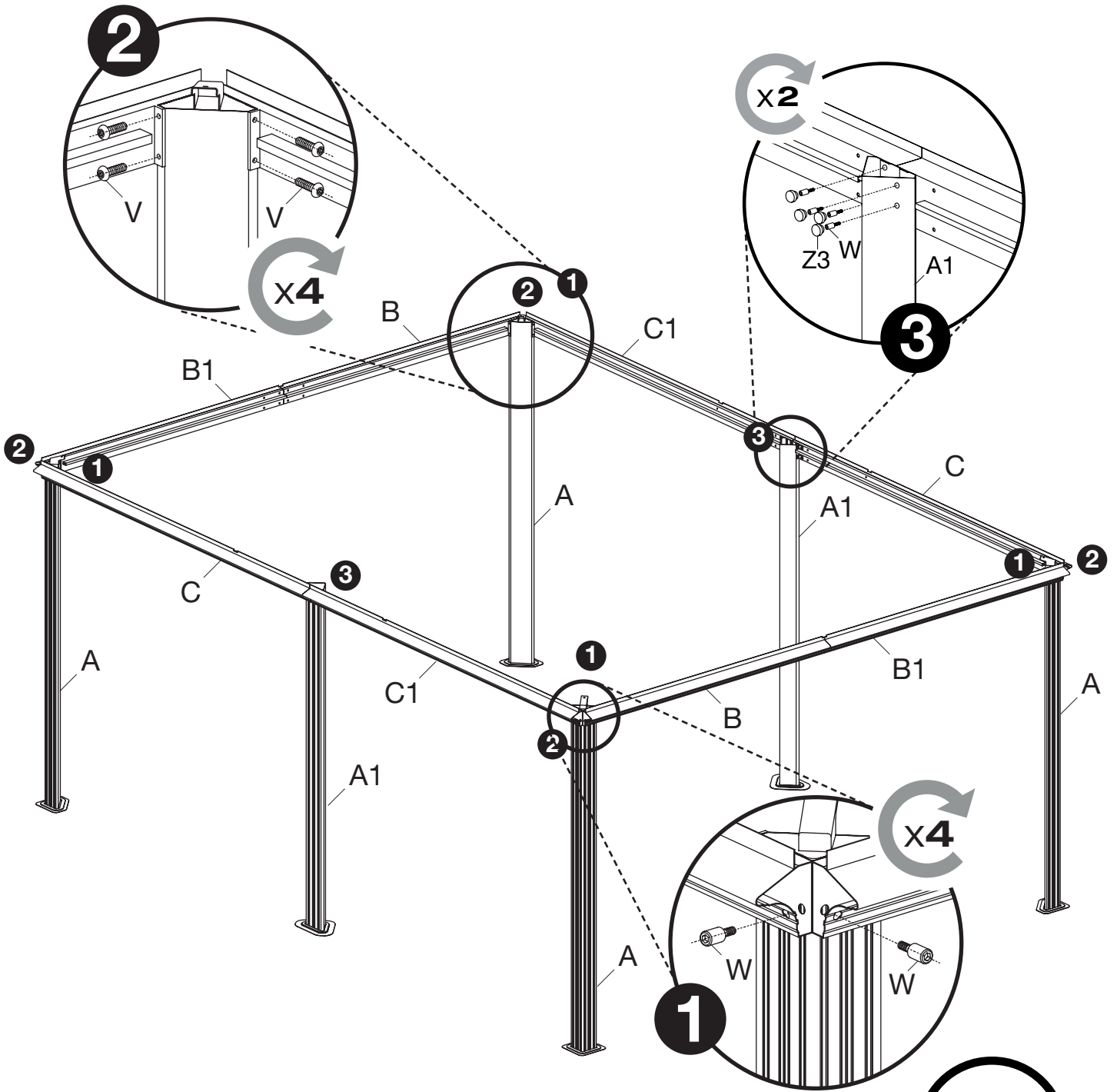

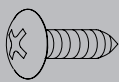
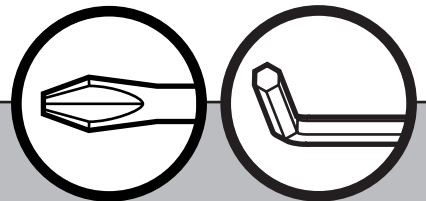
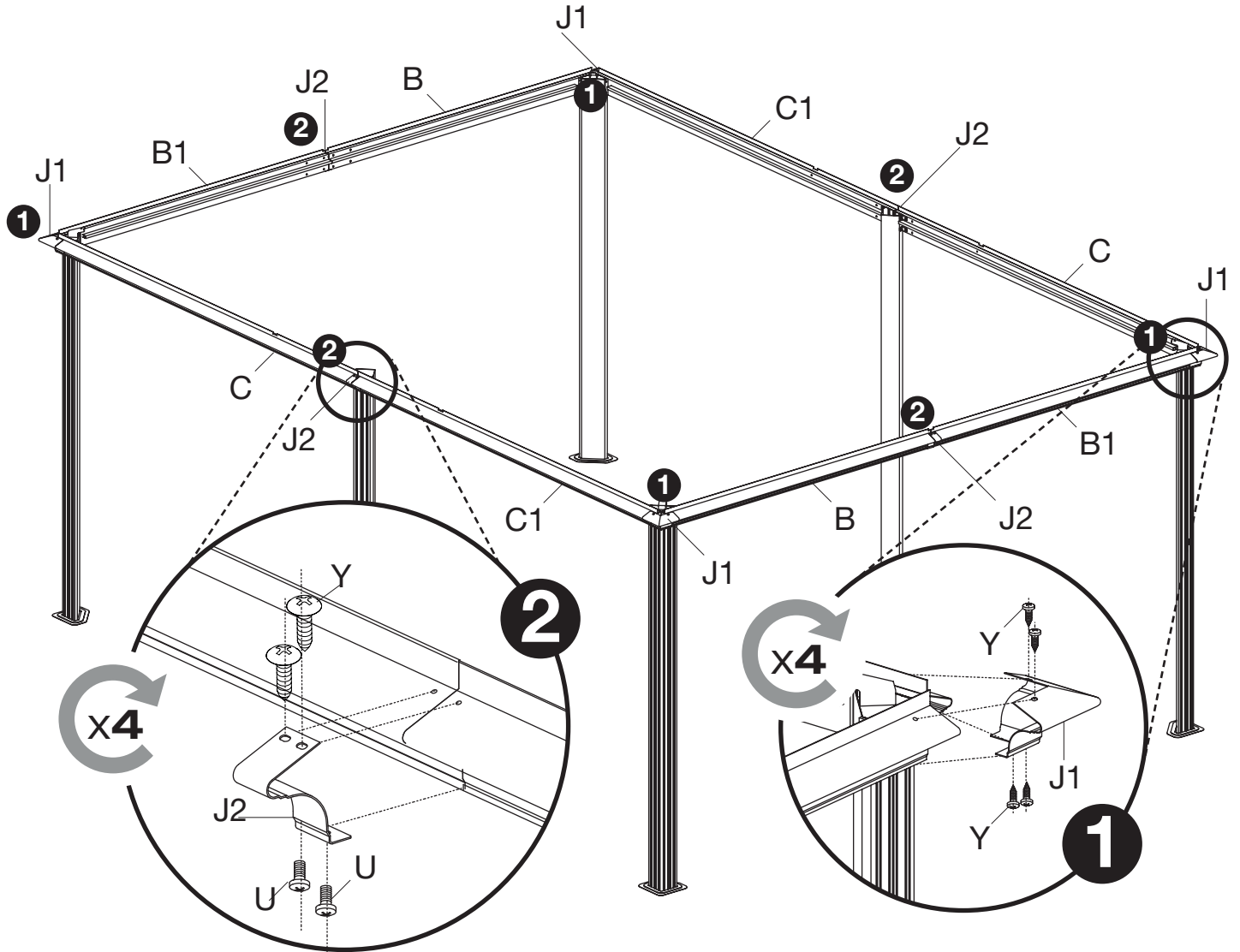

Y x24

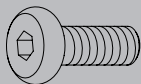

Ux8

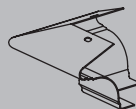

J1 x4

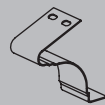

J2 x4

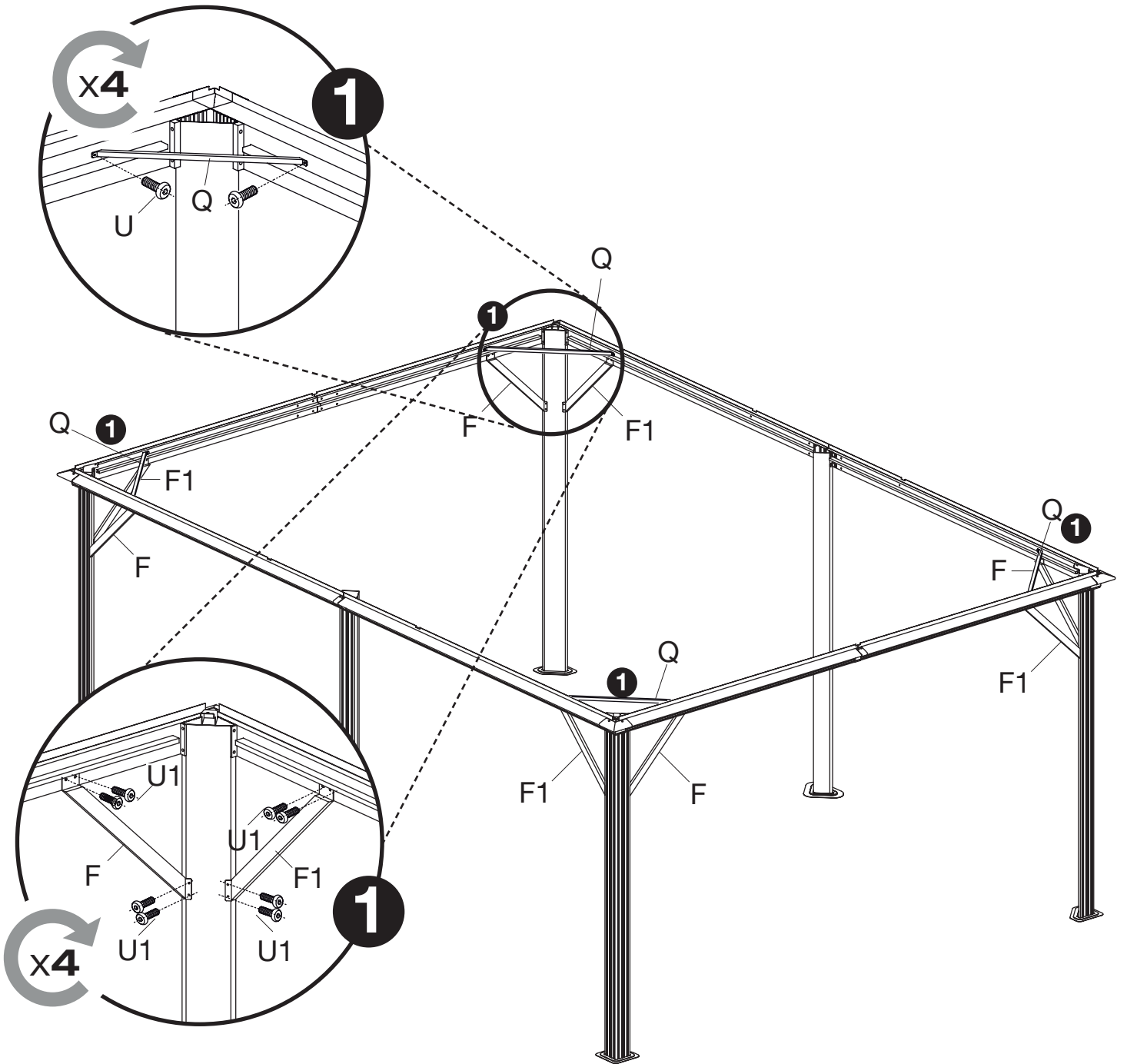

This section lists the parts required for the assembly. It includes two types of top rails (labeled F_{x4} and $F1_{x4}$), four diagonal cross-braces (labeled Q_{x4}), eight bolts (labeled U_{x8}), and 32 bolts (labeled $U1_{x32}$). A circular icon on the right shows a corner joint with a bolt and nut.

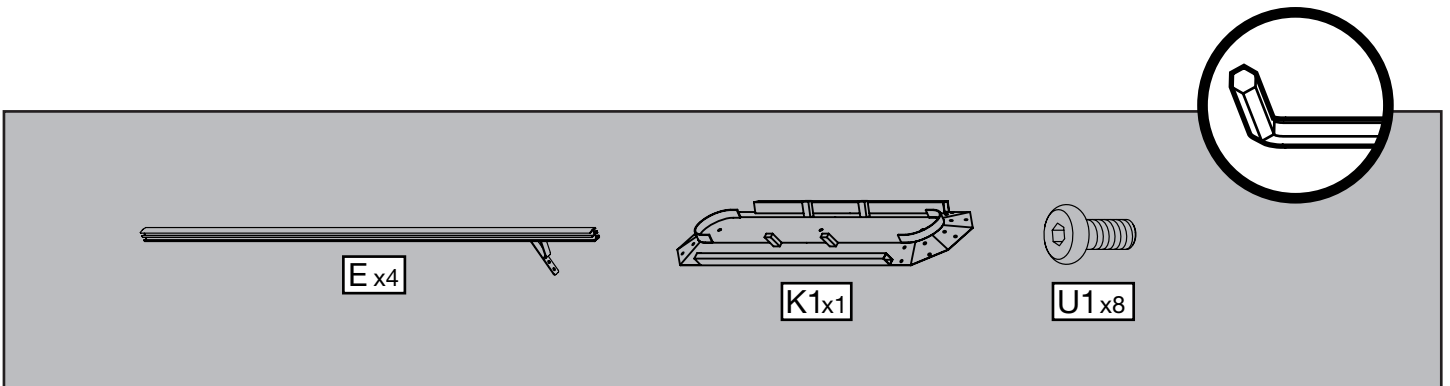
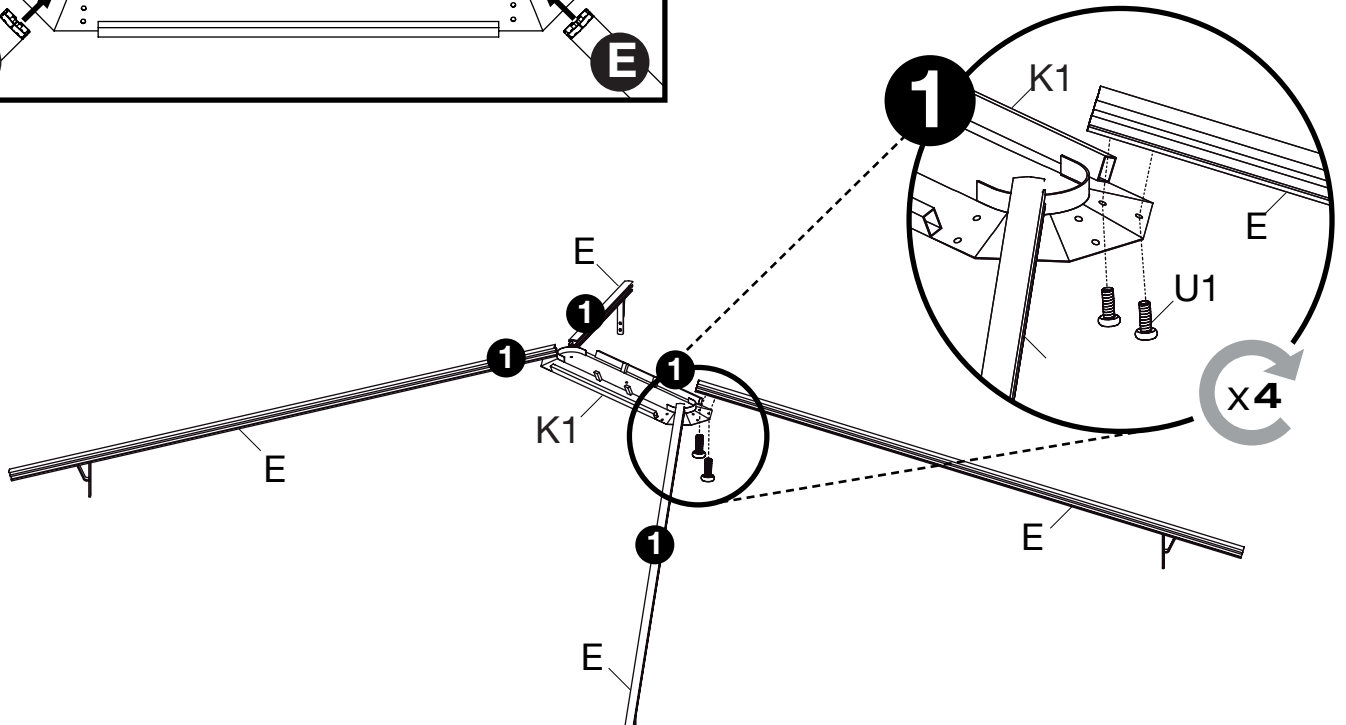
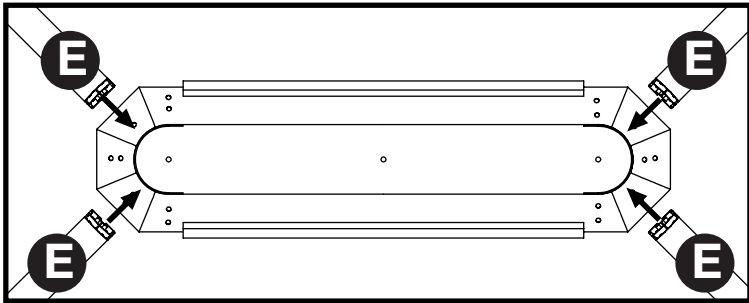

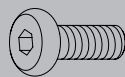
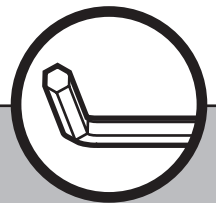
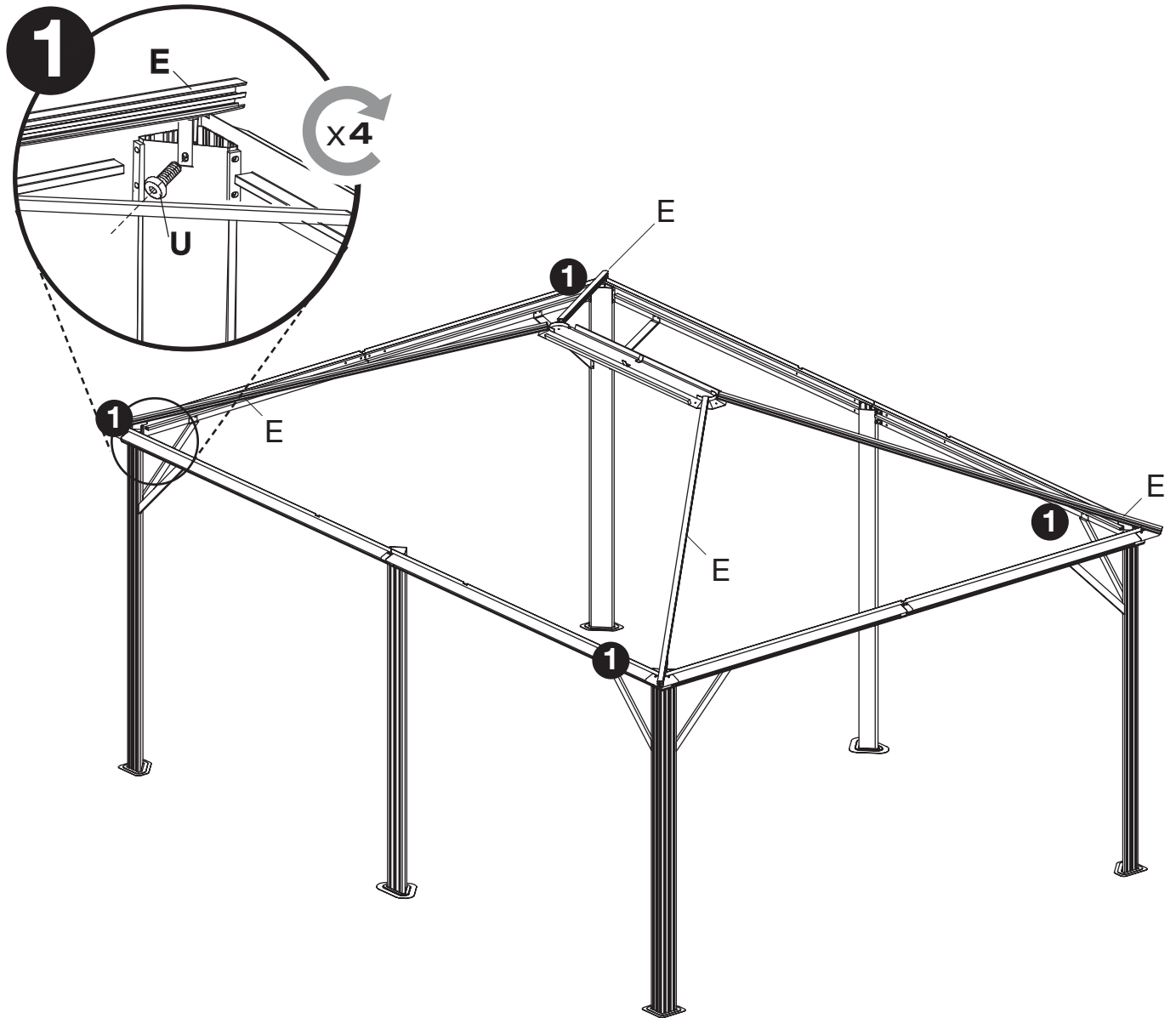

Ux4

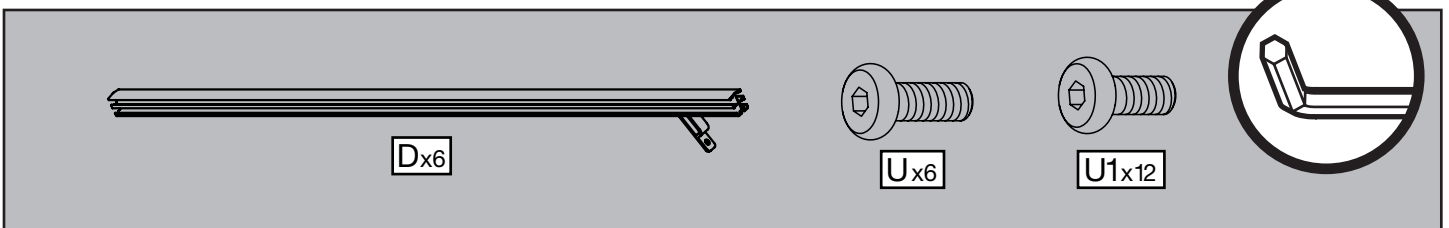
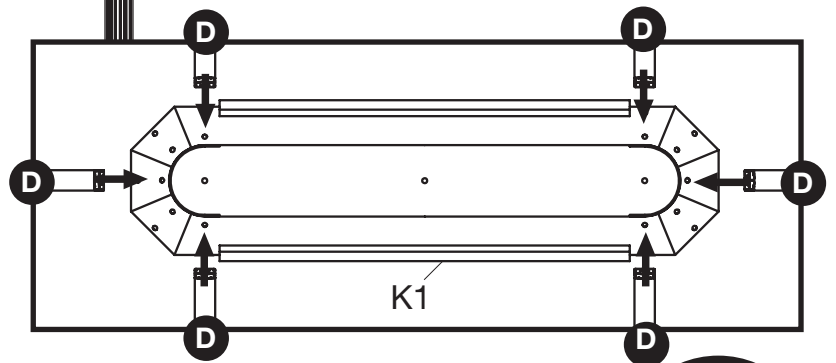
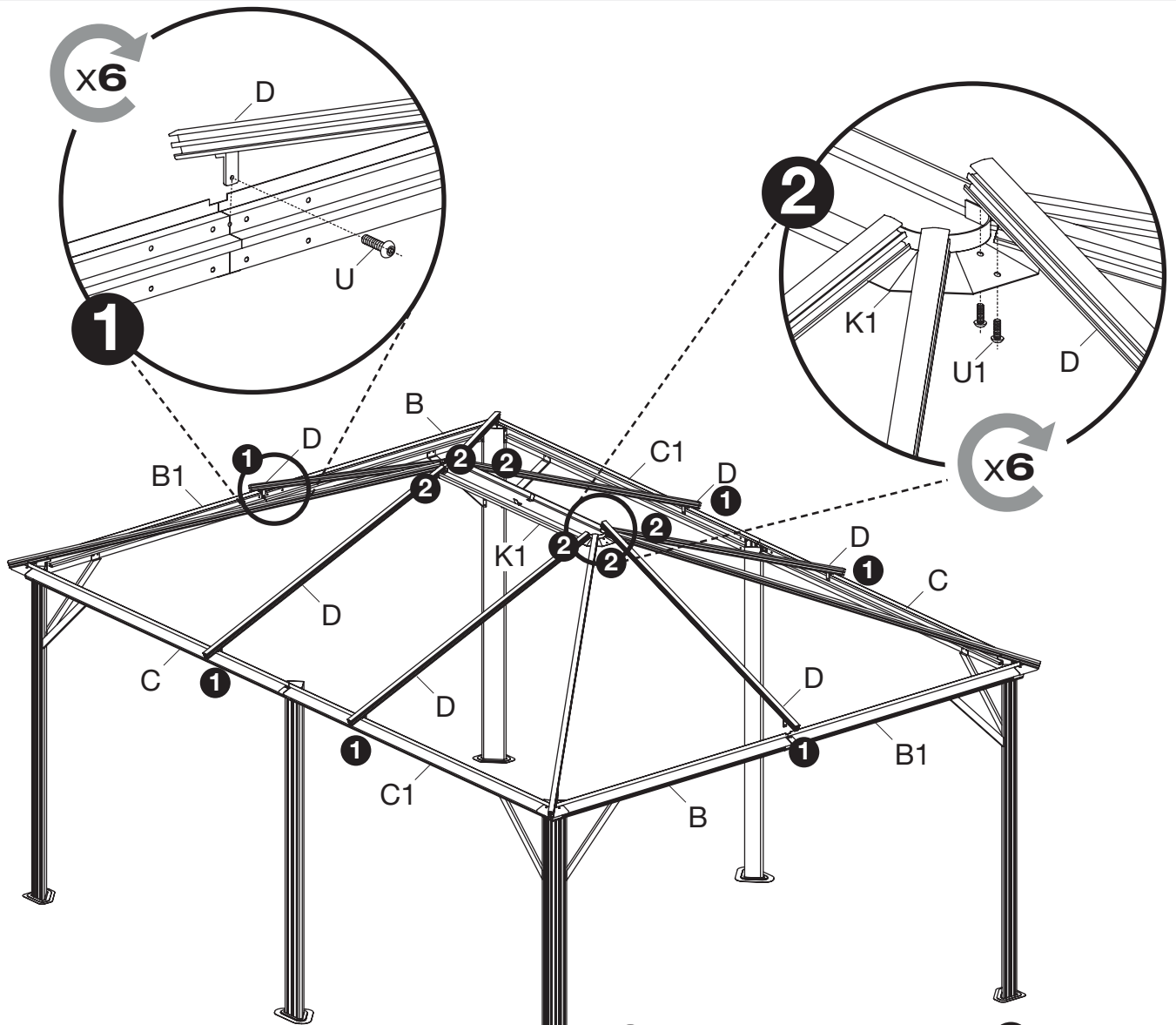

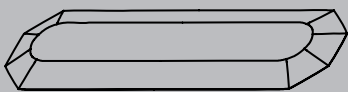
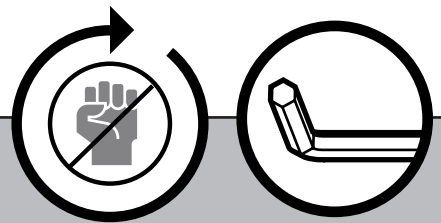
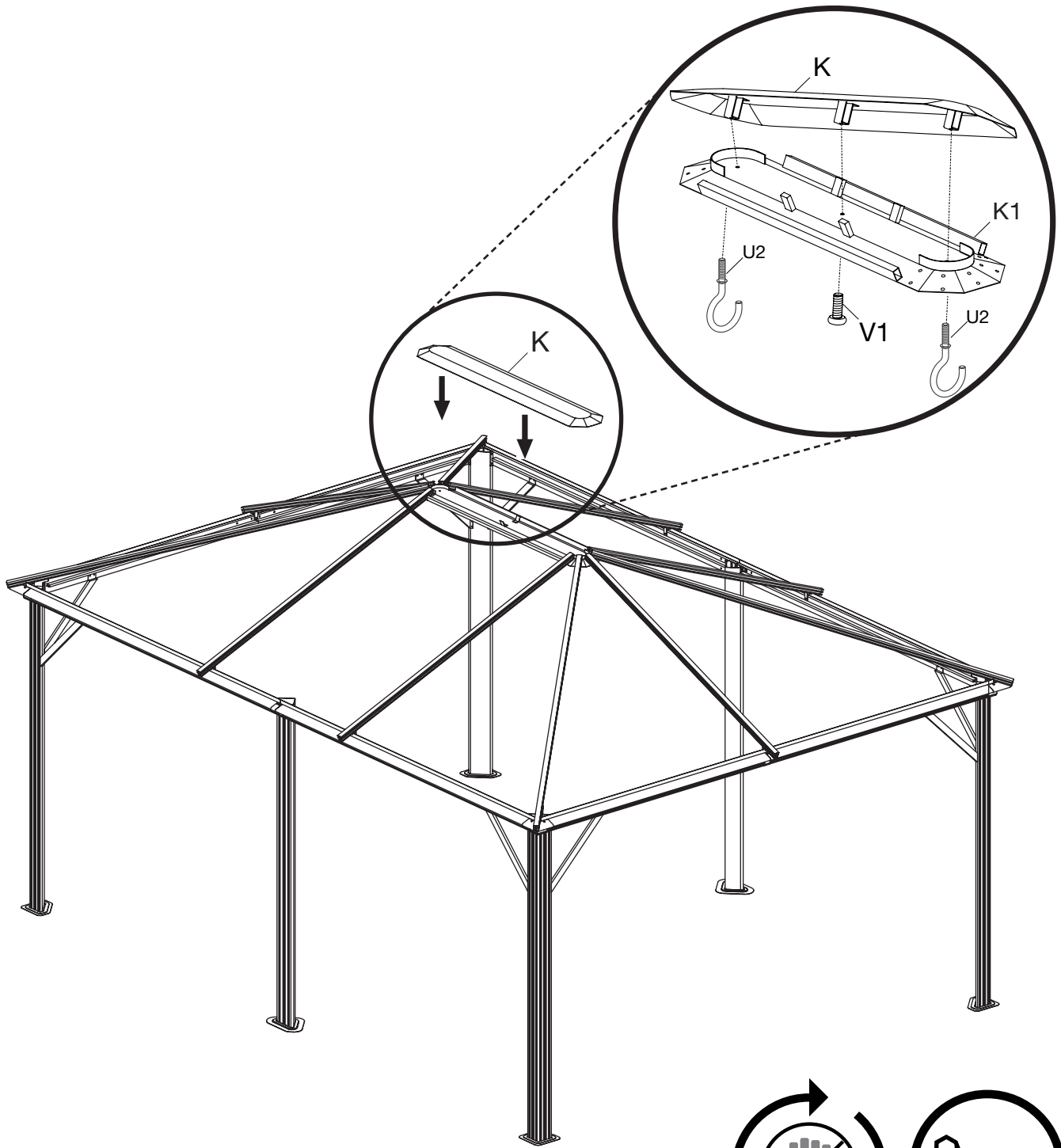

Kx1

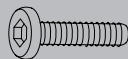

V1x1



U2 x2

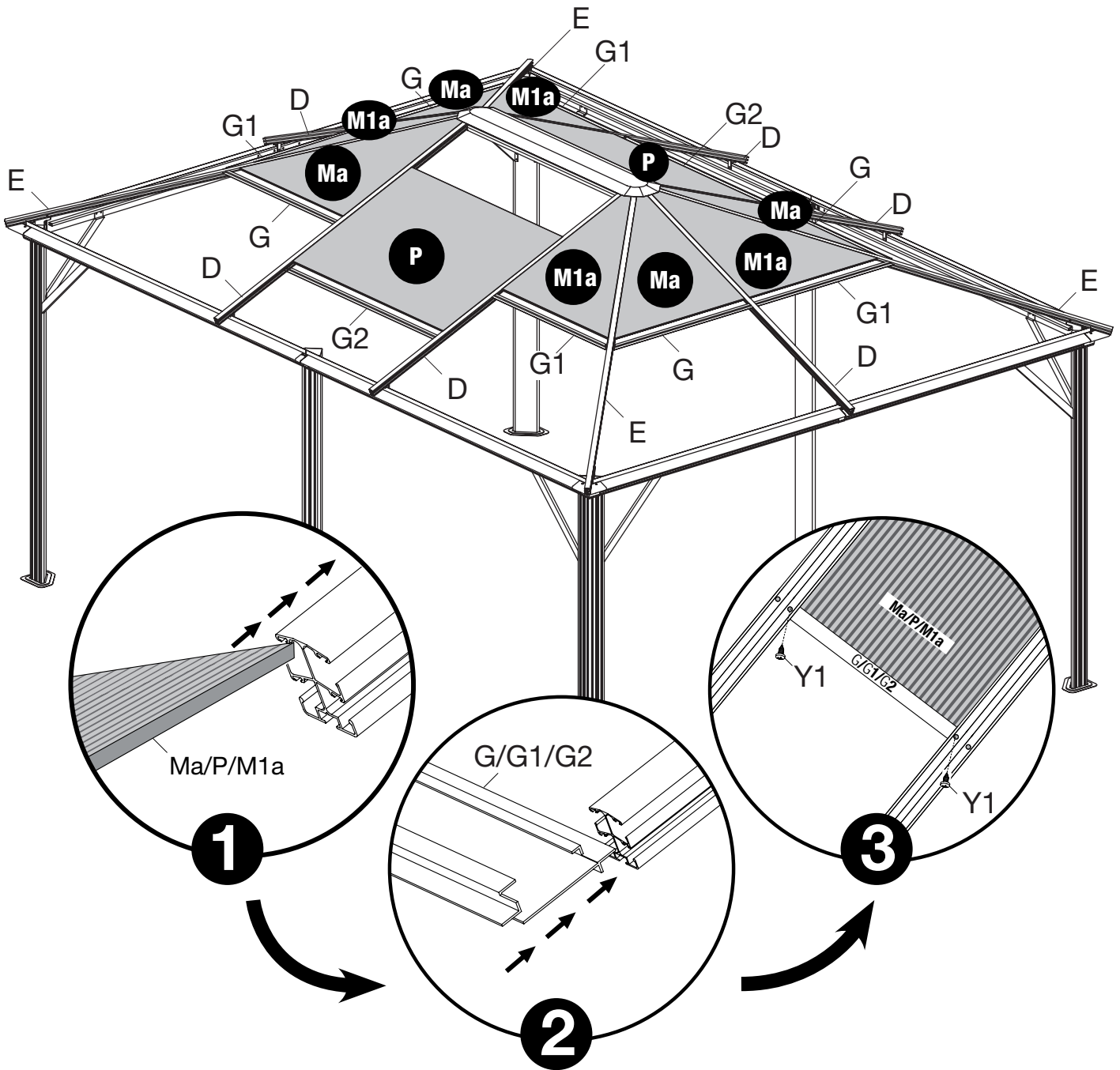

A parts list and safety icon are located at the bottom of the page. The parts list includes:

- Ma x4 (four triangular panels)
- P x2 (two rectangular panels)
- M1a x4 (four trapezoidal panels)
- Y1 x20 (twenty screws)
- G x4 (four horizontal beams)
- G1 x4 (four horizontal beams)
- G2 x2 (two horizontal beams)

A safety icon of a pair of hands is also present.

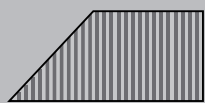
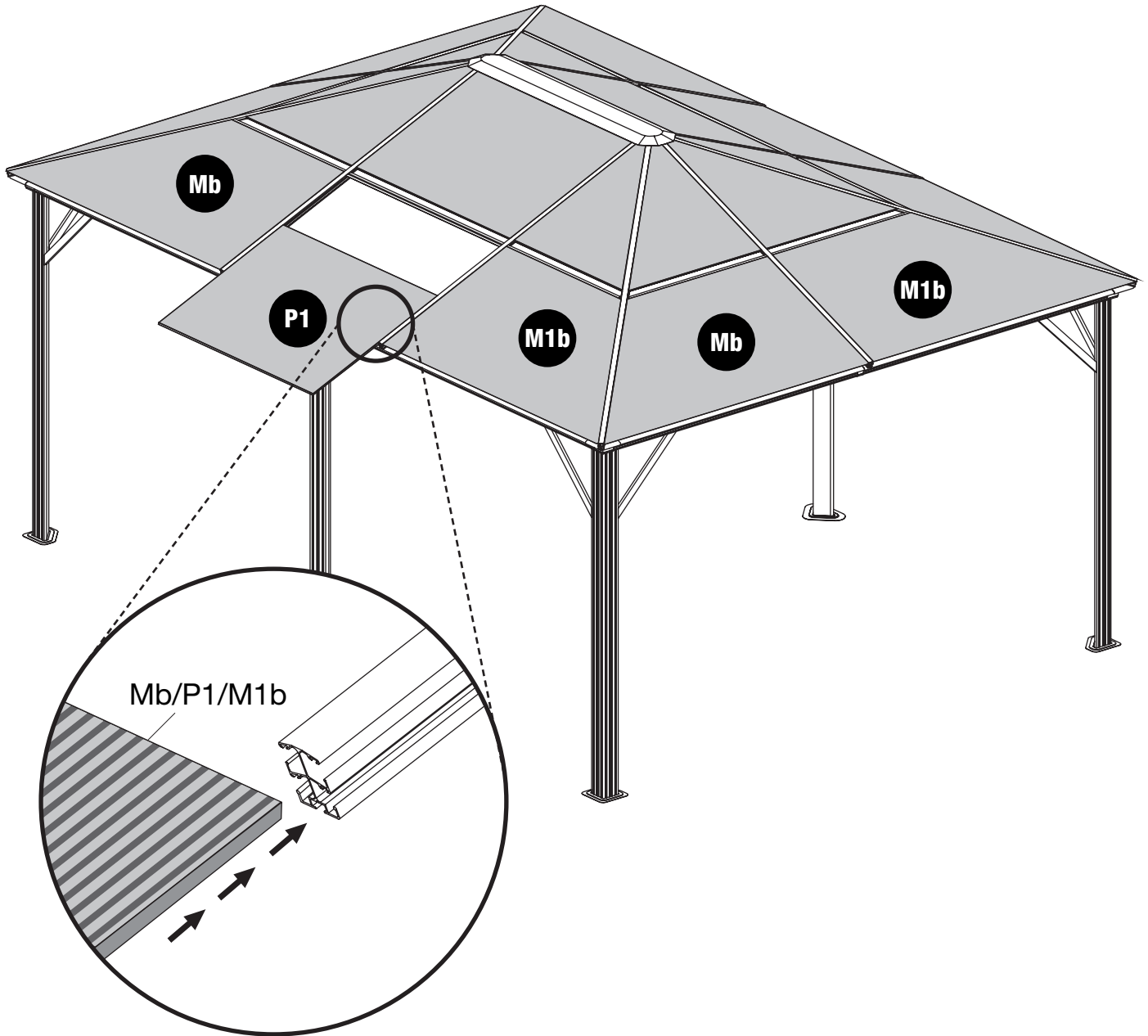

Mb x 4

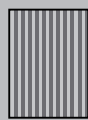

P1 x 2

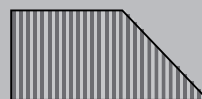

M1b x 4

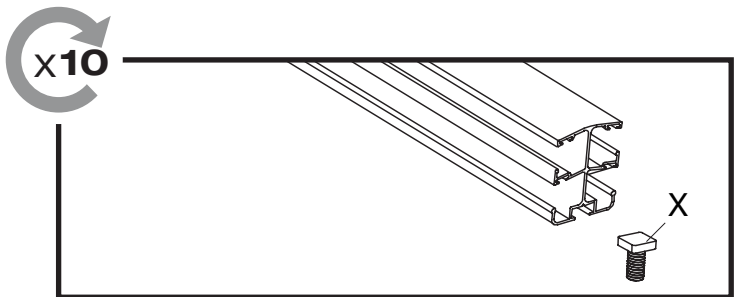
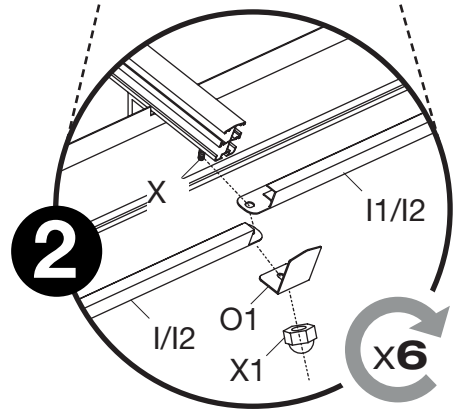
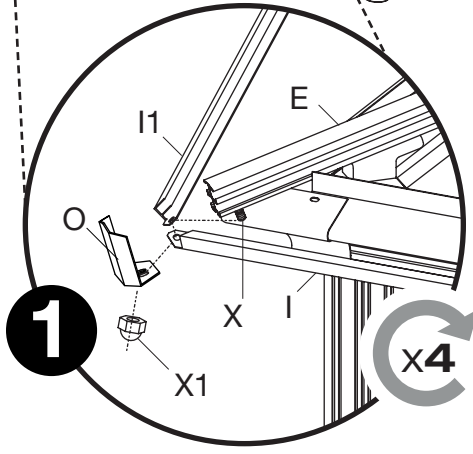
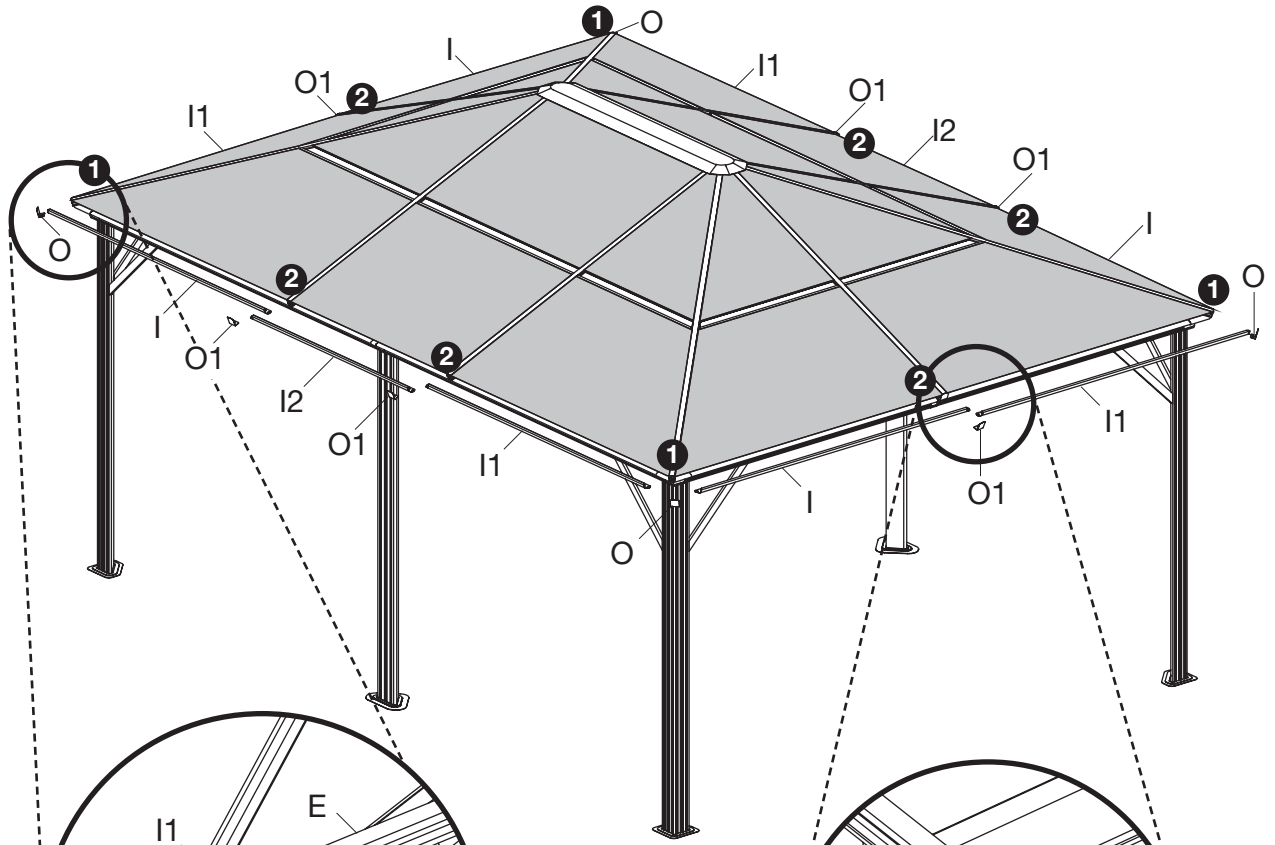





I x4



I2 x2



I1 x4



O x4



O1 x6









X x10

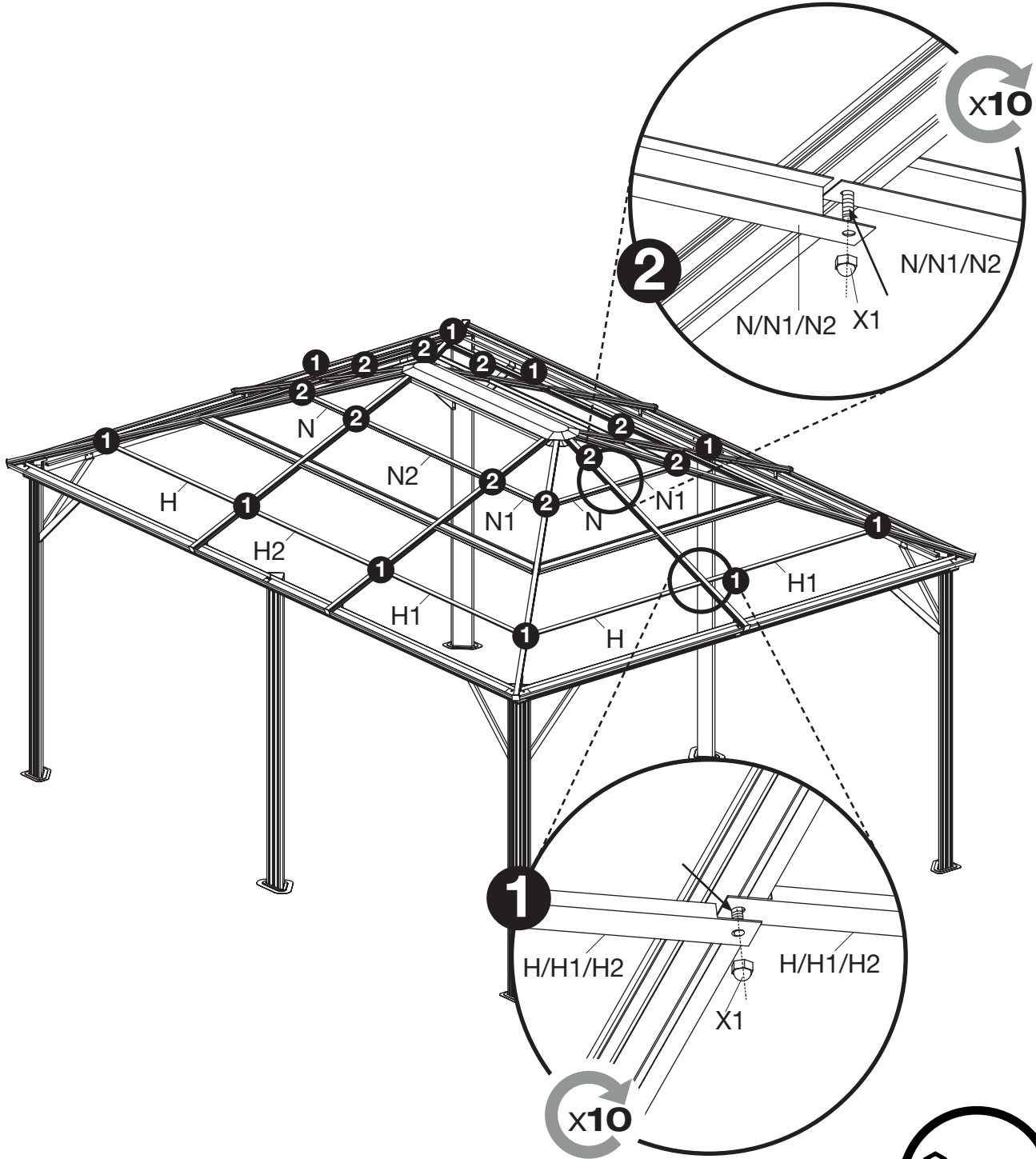

X1 x10



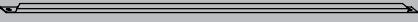

 Hx4	 H2x2	 Nx4	
 H1x4	 N2x2	 N1x4	

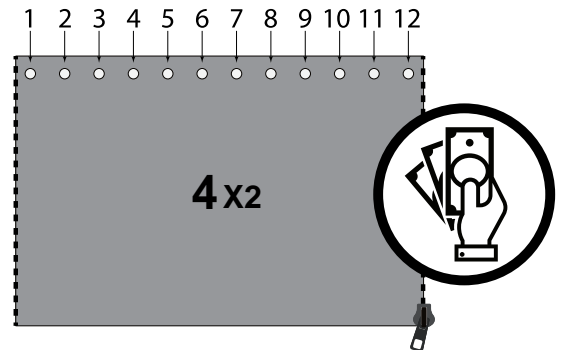
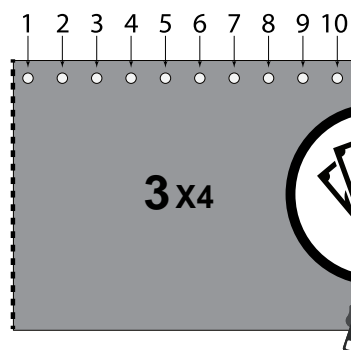
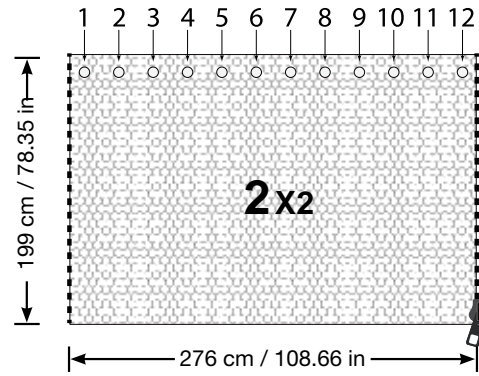
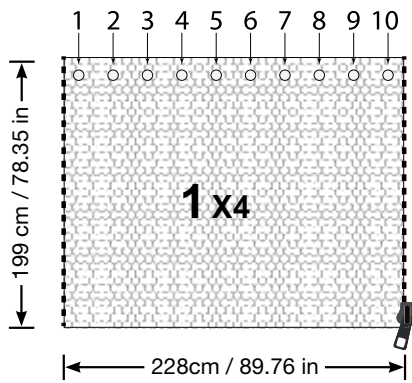
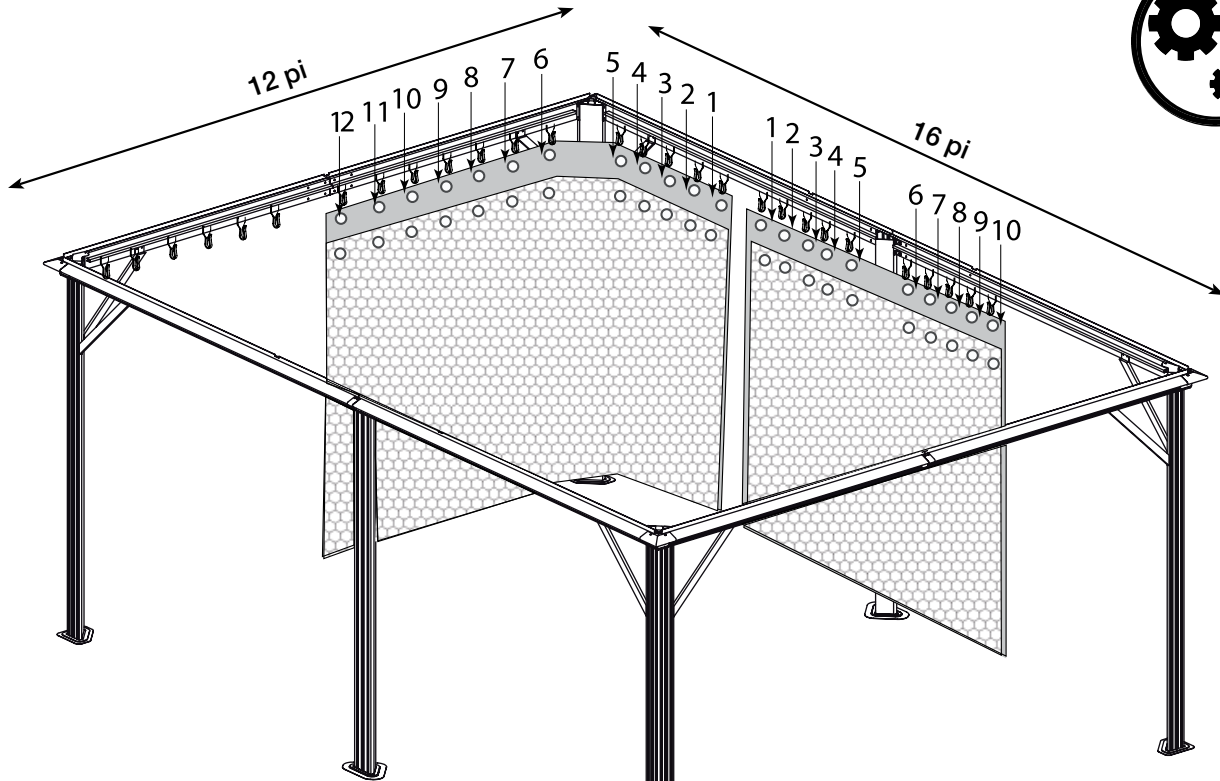

Register • Enregistrer • Regístrate
온라인 등록 • Registrieren

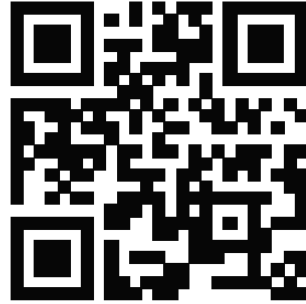
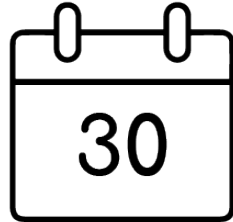

ShelterLogic.com/product-registration

50NRTH GmbH
Straßburgstraße 14-16
Germany 54516 Wittlich
phone +49 (0) 6571 / 95 117- 0
Fax +49 (0) 6571 / 95 117- 98
www.50NRTH.com
info@50NRTH.com



SOJAG ■ I