



# AXI.COM

## Sand / water table

www.axi.com

Gebruikshandleiding  
User manual  
Gebrauchsanweisung  
Mode d'emploi  
Manual de usuario  
Istruzione per l'uso

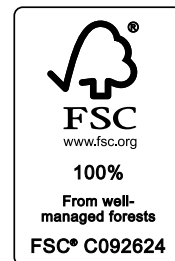
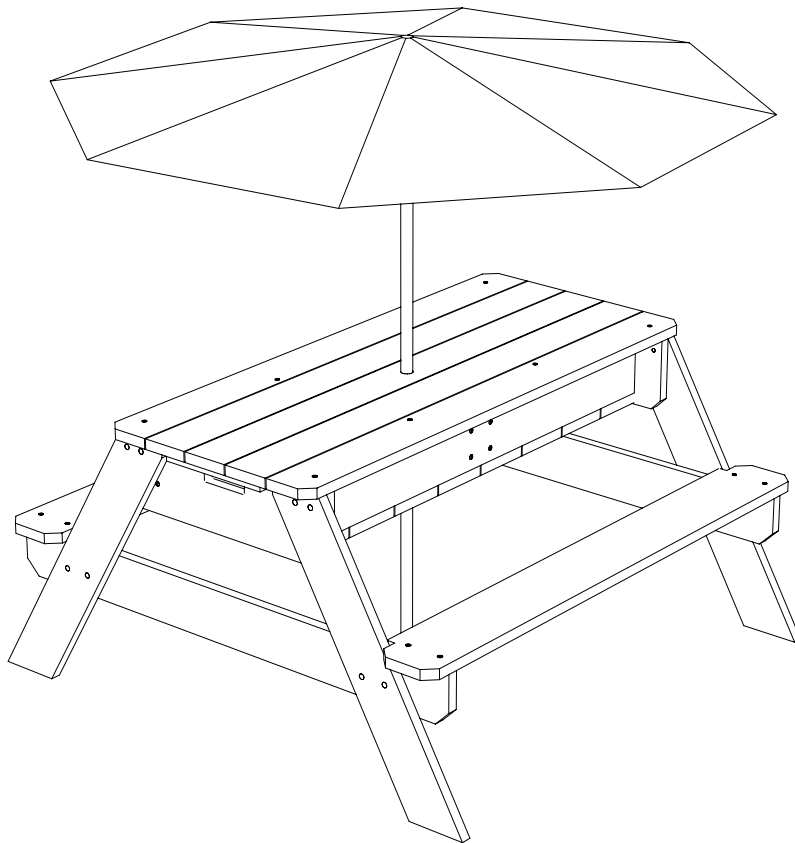

patented product

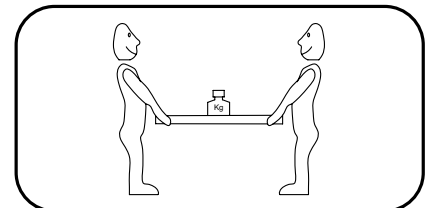
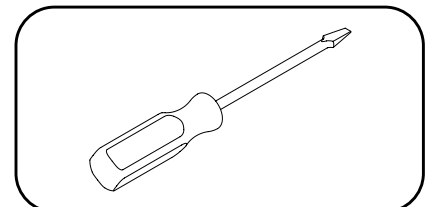

Handleiding bewaren voor later gebruik  
Keep instructions for later use  
Anleitung zum späteren Gebrauch aufbewahren  
Conserver la notice pour usage ultérieur  
Guardar estas Instrucciones para su uso future  
Conservare l'istruzioni per uso successivo



### WARNING

**CHOKING HAZARD**  
small parts  
Not suitable for children under  
36 months



### WARNING

**THE TOY IS TO BE ASSEMBLED BY  
AN ADULT.**



### WARNING

Potential hazard description, e.g. In  
unassembled state contain potentially  
hazardous sharp points, so please  
keep out of baby's reach

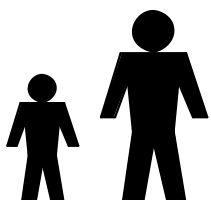

3-7

WWW.AXI.COM

INFO@AXI.COM

date: 12-2012



# Sand / water table

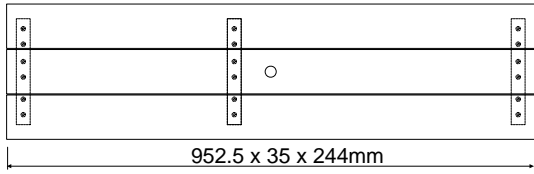

1

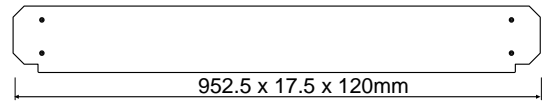

3

2x

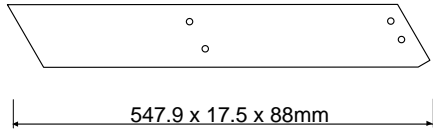

4

4x

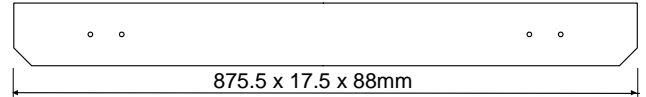

5

2x

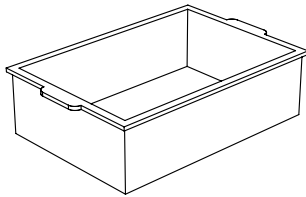

6

2x



7

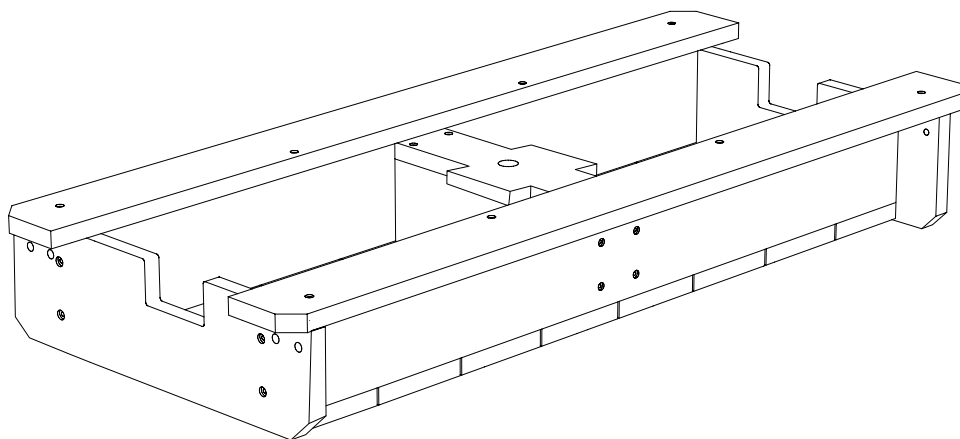

2

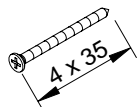

s1

8x



s2

16x



s3

16x



s4

2x

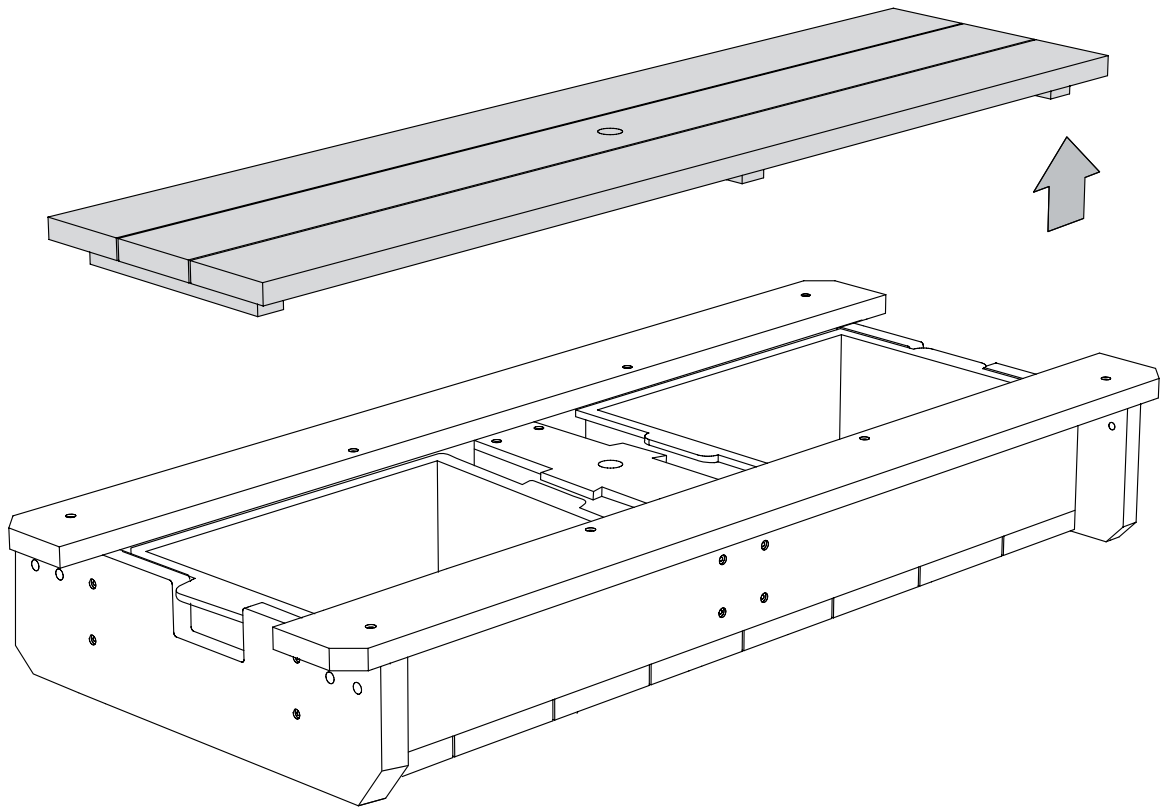
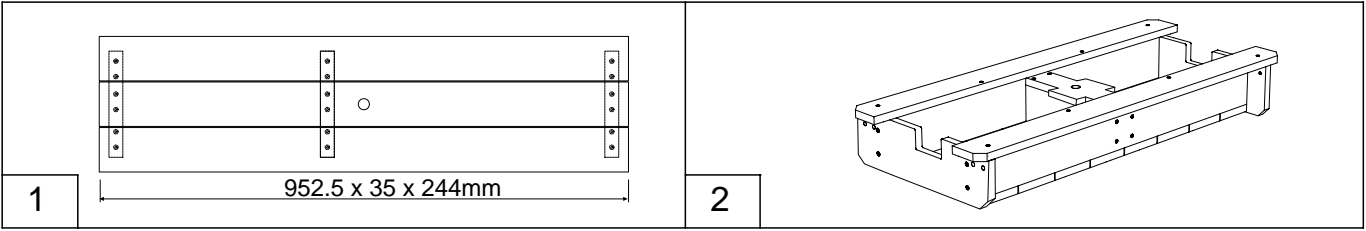



# Sand / water table

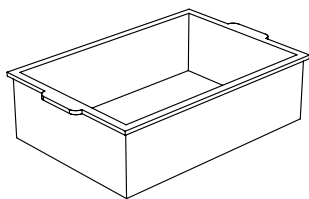

6

2x

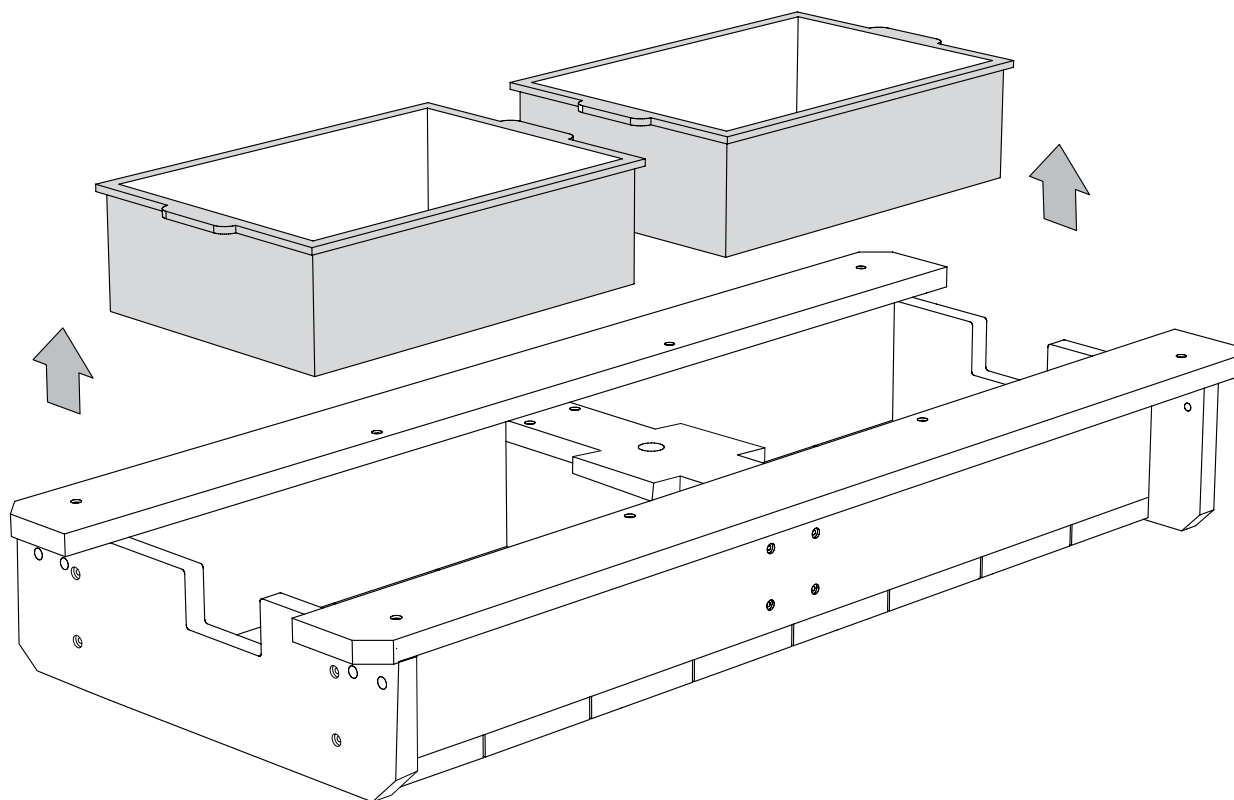



# Sand / water table

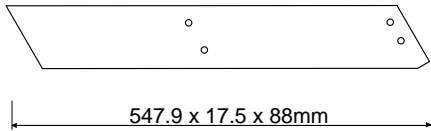

4

4x

s2

8x

s3

8x

s4

2x



FINISH

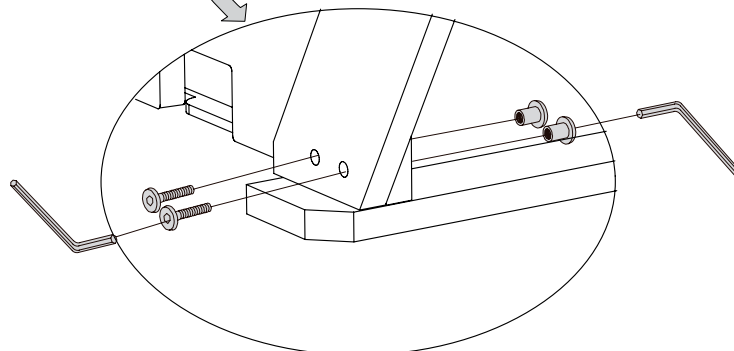
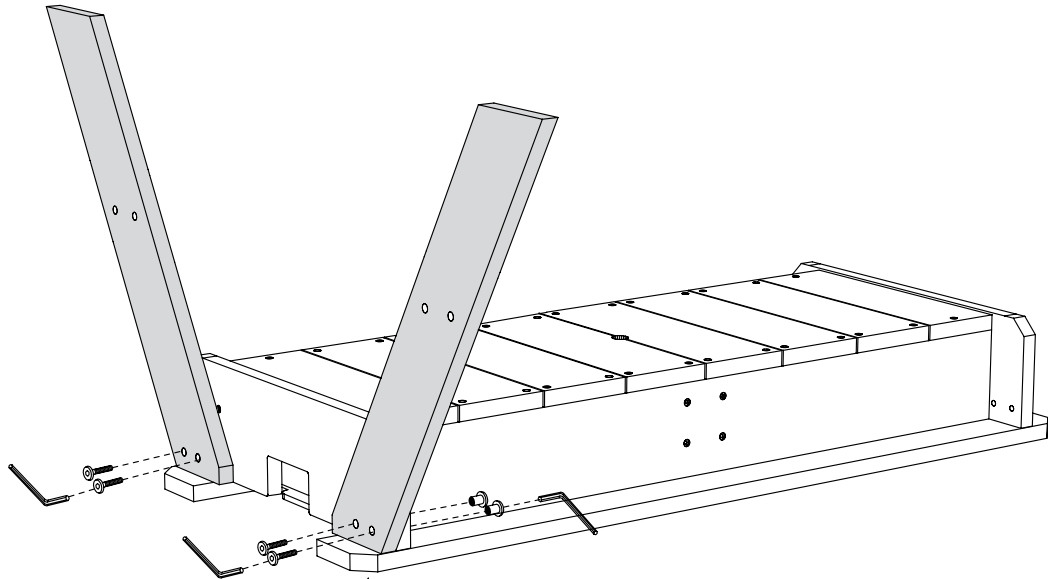
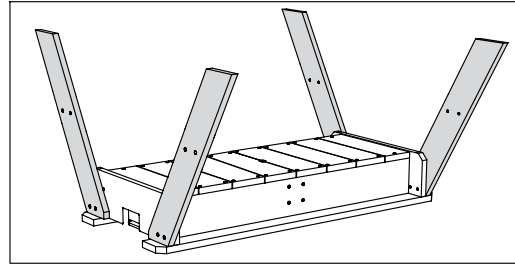



# Sand / water table

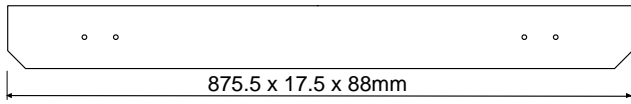

5

2x



s2

8x



s3

8x



s4

2x

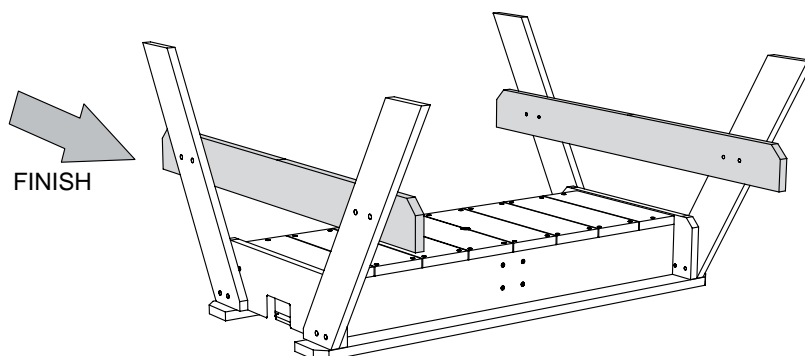
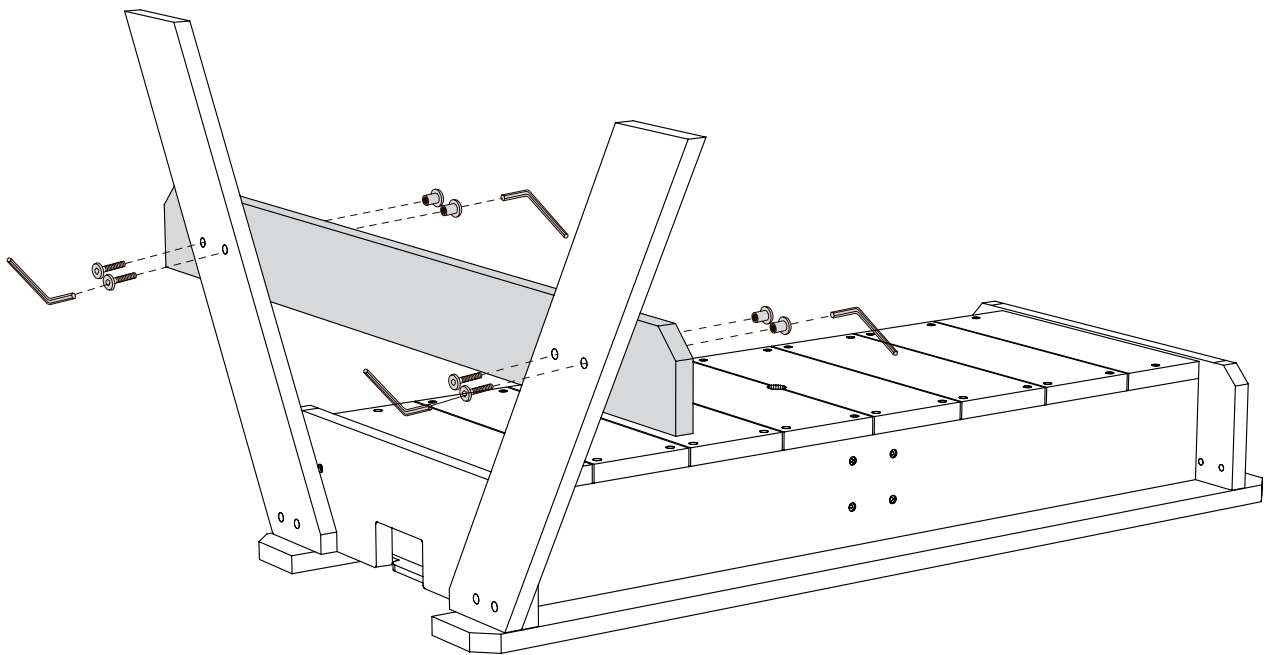



# Sand / water table

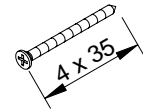
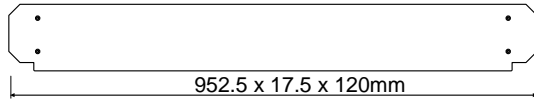

3

2x

S1

8x

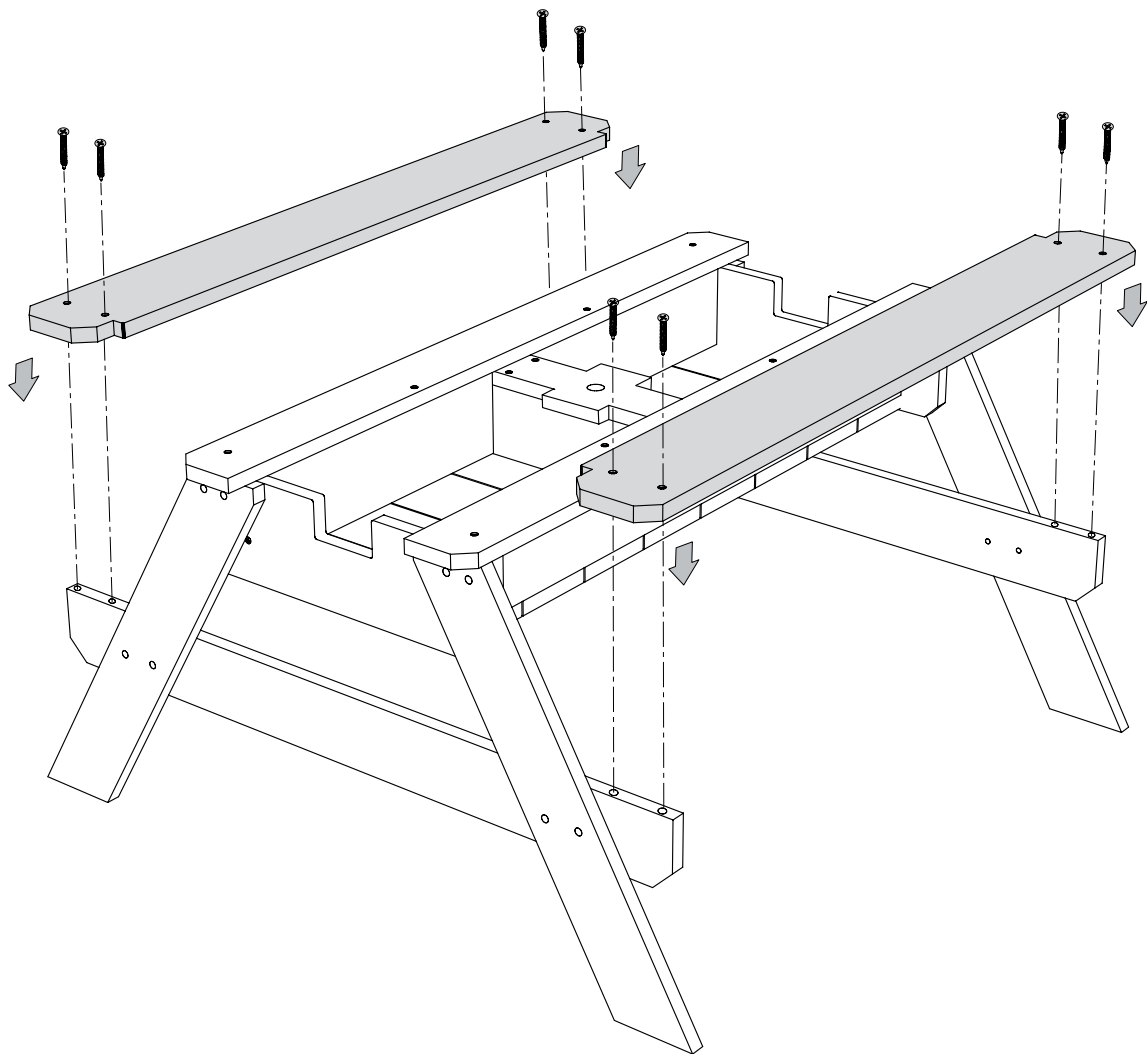

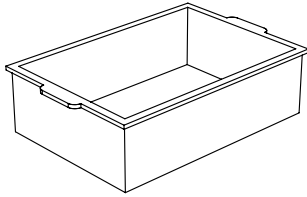

6

2x

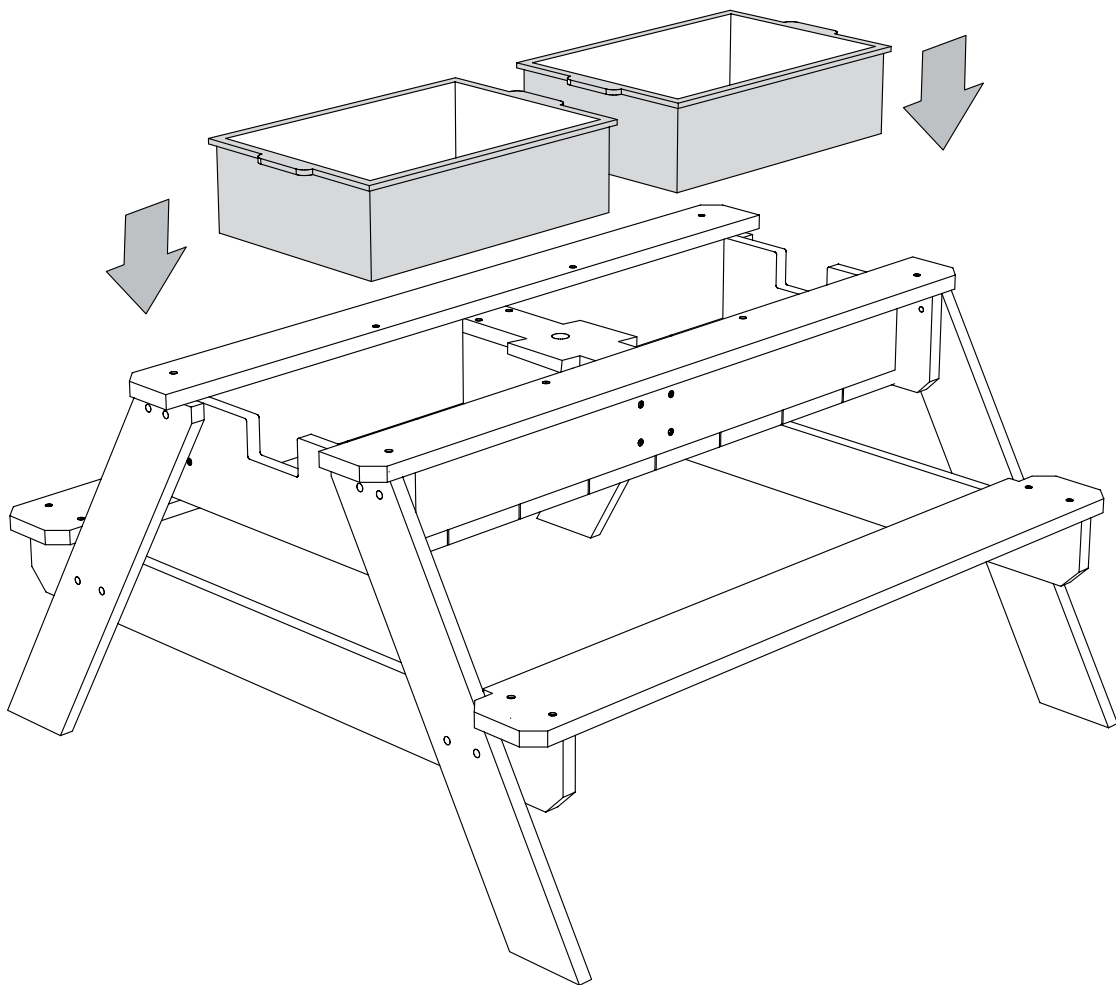



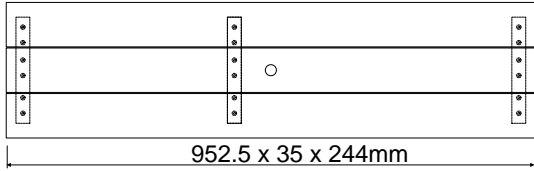

1

952.5 x 35 x 244mm

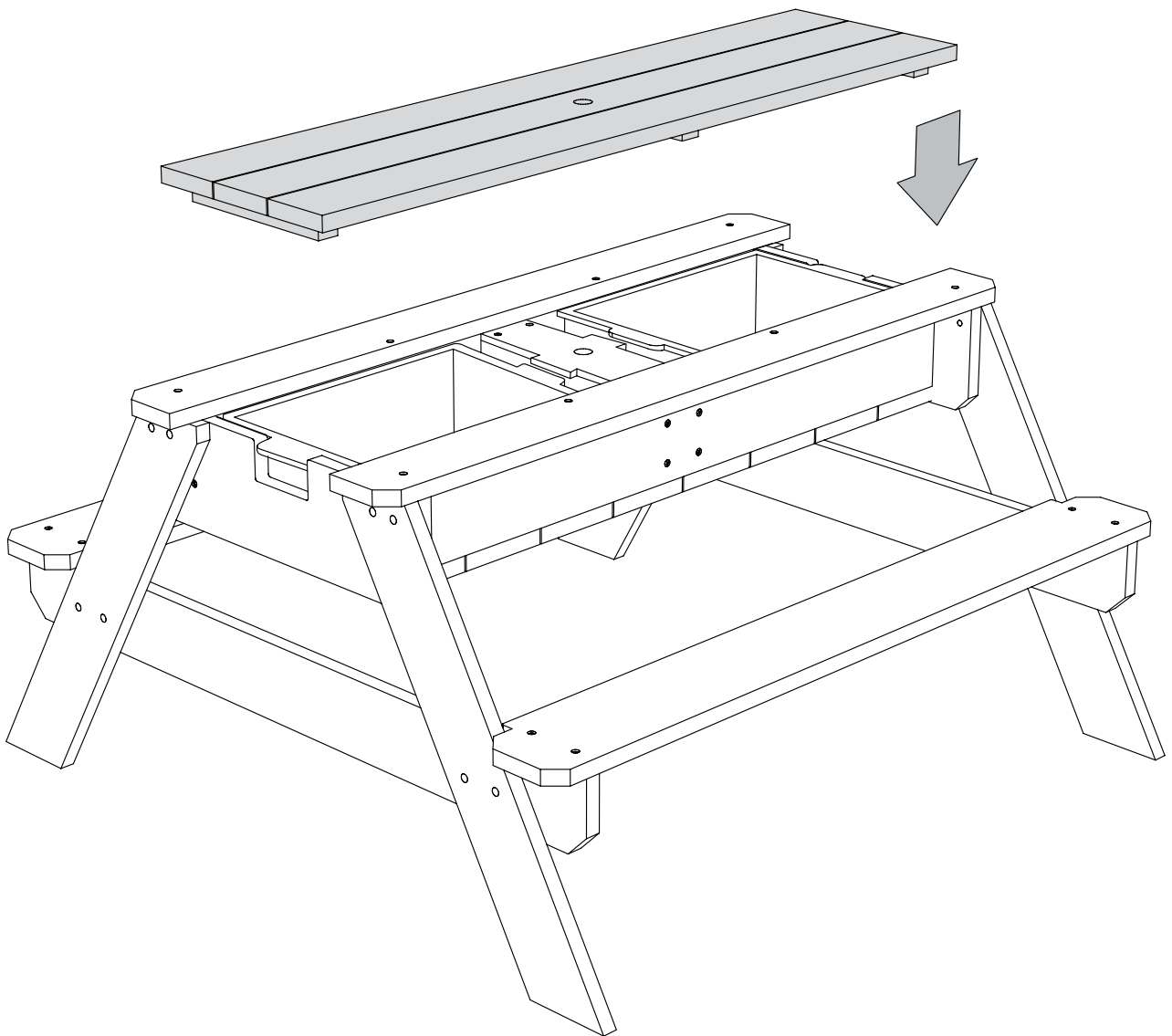



7





AXI.COM verstrekt op de AXI Sandbox with storage bij juist gebruik een garantie van 2 jaar op de verbindingen en accessoires en een garantie van 5 jaar op het hout volgens de algemene garantievoorwaarden.

AXI.COM provides a 2-year guarantee on the AXI Sandbox with storage when properly used in respect of the joints and accessories and a guarantee of five years on the wood according to the general guarantee terms & conditions”

AXI.COM gibt entsprechend den allgemeinen Garantiebestimmungen für die AXI Sandbox with storage bei richtiger Verwendung eine Garantie von 2 Jahren auf die Verbindungen und das Zubehör sowie eine Garantie von 5 Jahren auf das Holz.

Sur le AXI Sandbox with storage, AXI.COM offre une garantie de 2 ans pour les raccords et accessoires ainsi qu’une garantie de 5 sur le bois, à condition de l’utiliser de manière adéquate et conformément aux conditions générales de la garantie.

AXI.COM ofrece una garantía de 2 años a las conexiones y accesorios de AXI Sandbox with storage, siempre que se utilicen de forma adecuada, y una garantía de 5 años a la madera de acuerdo con las condiciones de garantía generales.

Il AXI Black / chalkboard - fermo restando un idoneo utilizzo - da una garanzia AXI.COM di 2 anni sui giunti e sugli accessori e di 5 anni sui materiali lignei, secondo quanto previsto dalle condizioni generali di garanzia.



# Sand / water table