

18+

MONTHS / MONATE

PLAYHOUSE USED
WITHOUT A DECK
SPIELHAUS OHNE
DECK VERWENDBAR

3+

YEARS / JAHRE

PLAYHOUSE USED
WITH A DECK
SPIELHAUS AUF EINEM
DECK VERWENDET



PLAYHOUSE USED
WITH A DECK
SPIELHAUS AUF EINEM
DECK VERWENDET

ASSEMBLY / MONTAGE



x2 Person build



1.5hr Build time

! **50kg**

MAXIMUM COMBINED
USER WEIGHT
MAXIMALES
KOMBINIERTES
BENUTZERGEWICHT

PLAYHOUSE USED
WITHOUT A DECK
SPIELHAUS OHNE
DECK VERWENDBAR

! **100kg**

MAXIMUM COMBINED
USER WEIGHT
MAXIMALES
KOMBINIERTES
BENUTZERGEWICHT

PLAYHOUSE USED
WITH A DECK
SPIELHAUS AUF EINEM DECK
VERWENDET

Instructions for assembly, maintenance and safe use.

Anweisungen für Montage, Wartung und sicheren Gebrauch.



WARNINGS!

EN

- **PLAYHOUSE USED WITHOUT A DECK** - THIS PRODUCT IS INTENDED FOR USE BY CHILDREN FROM AGES 18+ MONTHS - MAXIMUM USER WEIGHT PER USER 30KGS - MAXIMUM COMBINED USER WEIGHT FOR THIS PRODUCT 50 KGS
- **PLAYHOUSE USED ON A DECK** - THIS PRODUCT IS INTENDED FOR USE BY CHILDREN FROM AGES 3+ YEARS - MAXIMUM USER WEIGHT PER USER 30KGS - MAXIMUM COMBINED USER WEIGHT FOR THIS PRODUCT 100 KGS
- THIS PRODUCT CONTAINS COMPONENTS THAT HAVE SMALL PARTS AND SHARP POINTS. IT IS NOT SUITABLE FOR CHILDREN UNDER 36 MONTHS UNTIL FULLY ASSEMBLED.
- ONLY FOR DOMESTIC USE. FOR OUTDOOR USE ONLY.
- TOY MUST BE ASSEMBLED BY AN ADULT BEFORE USE.
- CHILDREN MUST NOT USE THIS PRODUCT UNTIL PROPERLY INSTALLED.
- ADULT SUPERVISION REQUIRED.
- KEEP AWAY FROM FIRE.
- REMOVE ALL PACKAGING BEFORE GIVING TO YOUR CHILDREN.
- RETAIN PACKAGING FOR FUTURE REFERENCE.
- PLEASE RETAIN INSTRUCTIONS AS IT CONTAINS IMPORTANT SAFETY INFORMATION.

Instructions for assembly, maintenance and safe use.

Please retain this information for future reference.

1. Toy must be assembled by an adult before use exactly in accordance with the instructions.
2. Children must not use this product until properly installed.
3. Check all parts are present before you start to assemble the product. Place small parts on a tray or similar to ensure they are not lost. The manufacturing process can very occasionally result in sharp edges/waste material so please take care when assembling this product.
4. If any parts are missing do not use the product until the replacement parts are fitted.
5. Ensure your product is sited on level ground. Failure to do this may put additional stress on connections and joints and in time could cause them to fail.
6. Ensure your product is located on a soft impact surface like grass. Never locate your product on hard surfaces like concrete.
7. Avoid locating this product in full sun.
8. Remove all packaging before giving to your children.
9. Equipment should be checked by an adult at the beginning of each season and at regular intervals during the usage season to ensure it is safe. Pay special attention to all connections and fastenings.
10. Parts may need to be replaced if they show signs of wear and tear. Replace any defective parts in accordance with these instructions.
11. Due to the natural characteristics of timber, it is vital to check your playframe regularly for splintering, lifting of surface layers of wood or exposure of rough wood. Affected areas must be rubbed down using coarse sandpaper to restore a smooth, safe surface.
12. Any changes to this toy eg changing or adding an accessory, must be done in accordance with our instructions. Failure to do this will render your guarantee null and void and may make your product unsafe.
13. Ensure children's clothing is appropriate for the play activity.
14. Never place toys near a fire.
15. In high winds, ensure outdoor toys are moved to a sheltered position and/or securely staked down.
16. The age recommendation for this product is clearly stated on the packaging and in these instructions. Please adhere to it at all times. Adult supervision is required at all times to ensure children play safely.
17. When you dispose of this equipment please do so responsibly.



WARNUNG!

DE

- **SPIELHAUS OHNE DECK VERWENDBAR** - DIESES PRODUKT IST FÜR KINDER AB EINEM ALTER VON 18+ MONATEN BESTIMMT - MAXIMALES BENUTZERGEWICHT PRO BENUTZER: 30 KG - MAXIMALES KOMBINIERTES BENUTZERGEWICHT 50 KG
- **SPIELHAUS AUF EINEM DECK VERWENDET** - DIESES PRODUKT EIGNET SICH FÜR KINDER ZWISCHEN 3 + JAHRE - MAXIMALES BENUTZERGEWICHT PRO BENUTZER: 30 KG - MAXIMALES KOMBINIERTES BENUTZERGEWICHT 100 KG
- DIESES PRODUKT ENTHÄLT KOMPONENTEN MIT KLEINEN TEILEN UND SCHARFEN SPITZEN. IST FÜR KINDER UNTER 36 MONATEN BIS ZUR VOLLSTÄNDIGEN MONTAGE NICHT GEEIGNET.
- NUR FÜR DEN HÄUSLICHEN GEBRAUCH. FÜR DRAUSSEN.
- DAS SPIELZEUG MUSS VOR GEBRAUCH VON EINEM ERWACHSENEN GENAU NACH ANLEITUNG ZUSAMMENGEBAUT WERDEN.
- KINDER DÜRFEN DAS PRODUKT NICHT BENUTZEN, BEVOR ES NICHT KORREKT AUFGEBAUT WURDE.
- AUFSICHT DURCH EINEN ERWACHSENEN ERFORDERLICH.
- VON FEUER FERNHALTEN.
- ALLE VERPACKUNGEN ENTFERNEN, BEVOR IHRE KINDER DAS PRODUKT ERHALTEN ODER DAMIT SPIELEN DÜRFEN.
- BITTE DIE VERPACKUNG FÜR ZUKÜNFTIGE VERWENDUNG AUFHEBEN. BITTE DIE ANLEITUNG AUFBEWAHREN – SIE ENTHÄLT WICHTIGE SICHERHEITSHINWEISE

Zusammenbau-, Wartungs- und Gebrauchsanweisungen.

Bitte diese Informationen zur späteren Bezugnahme aufbewahren.

1. Das Spielzeug muss vor Gebrauch von einem Erwachsenen genau nach Anleitung zusammengebaut werden.
2. Kinder dürfen das Produkt nicht benutzen, bevor es nicht korrekt aufgebaut wurde
3. Vor Zusammenbau des Produkts überprüfen, dass alle Teile vorhanden sind. Kleine Teile auf ein Tablett oder Ähnliches legen, damit sie nicht verloren gehen. Der Herstellungsprozess kann gelegentlich zu scharfen Kanten/Materialresten führen; seien Sie daher vorsichtig beim Zusammenbau dieses Produkts.
4. Sollten irgendwelche Teile fehlen, das Produkt nicht verwenden, bis die Ersatzteile angebracht wurden.
5. Sicherstellen, dass das Produkt auf ebenem Untergrund steht. Bei Nichtbeachtung können die Verbindungsstücke und Gelenke zusätzlicher Belastung ausgesetzt werden und versagen.
6. Sicherstellen, dass Ihr Produkt auf weichem Boden wie Gras steht. Das Produkt niemals auf hartem Boden wie Beton aufstellen.
7. Diese Produkt nicht in der vollen Sonne aufstellen.
8. Alle Verpackungen entfernen, bevor Ihre Kinder das Produkt erhalten oder damit spielen dürfen.
9. Geräte sollte zu Beginn jeder Saison sowie regelmäßig während der Gebrauchssaison von einem Erwachsenen überprüft werden, um ihre Sicherheit zu gewährleisten. Besonders auf alle Verbindungen und Befestigungen achten.
10. Teile müssen bei Abnutzungserscheinungen u. U. ersetzt werden. Alle fehlerhaften Teile gemäß diesen Anleitungen ersetzen.
11. Aufgrund der natürlichen Eigenschaften von Holz ist es sehr wichtig, Ihren Spielrahmen regelmäßig auf Splitter sowie abgehobene Oberflächen und raues Holz zu überprüfen. Betroffene Bereiche mit grobem Schleifpapier abschmirgeln, um wieder eine glatte, sichere Oberfläche zu schaffen.
12. Bei allen Abänderungen des Spielzeugs, z. B. Auswechseln oder Hinzufügen von Zubehör, unsere Anleitungen befolgen. Nichtbeachtung führt zum Erlöschen Ihrer Garantie und kann bedeuten, dass Ihr Produkt nicht länger sicher ist.
13. Für die Spielaktivität geeignete Kinderkleidung wählen.
14. Niemals Spielzeug in der Nähe von Feuer aufstellen.
15. Bei starkem Wind sicherstellen, dass Spielzeug für draußen an eine geschützte Position verlegt wird und/oder fest verankert ist.
16. Das empfohlene Alter für dieses Produkt ist deutlich auf der Verpackung und in diesen Anleitungen angegeben. Bitte sich stets daran halten. Aufsicht durch Erwachsene ist steht erforderlich, um die Sicherheit von Kindern beim Spielen zu gewährleisten.
17. Bitte dieses Gerät verantwortungsvoll entsorgen.

Safe Play Area Sicherer Spielbereich

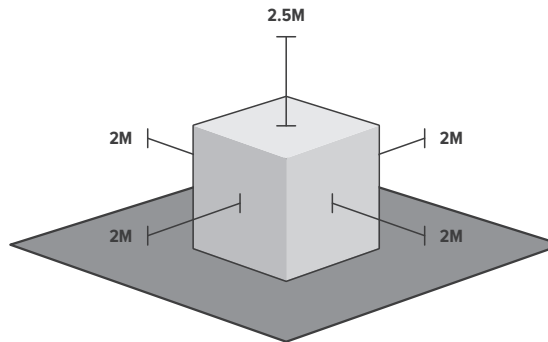

EN

The safe play area refers to the zone extending 200cm around the toys on all sides and 250 cm above the toy. The safe play area must be free from all obstacles.

DE

Der sichere Spielbereich bezieht sich auf eine Zone von 200 cm rund um das Spielzeug sowie 250 cm oberhalb des Spielzeugs. Der sichere Spielbereich muss frei von allen Hindernissen sein.

Dimensions • Maße

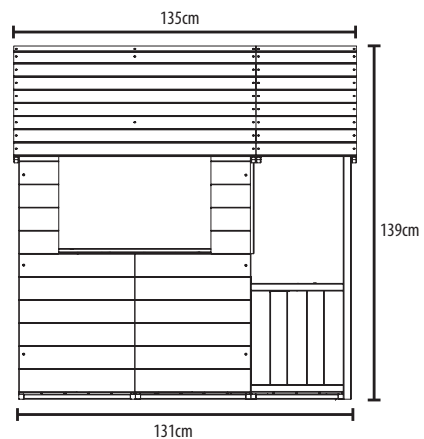
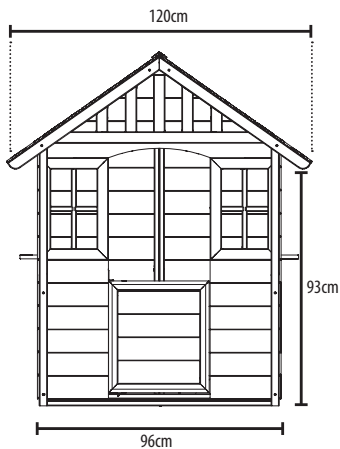

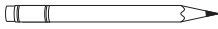

NOT INCLUDED - NICHT ENTHALTEN

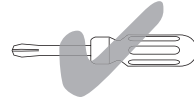
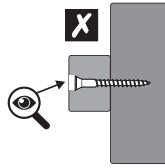
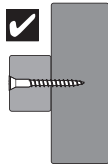

6 Contents • Inhalt



MW9275-WHT x4



MW9289-WHT x4



MW9309 x2



MW9318-7047 x1



MW2217-WHT x1



MW9340-WHT x1



MW9315 x2



MW9312-7047 x2



MW9317-7047 x1



MW9341-7047 x1

MW9314-WHT x12

MW9316-WHT x4

MW9290 x2

PM1970 x1

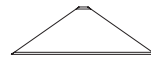

MW2113-WHT x1



MW9319-WHT x16



MW9291 x2



MW2116-7047 x1

SP5395



3.5 x 16mm x22
FA4529



3.5 x 35mm x21
FA4525



3.5 x 50mm x10
FA4523



PR5373 x1

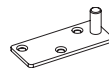

PR6859B x1

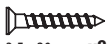

3.5 x 20mm x80
FA4542

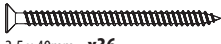

3.5 x 40mm x36
FA4522

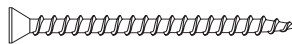

3.5 x 60mm x4
FA4541



FA6210 x2
M6x12mm



PR6960 x1



3.5 x 30mm x19
FA4513

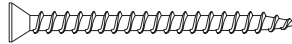

4 x 60mm x2
FA4557

Contents • Inhalt

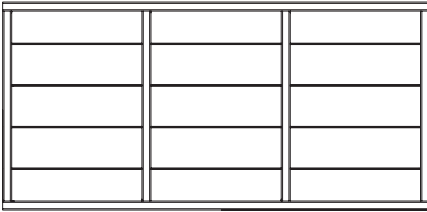

WP3000 **x1**

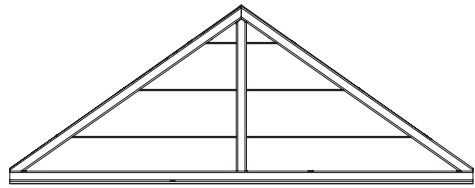

WP3011-7047 **x1**

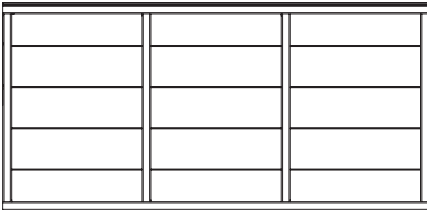

WP3001 **x1**

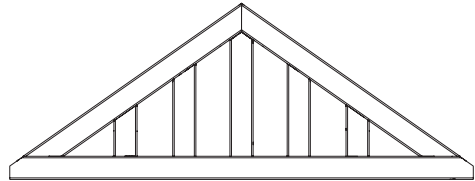

WP3016 **x1**

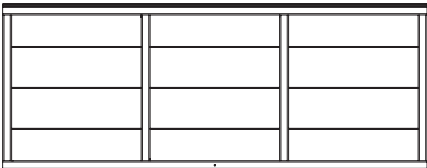

WP3002 **x1**

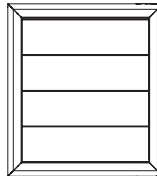

WP3015 **x1**

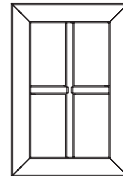

WP3022-WHT **x2**

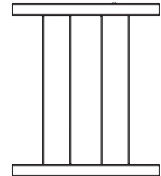

WP3019-WHT **x2**

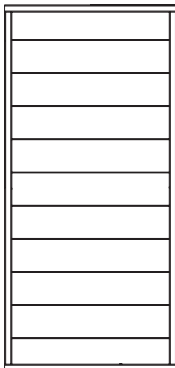

WP3003-7047 **x1**

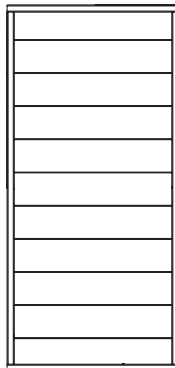

WP3004-7047 **x1**

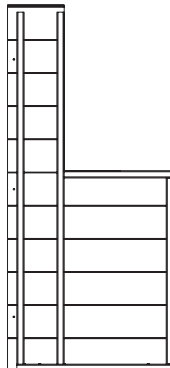

WP3007-7047 **x2**

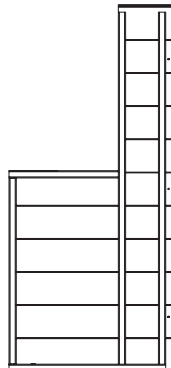

WP3008-7047 **x2**

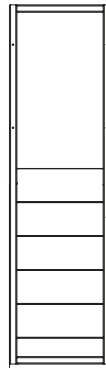

WP3020-7047 **x1**



WP3021-7047 **x1**

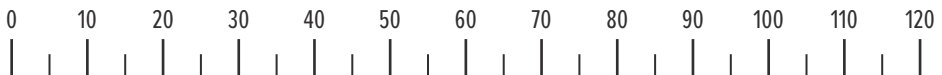

MM

1

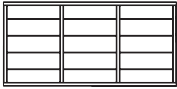

WP3000 **x1**



WP3001 **x1**

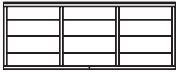

WP3002 **x1**



FA4525 - 3.5 x 35mm **x6**

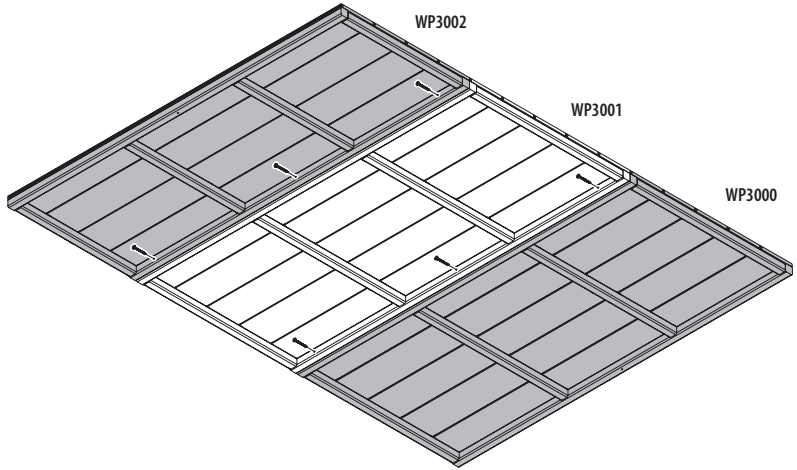

2



FA4522 - 3.5 x 40mm **x8**



WP3021-7047 **x1**



WP3020-7047 **x1**



MW9317-7047 **x1**



MW9341-7047 **x1**

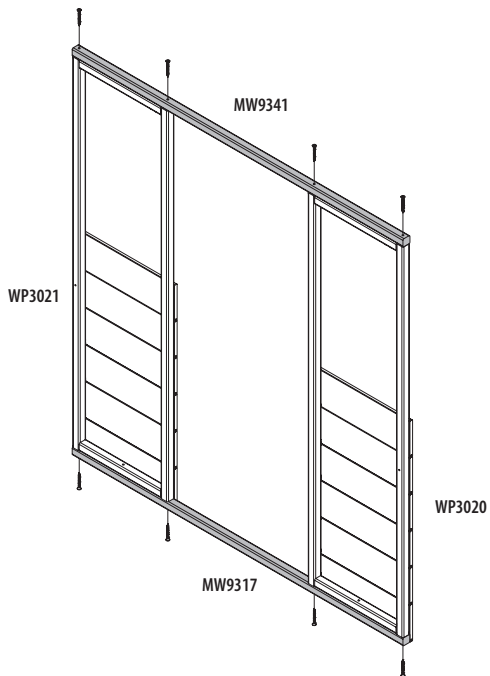

3

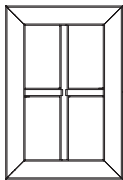

WP3022-WHT x2



FA4526 - 3.5 x 30mm x8

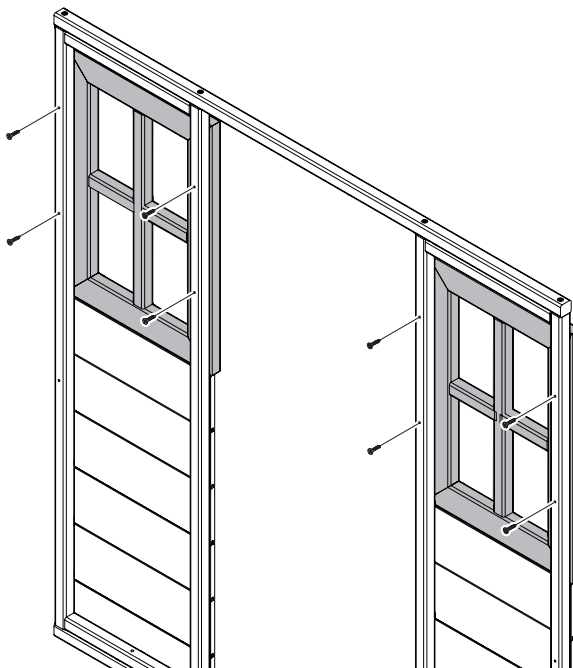

4

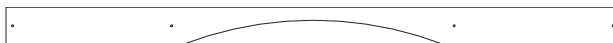

MW9318-7047 x1



FA4529 - 3.5 x 16mm x4

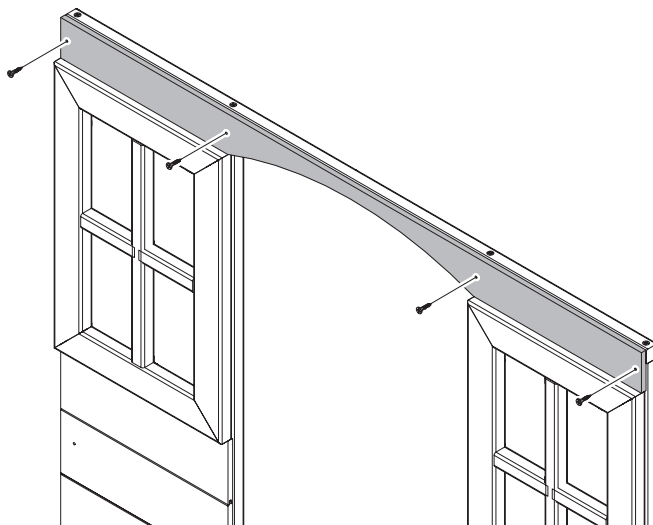

7

5



PR5373 x1

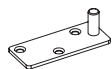

PR6859B x1

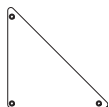

PR6960 x1

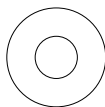

FA6210 x2
M6x12mm

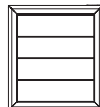

WP3015 x1



FA4529 - 3.5 x 16mm x8

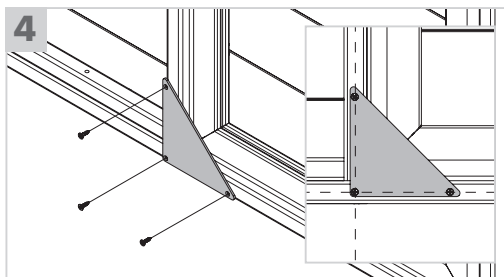
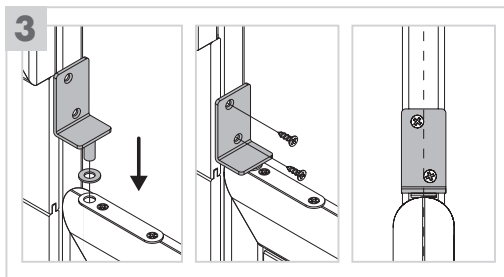
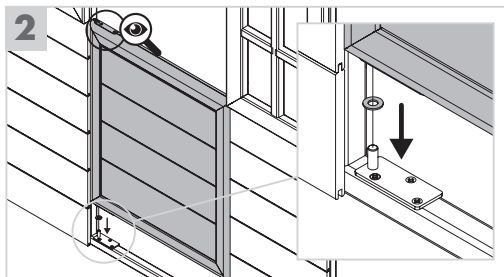
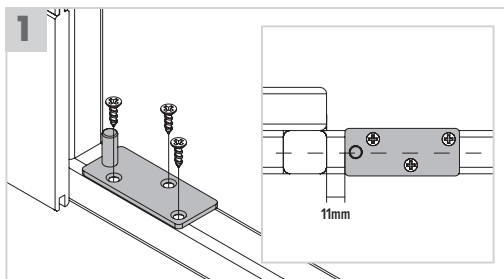
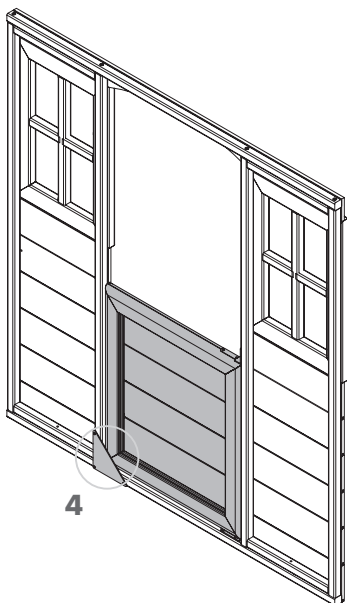
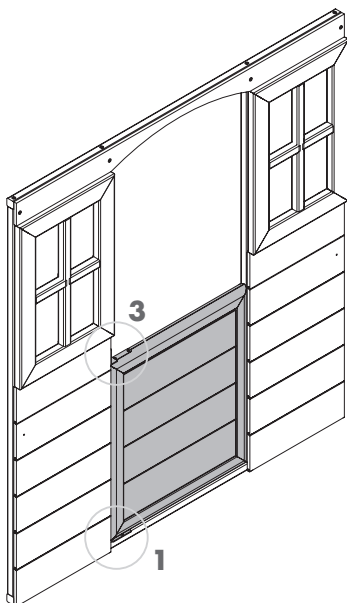

6

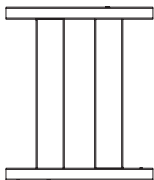

WP3019-WHT x2

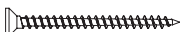

FA4523 - 3.5 x 50mm x4

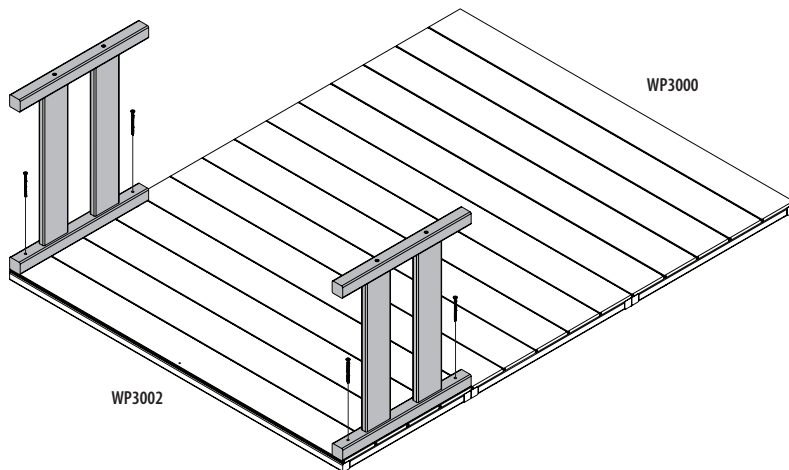

7

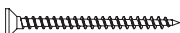

FA4541 - 3.5 x 60mm x4

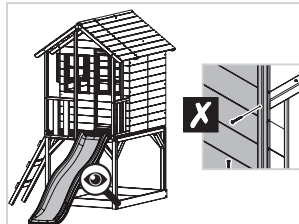
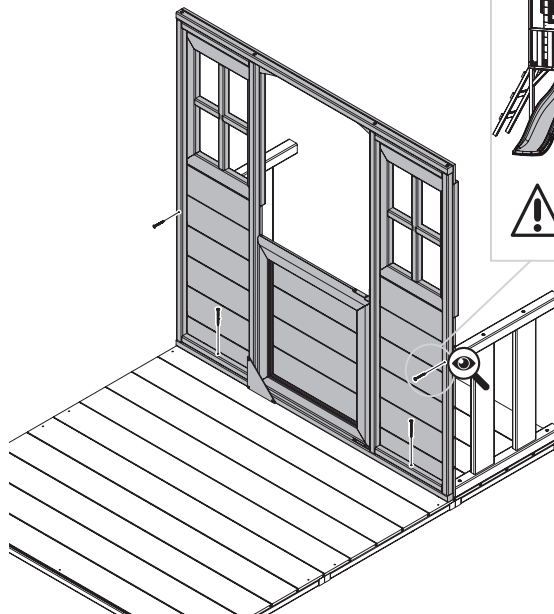

EN - DO NOT ADD SCREW IF PLAYHOUSE BEING ADDED TO A DECK WITH SLIDE.
DE - FÜGEN SIE KEINE SCHRAUBE HINZU, WENN DAS SPIELHAUS AN EINE TERRASSE MIT RUTSCHE ANGEBAUT WIRD.

8



FA4513 - 3.5 x 30mm **x8**



FA4525 - 3.5 x 35mm **x4**



FA4522 - 3.5 x 40mm **x8**

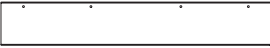

MW9309 **x2**



WP3007-7047 **x2**

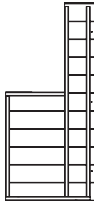

WP3008-7047 **x2**

MW9312-7047 **x2**

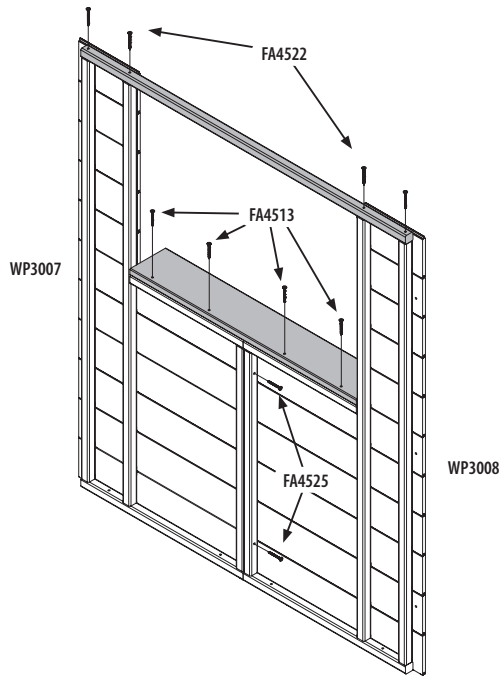

9



FA4535 - 3.5 x 20mm **x3**



FA4522 - 3.5 x 40mm **x4**

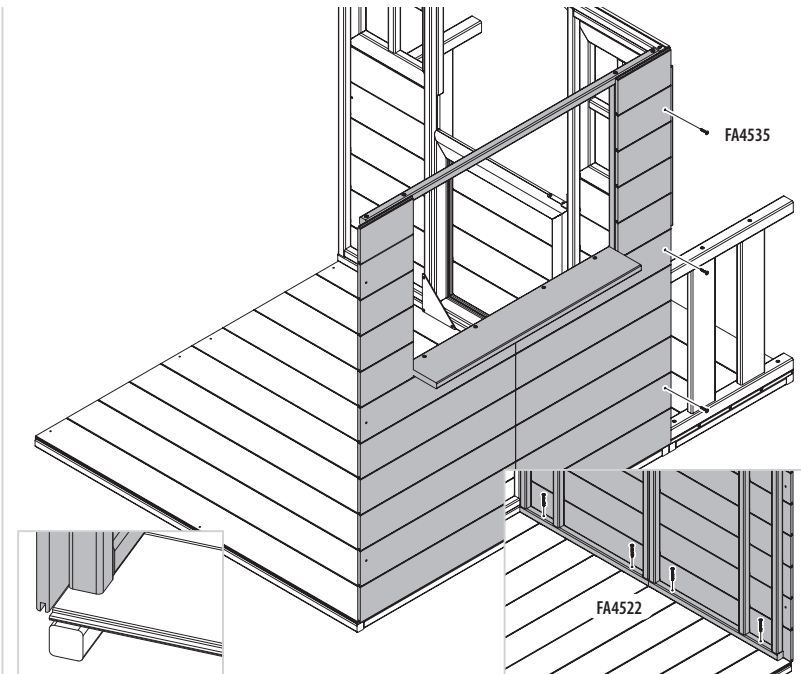

10



FA4535 - 3.5 x 20mm **x3**



FA4522 - 3.5 x 40mm **x4**

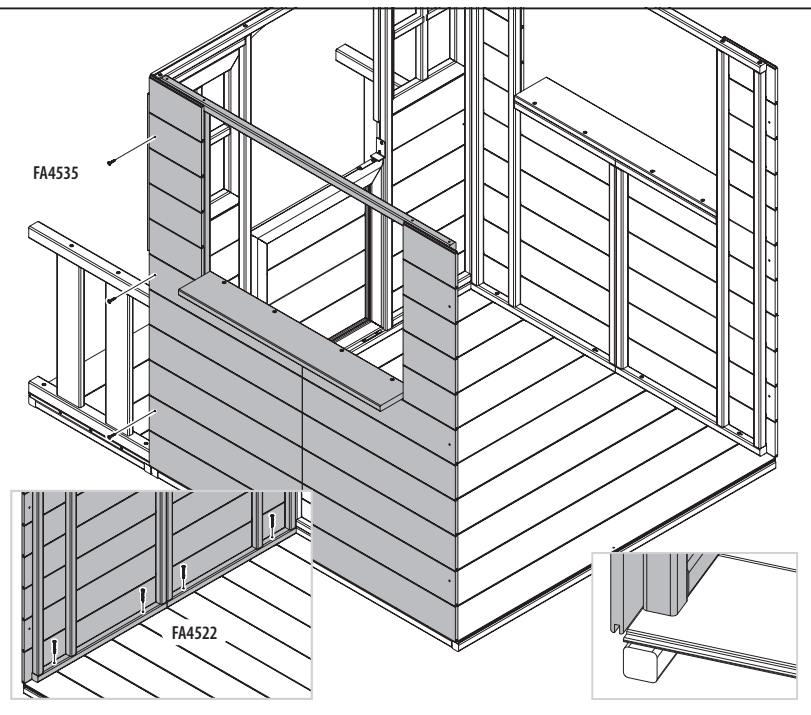

11



FA4525 - 3.5 x 35mm **x3**

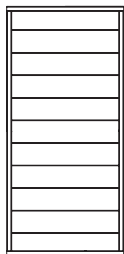

WP3003-7047 **x1**

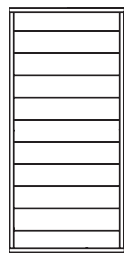

WP3004-7047 **x1**

WP3003

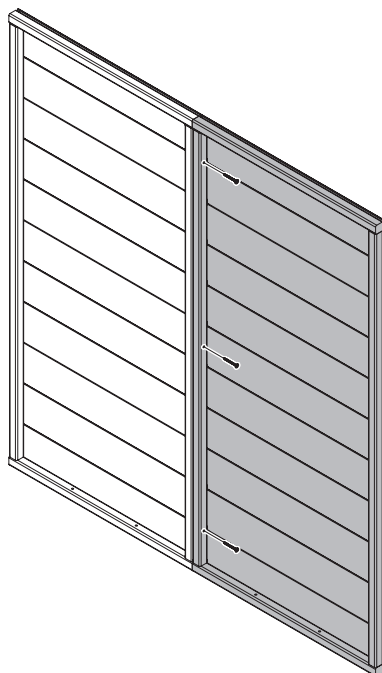

WP3004

12



FA4535 - 3.5 x 20mm x6

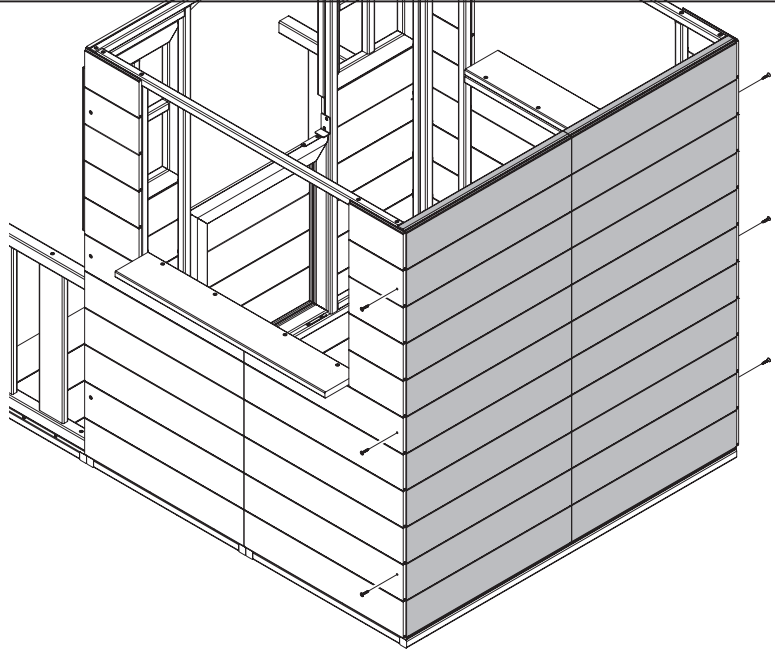

13



FA4522 - 3.5 x 40mm x4

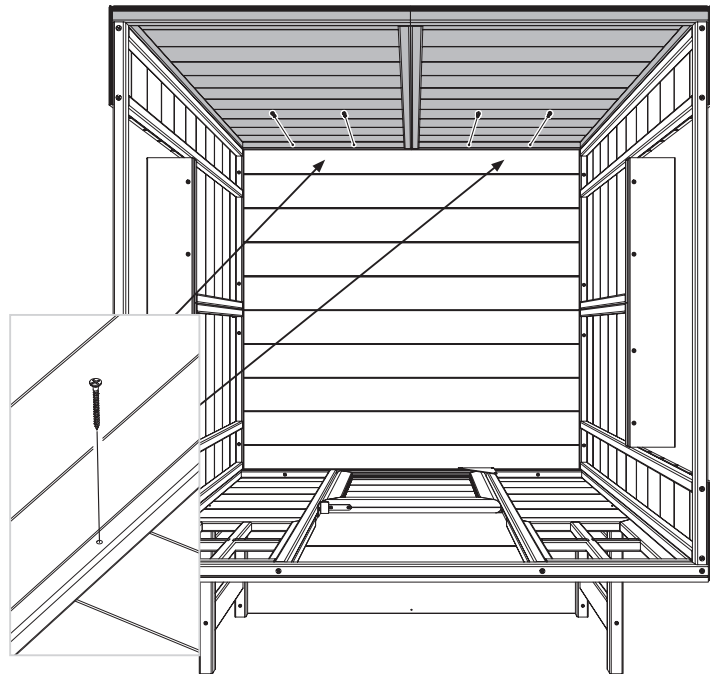

14



WP3011-7047 x1



FA4525 - 3.5 x 35mm x2

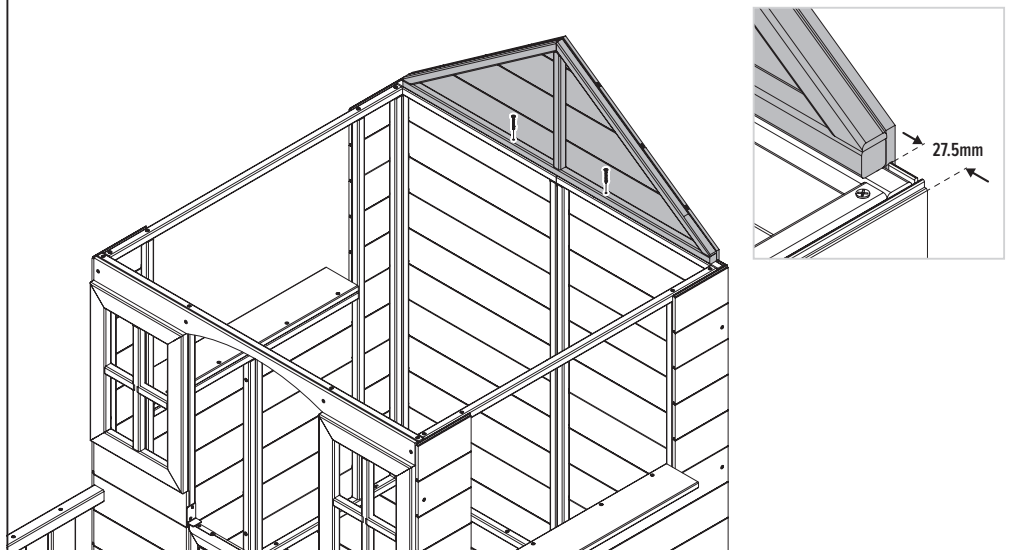

15

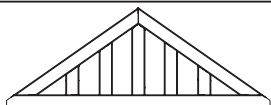

WP3016 x1



FA4557 - 4 x 60mm x2

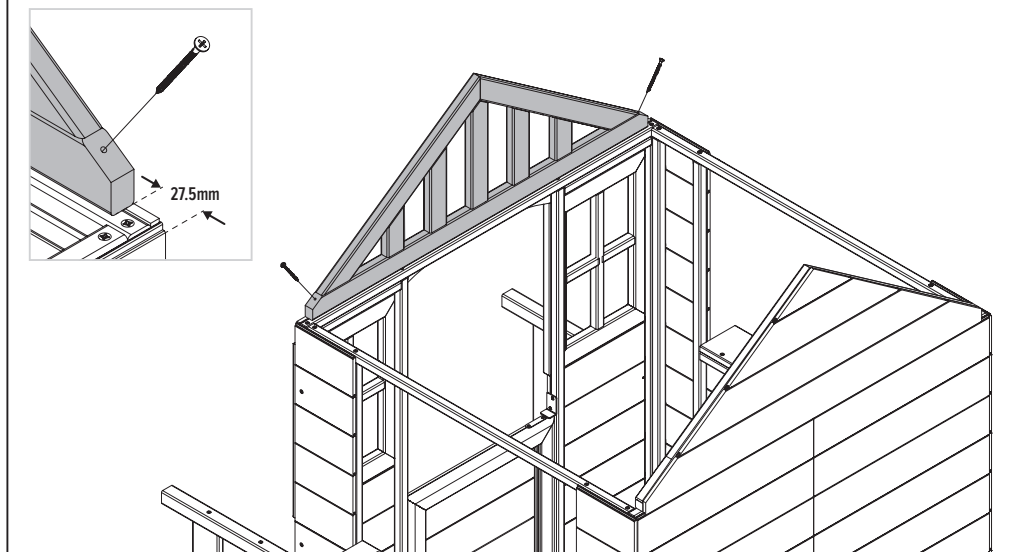
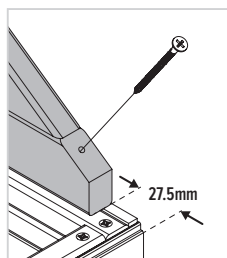

16



MW9314-WHT **x12**

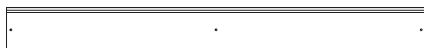

MW9316-WHT **x4**



MW9289-WHT **x4**



FA4535 - 3.5 x 20mm **x32**

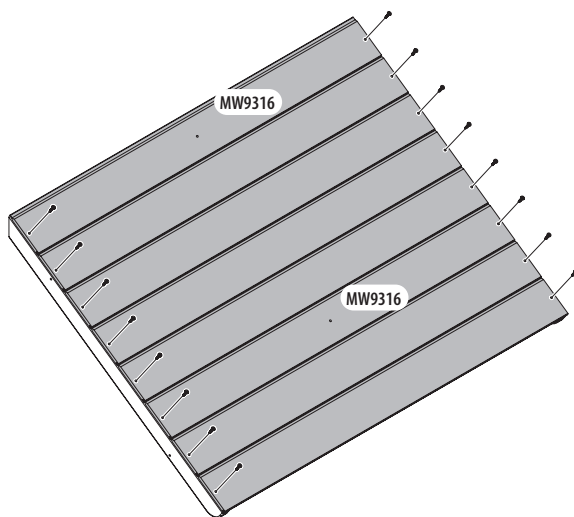
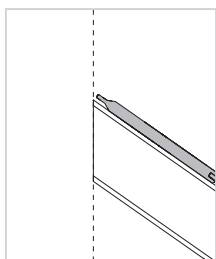

x2

17



MW9315-WHT **x2**



FA4535 - 3.5 x 20mm **x4**

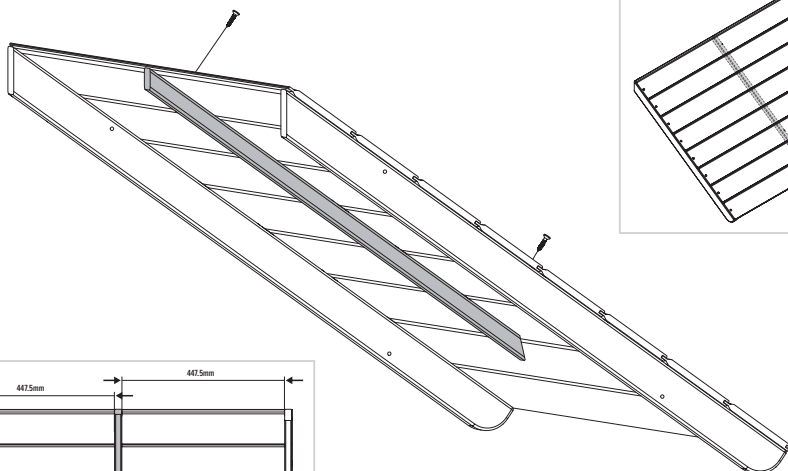

x2

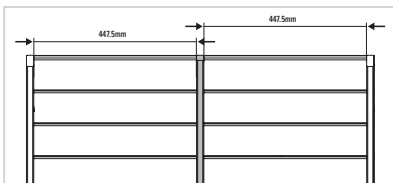

18



FA4522 - 3.5 x 40mm x2



FA4525 - 3.5 x 35mm x2

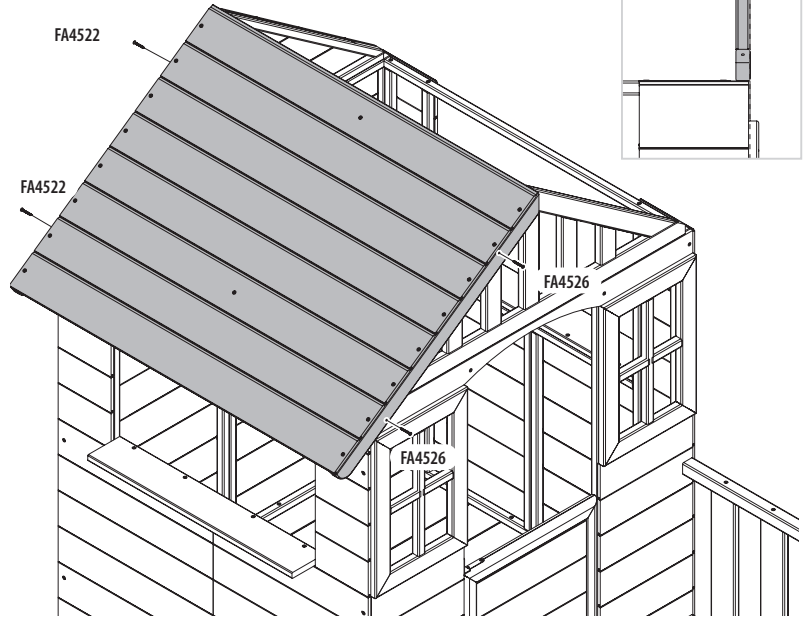

19



FA4522 - 3.5 x 40mm x2



FA4525 - 3.5 x 35mm x2

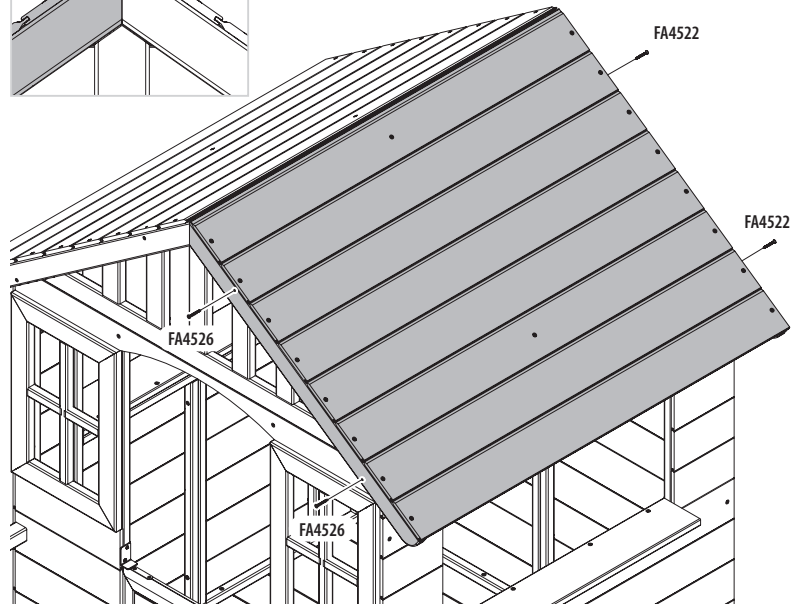
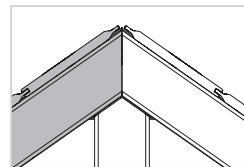

20

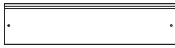

MW9319-WHT x16



MW9275-WHT x4



FA4535 - 3.5 x 20mm x32

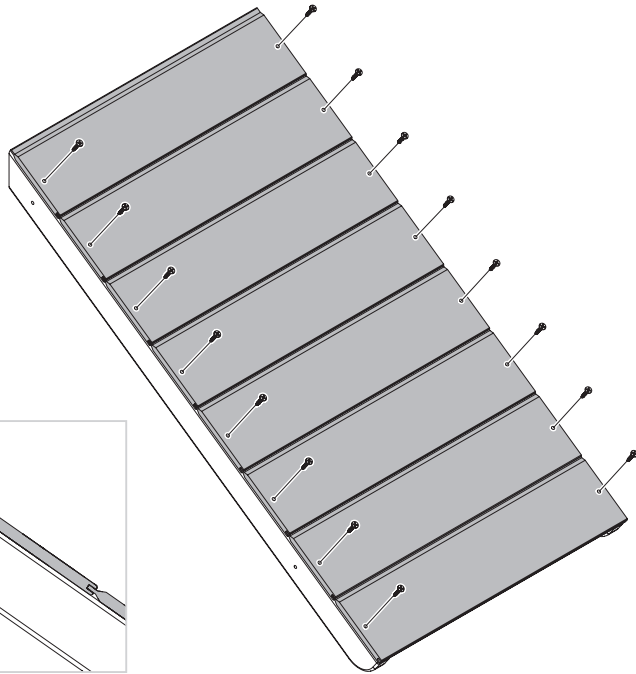
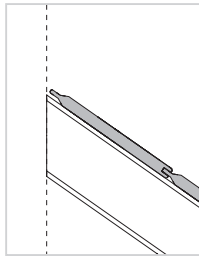

x2

21



FA4522 - 3.5 x 40mm x4

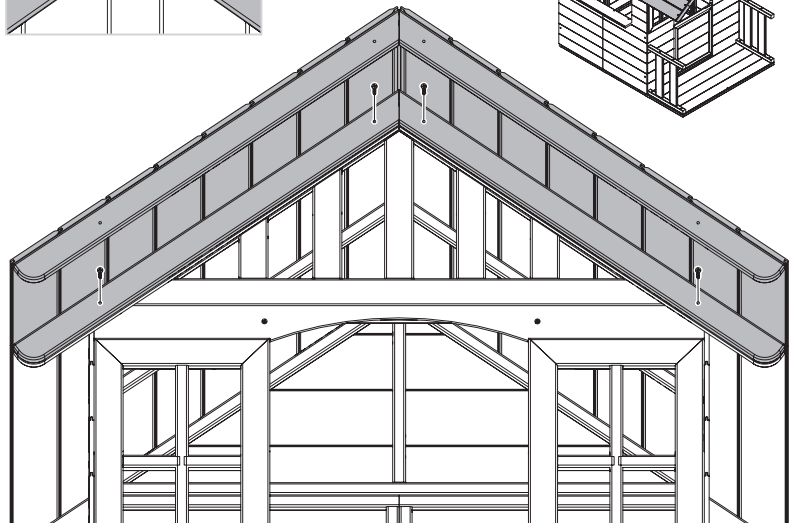
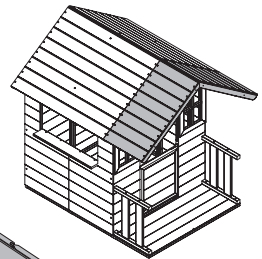
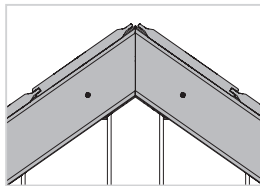

22



MW2113-WHT **x1**



FA4525 - 3.5 x 35mm **x2**

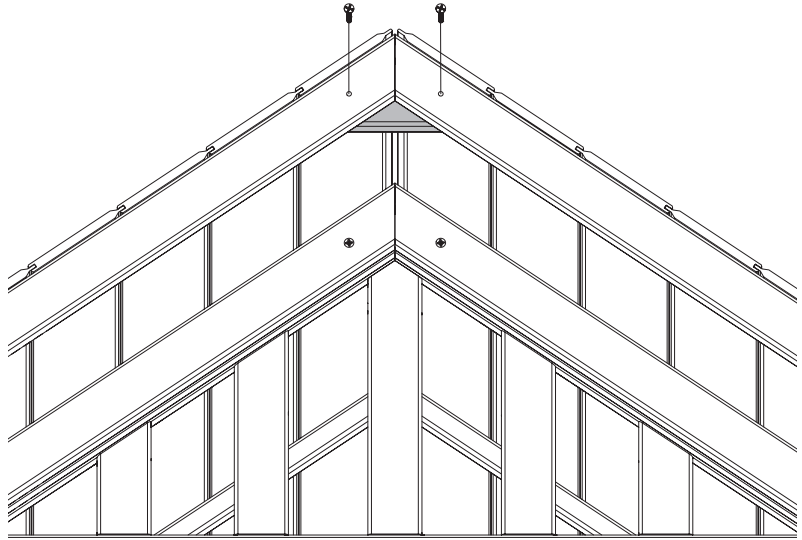

23



MW2217-WHT **x1**



MW9340-WHT **x1**



FA4525 - 3.5 x 50mm **x6**

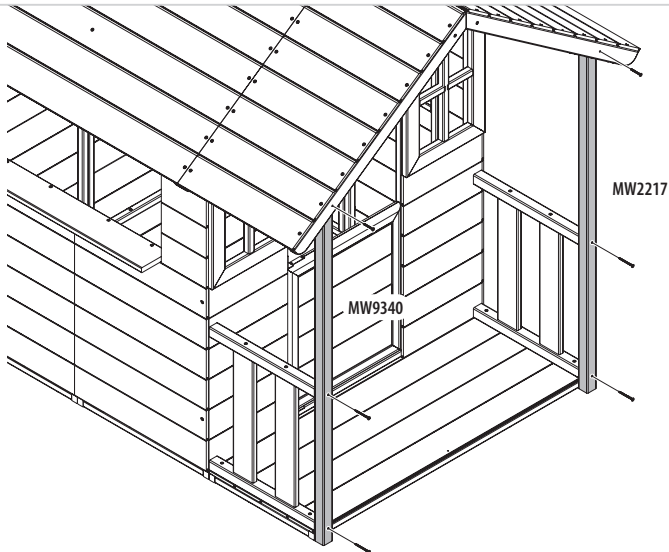

24



MW2116 **x1**



FA4526 - 3.5 x 30mm **x3**

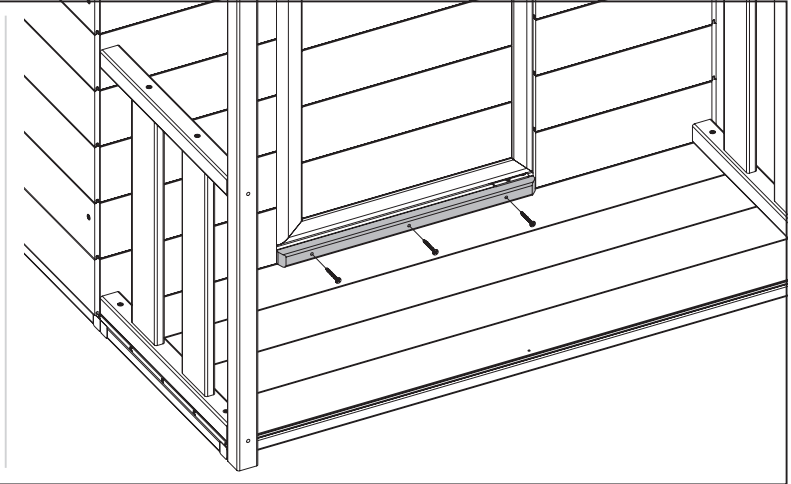

25

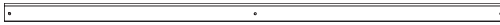

MW9290 **x2**



MW9291 **x2**



PM1970 **x1**



FA4529 - 3.5 x 16mm **x10**

1

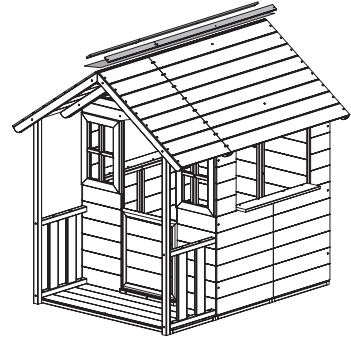
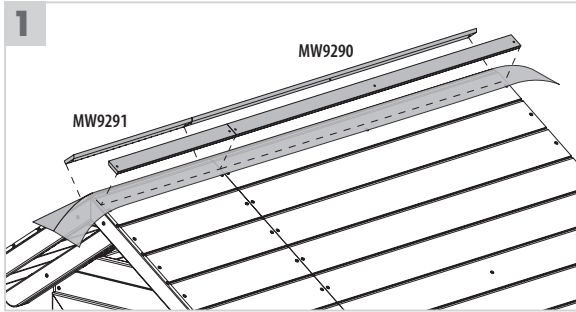

2

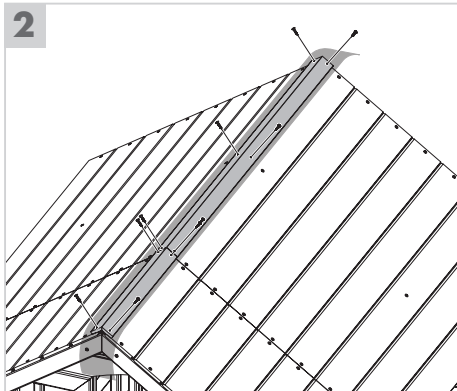

3



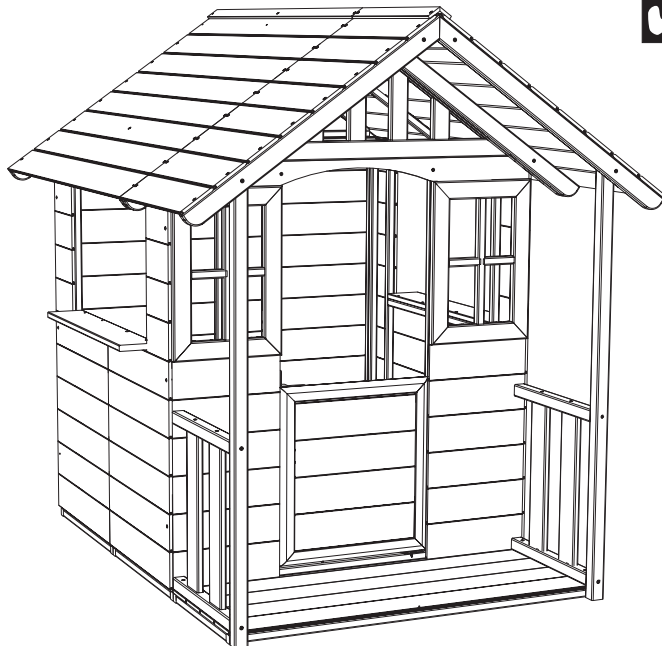

ZWERKULES

EN

Thank you!

Thank you for purchasing this product.

DE

Danke schön!

Vielen Dank für den Kauf dieses Produkts.

50NRTH GmbH

Straßburgstrasse 14-16, D-54516 Wittlich, Germany.

www.50NRTH.com

service@50NRTH.com

+49 (0) 6571 95 117-0

We reserve the right to alter the specification on this product without prior notice.
Wir behalten uns das Recht vor, die Spezifikation dieses Produkts ohne vorherige Ankündigung zu ändern.



RACCOLTA DIFFERENZIATA. VERIFICA LE DISPOSIZIONI DEL TUO COMUNE.



Fait référence au produit Adresses sur quefairedemesdechets.fr



Made in Latvia

ZW365_IN416Z/WA 02.25