

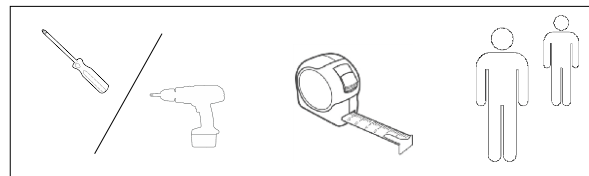





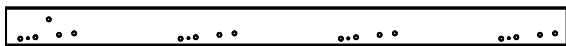

Before you start read carefully this assembly instruction

- Check the pack and make sure you have all the parts listed below. If not, please contact your local store who will be able to help you.
- When you are ready to start, make sure that you have the right tools to hand, plenty of space and a clean area for assembly.

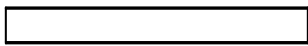
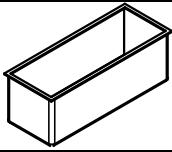

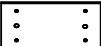
List of the components and fixings:

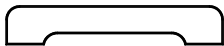
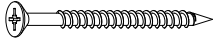
Ref.	Description	Illustration	Qty	Ref.	Description	Illustration	Qty
A	118x8x1,8cm		x 2	F1	8x35mm		x72
B	118x8x1,8cm		x 2	F2	8x25 mm		x 4
C	60,4x8x1,8cm		x16	G			x 4
				H	3,5x45 mm		x16
D	13x8x1,8cm		x 2	I	3,5x30mm		x8
E	40x7x1,8cm		x 2	J	4x90 mm		x 4

To assembly the product, please follow the steps below:

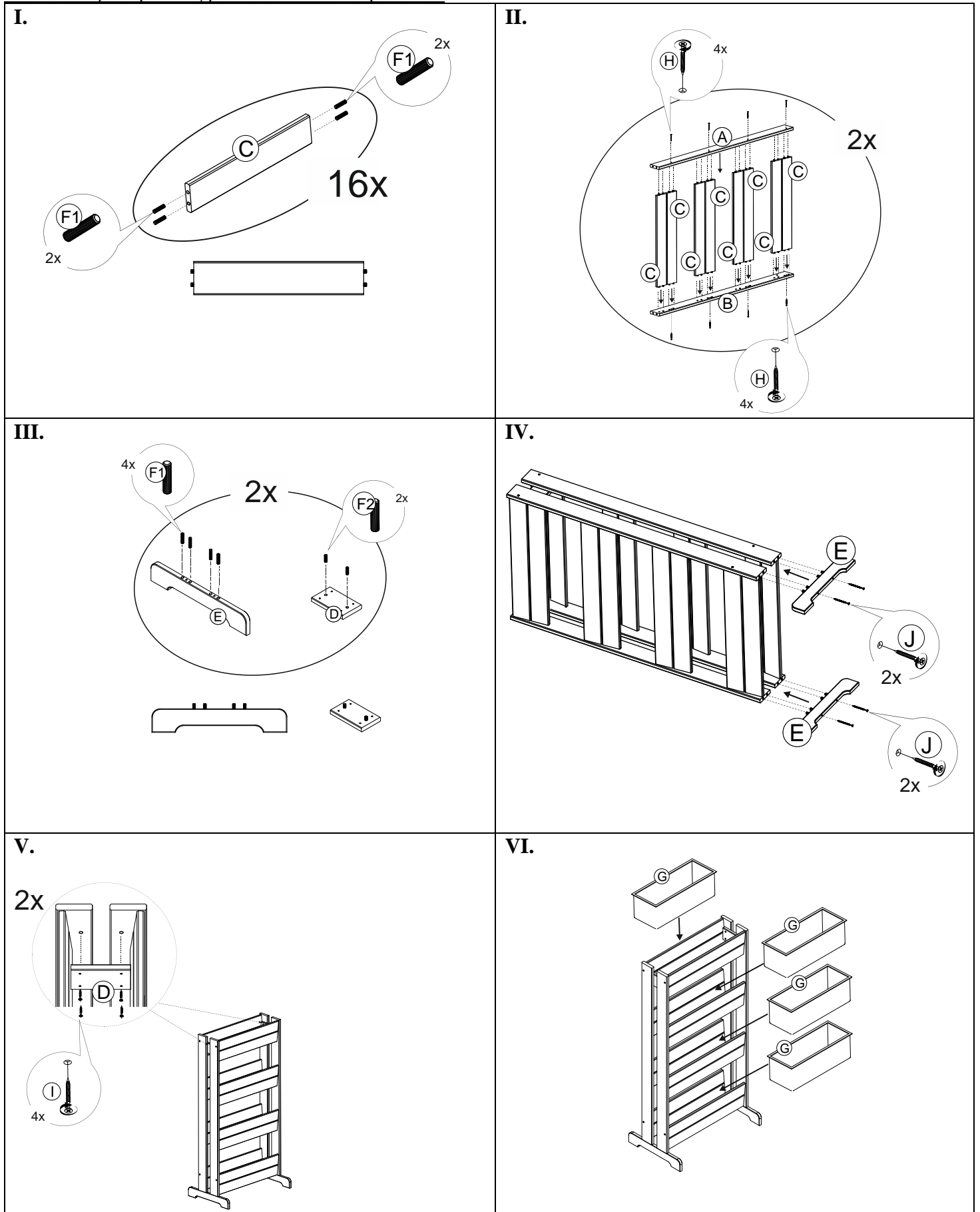

Care & Use

Please follow this care instruction in order to maintain the appearance and life of this product. Wood is a natural material, which will deteriorate when left outside exposed to the weather conditions.

A surface coating is vital in protecting it from premature darkening and splitting when exposed to the weather.

This finish should be regularly maintained to ensure that the wood is protected from moisture and the product continues to look its best. This product has been covered with non-chromic water-based preservative.

Maintenance

In order to maintain the appearance of the wood, regular coatings of a suitable water-based wood preservative should be applied. Should you choose to stop continuing treating your product, then it will fade and cracks can appear.