

Alex Mini
Art. Nr. 4416540
1/8

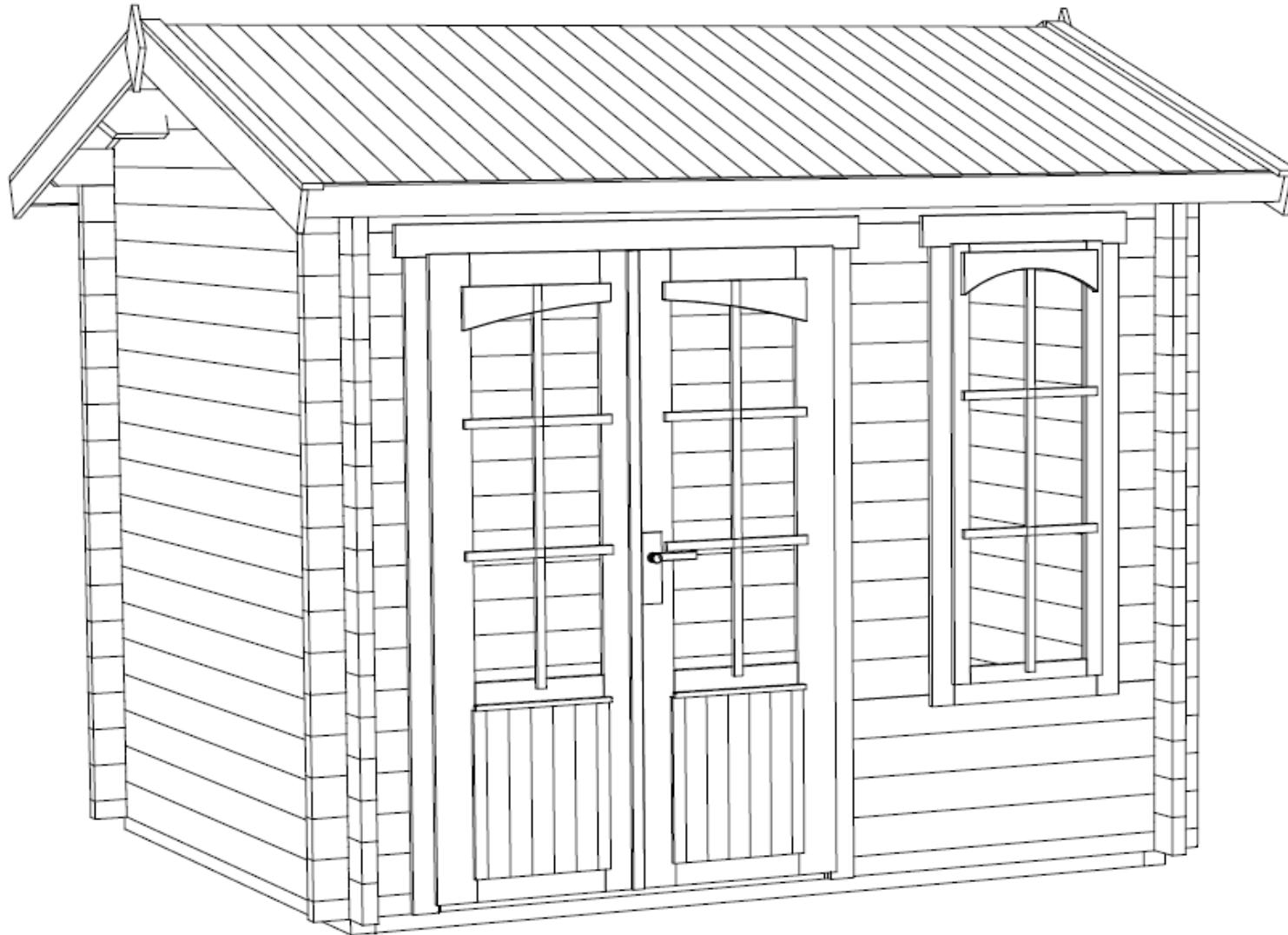

25.09.2014

Art. Nr. 4416540

GROUNDPLAN - GRUNDPLAN - PLAN DE MASSE

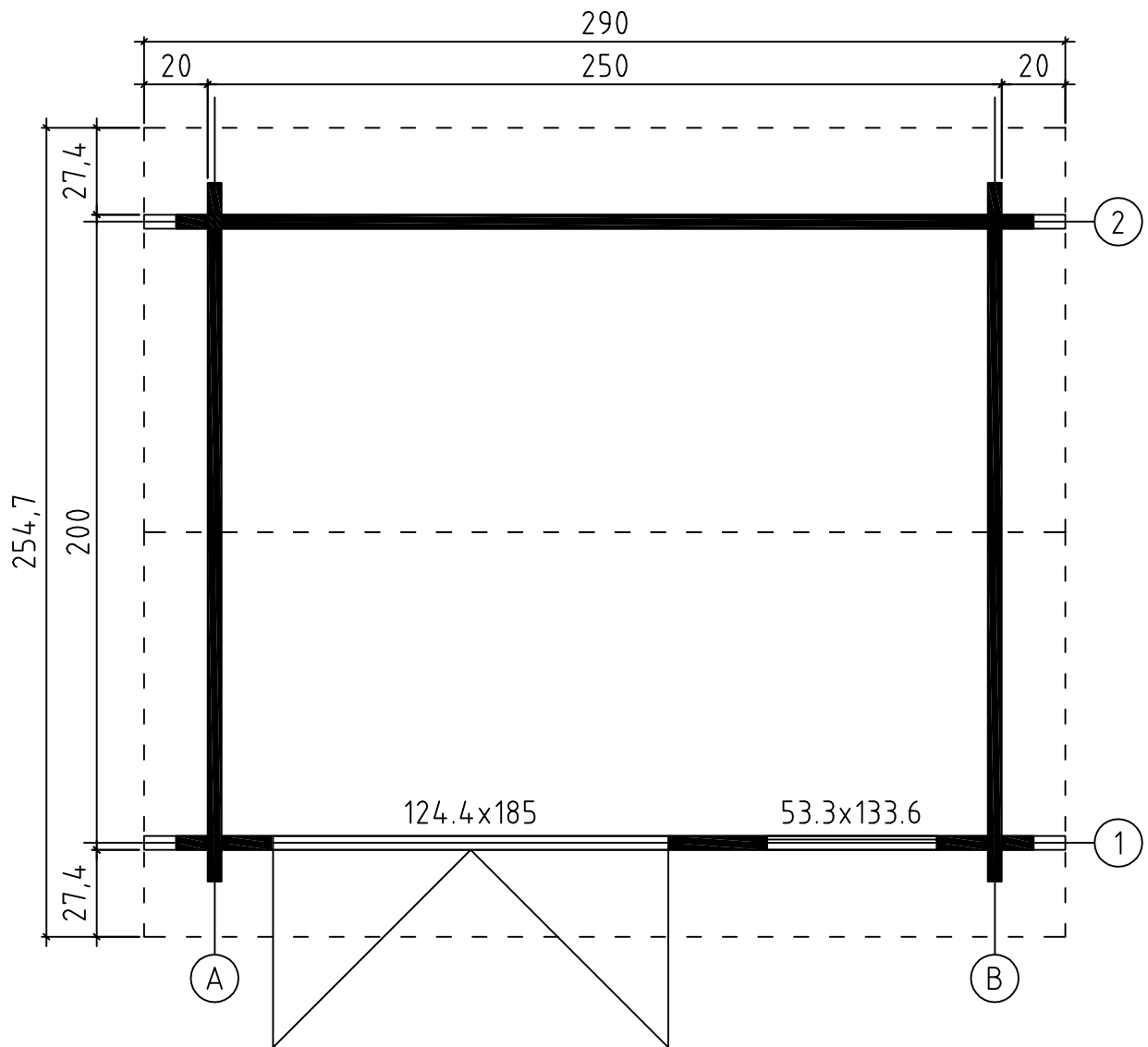

Art. Nr. 4416540

FOUNDATION - FUNDAMENT - FONDATION

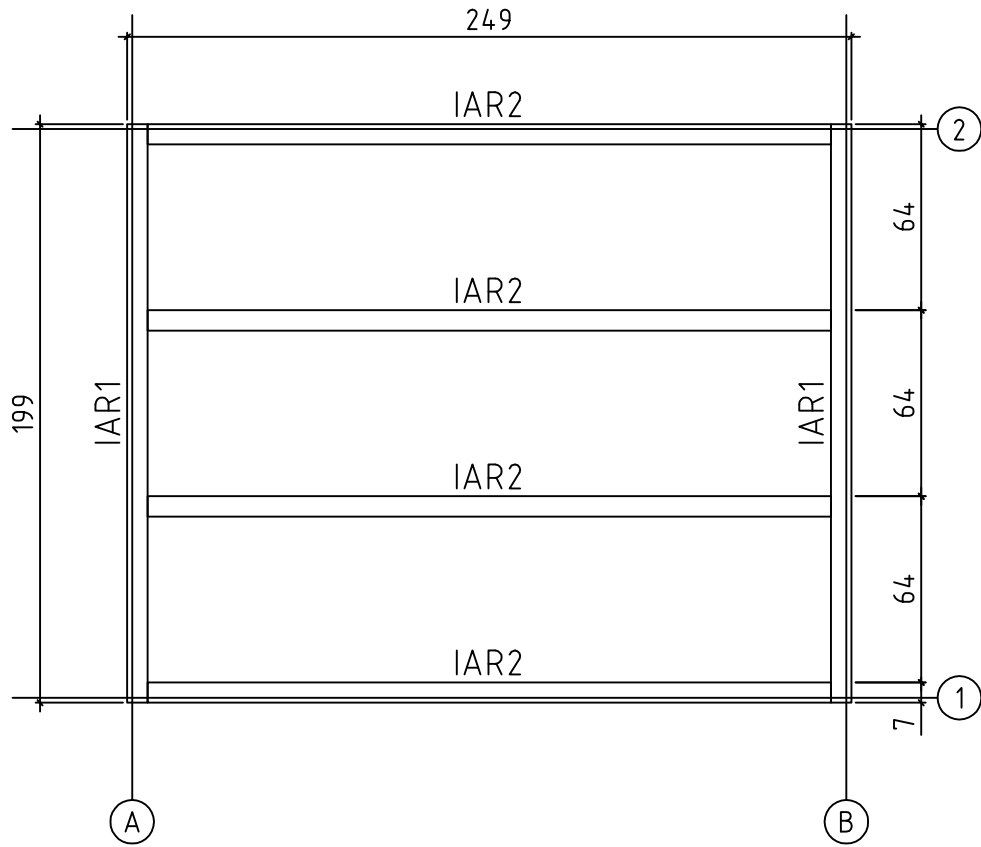

FLOOR BOARDS - FUSSBODENBRETTER - PLAN POSE PLANCHER

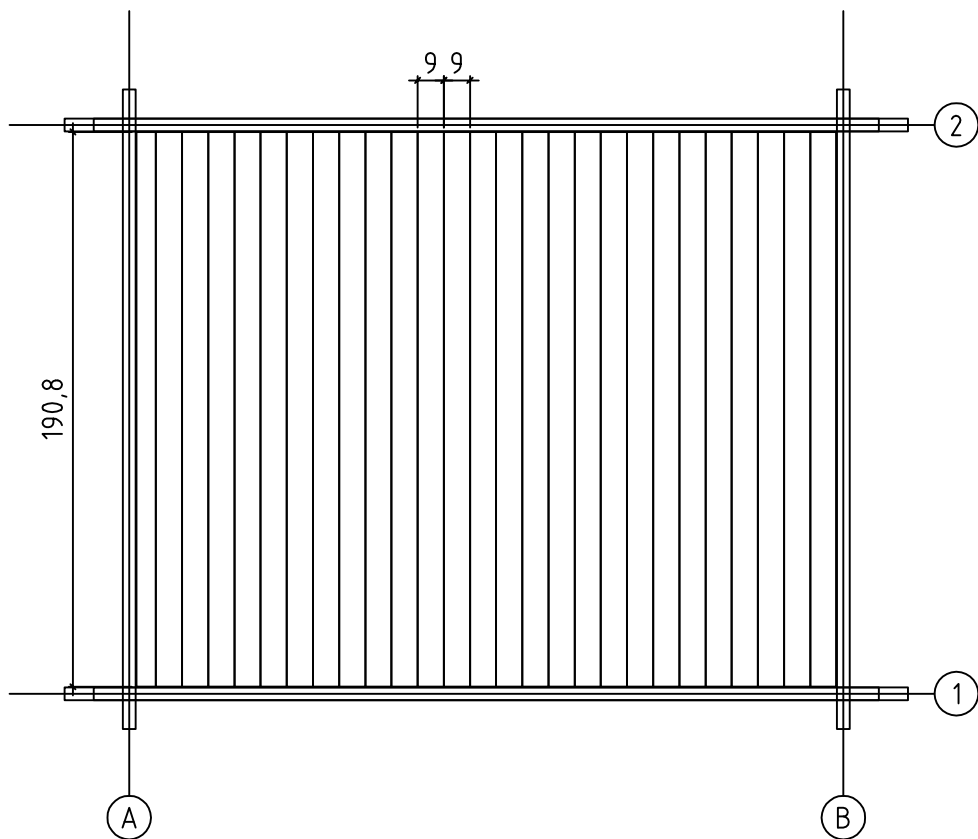



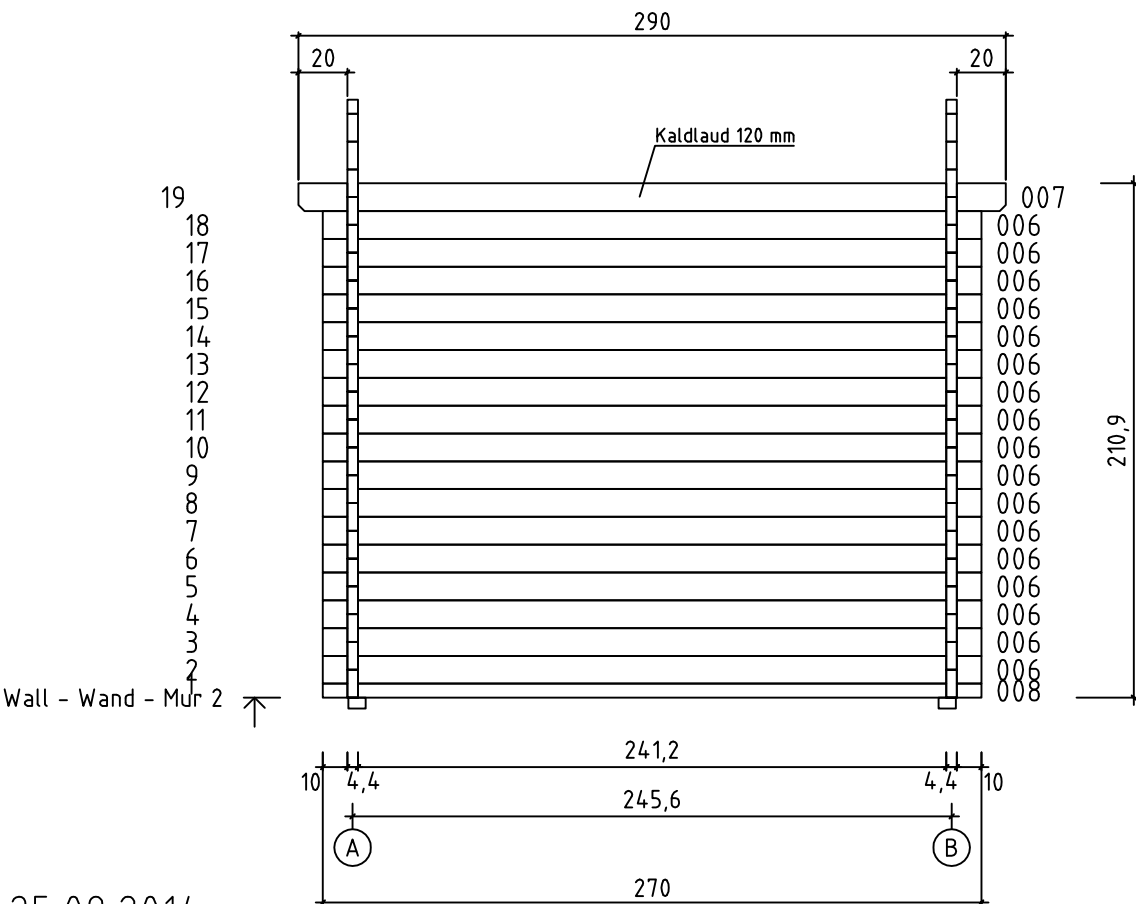
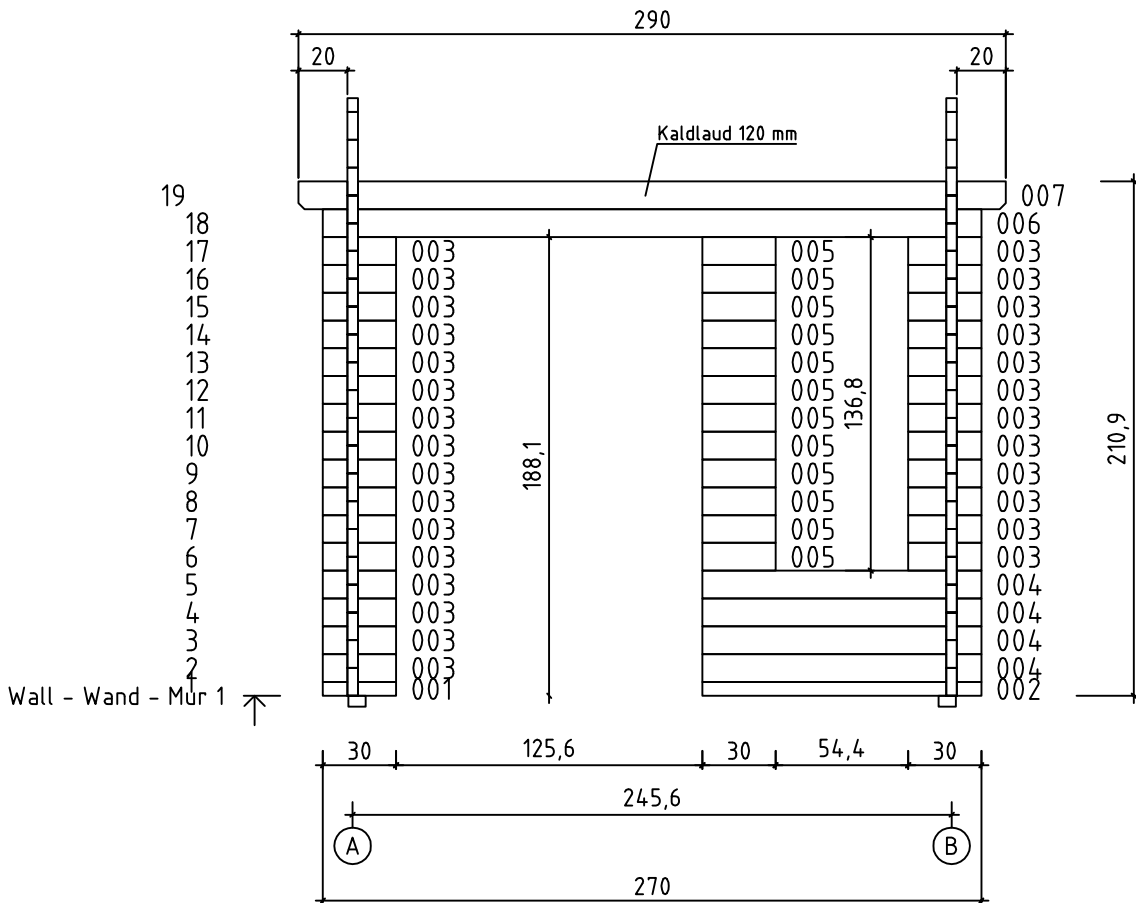



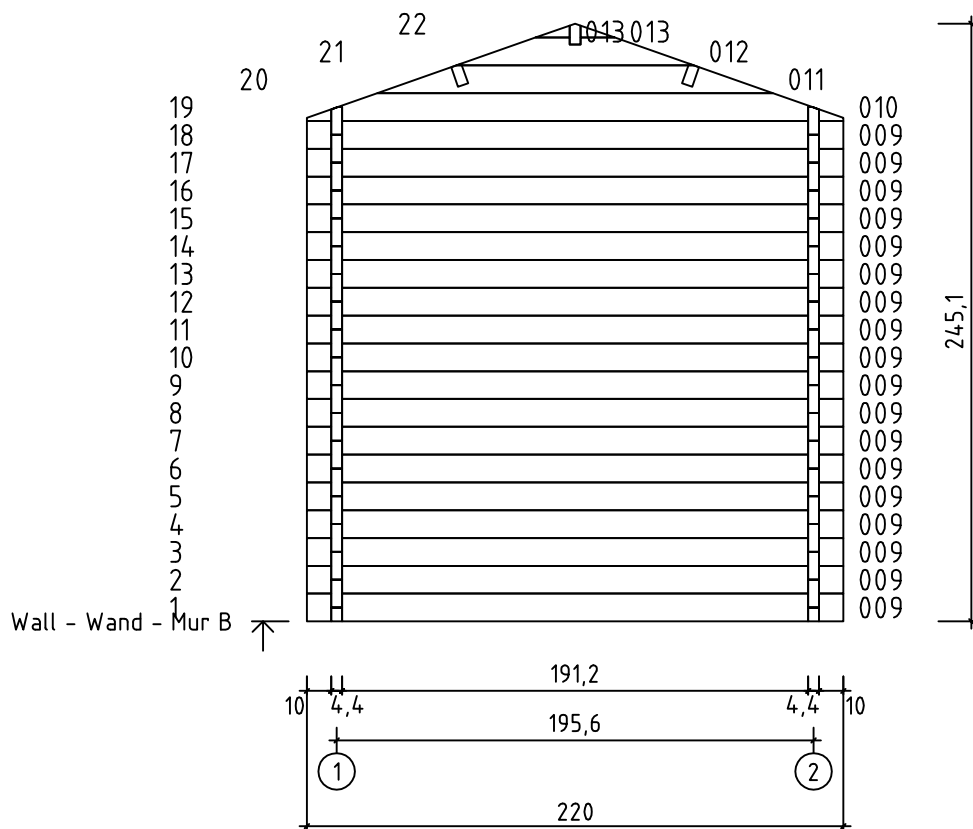
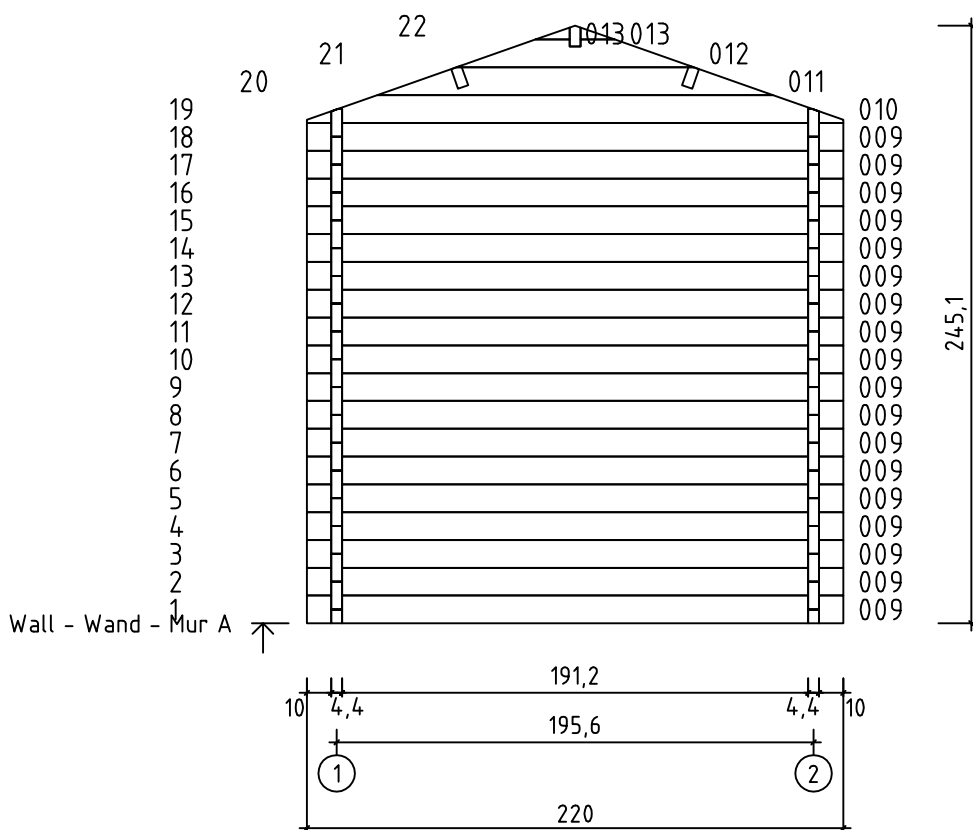

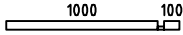

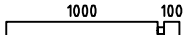

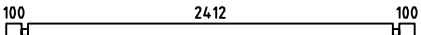
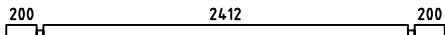
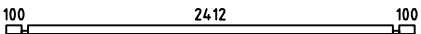
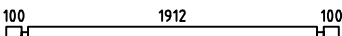
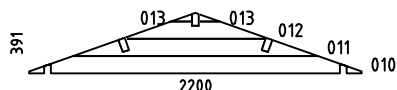
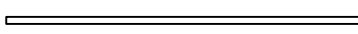
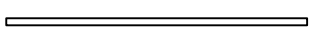
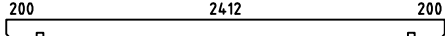
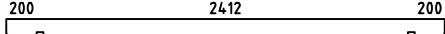



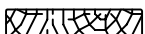

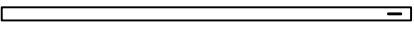
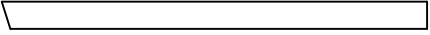
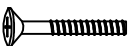
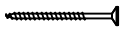

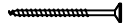
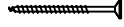
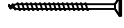
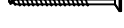



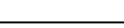
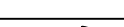

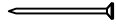
Art. Nr. 4416540

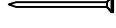

Art. Nr. 4416540

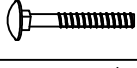

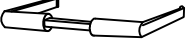
Pos	25.09.2014	Piecelist - Stücklist - Liste des composants Art. Nr. 4416540	6/8	Q.	P. (mm)	L. (mm)
001		100 156		1	44x57	300
002		1000 100		1	44x57	1144
003		156 100		28	44x114	300
004		1000 100		4	44x114	1144
005				12	44x114	300
006		100 2412 100		18	44x114	2700
007		200 2412 200		2	44x120	2900
008		100 2412 100		1	44x57	2700
009		100 1912 100		36	44x114	2200
WA-1 WB-1			1 1			
IAR2		FOUNDATION - FUNDAMENT - FONDATION		4	70x45	2350
IAR1		FOUNDATION - FUNDAMENT - FONDATION		2	70x45	1990
PR1		ROOF BEAM - DACHBALKEN - PANNE DE TOIT		1	44x140	2900
A-PR1		ROOF BEAM - DACHBALKEN - PANNE DE TOIT		2	44x140	2900
	FLOOR BOARDS - FUSSBODENBRETT - LAME DE PLANCHER			27	90x18	1908
	ROOF BOARDS - DACHBRETT - VOLIGES			66	90x18	1350
	FLOOR FILLET - FUSSBODENLEISTE - CORNIERE DE FINITION DU PLANCHER				18x18	8.63
	ROOFING FELT FILLET - DACHPAPPENLEISTE - BAGUETTE DE FIXATION DU FEUTRE BITUMEUX			4	18x58	1400
	EAVES BOARD - TRAUFBRETT - BANDEAU DE TOIT			2	18x90	2900
	ROOF EDGE REINFORCEMENT - DACHRANDVERSTÄRKUNG - CORNIERE DE RENFORT DE BORD DE TOIT			2	28x34	2900
	STORM PROTECTION - STURMLEISTE - - LATTE ANTI-TEMPETE			4	22x45	2050
	GABLE MOULDING - GIEBELLEISTE - - PLANCHE DE RIVE			4	18x120	1400
	BOLT FOR WINDOW HANDLE FITTINGS - BOLZEN FÜR FENSTERGRIFF BESCHLAG - BOULON POUR POIGNÉE D'OUVERTURE DE FENETRE			4		
	SCREW FOR GEORGIAN BARS - SCHRAUBE FÜR SPROSSEN - VIS DE BARRES GEORGIANNE			28	2.5x20	

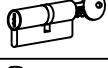
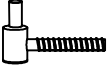
Pos	25.09.2014	Piecelist - Stücklist - Liste des composants Art. Nr. 4416540	7/8	Q.	P. (mm)	L. (mm)
		SCREW FOR GABLE SEGMENT - SCHRAUBEN FÜR DECKBLATT - VIS POUR FIXATION LOSANGE DE FINITION		4	3.5x35	
		SCREW FOR GABLE MOULDING - SCHRAUBEN FÜR GIEBELLEISTE - VIS DE FIXATION POUR PLANCHE DE RIVE		24	3.5x50	
		SCREW FOR DOOR FILLET - SCHRAUBE ZUR BEFESTIGUNG TÜRLEISTE - VIS D'ASSEMBLAGE DU CADRE DE PORTE		5	3x30	
		SCREW FOR EAVES BOARDS - SCHRAUBEN FÜR TRAUFBRETT - VIS DE FIXATION POUR BANDEAU DE TOIT		14	4x40	
		SCREW FOR ROOF EDGE REINFORCEMENT - SCHRAUBEN FÜR DACHRANDVERSTÄRKUNG - VIS POUR RENFORT DE BORD DE TOIT		14	4x40	
		SCREW FOR FOUNDATION - SCHRAUBEN ZUR BEFESTIGUNG FUNDAMENT - VIS DE FIXATIONS DES POUTRELLES DE FONDATIONS		8	5x120	
		SCREW FOR ROOF BEAMS - SCHRAUBEN FÜR DACHBALKEN - VIS POUR PANNE DE TOIT		10	5x120	
		SCREW FOR 1. WALL BEAM - SCHRAUBE FÜR 1. BOHLENREIHE - VIS DE FIXATIONS 1ère RANGÉE DE MADRIERS AVEC POUTRELLES DE FONDATIONS		6	5x90	
		SCREW FOR DOOR JAMB - SCHRAUBE FÜR TÜRRAHMEN - VIS DE FIXATION POUR MONTANT DE PORTE		4	5x90	
		SCREW FOR DOORSTEP - SCHRAUBEN FÜR SWELLE - VIS DE FIXATION DU SEUIL DE PORTE		3	4.5x65	
		WINDOW HANDLE FITTINGS - FENSTERGRIFF - POIGNÉE D'OUVERTURE DE FENETRE		2		
		ZN NAIL FOR FLOOR FILLET - ZN NÄGEL FÜR FUSSBODENLEISTE - POINTE POUR CORNIERE DE FINITION DU PLANCHER		17	1.4x40	
		HAMMER BLOCK - SCHLAGHOLZ - CALLE DE FRAPPE		1		
		NUT FOR STORM PROTECTION - SCHRAUBENMUTTER FÜR STURMLEISTE - ÉCROU POUR LAME ANTI-TEMPETE		8	D8	
		ZN NAIL FOR ROOF - ZN NÄGEL FÜR DACHBRETT - POINTES DE FIXATIONS DES VOLIGES DE TOIT		212	2x50	
		ZN NAIL FOR FLOOR - ZN NÄGEL FÜR FUSSBODENBRETT - CLOUS POUR PLANCHER		112	2x50	
		ZN NAIL FOR ROOFING FELT FILLET - ZN NÄGEL FÜR DACHPAPPENLEISTE - POINTE POUR BAGUETTE FIXATION FEUTRE BITUMEUX		16	2x40	
		BOLT FOR STORM PROTECTION - BOLZEN FÜR STURMLEISTE - VIS POUR LAME ANTI-TEMPETE		8	8x80	
		GABLE SEGMENT - DECKBLATT - LOSANGE DE FINITION		2		
		WASHER FOR STORM PROTECTION - DICHTSCHEIBE FÜR STURMLEISTE - RONDELLE POUR LAME ANTI-TEMPETE		8	D8	
		DOOR HANDLE FITTINGS - TÜRGRIF - SET DE GARNITURES DE SERRURE DE PORTE		1		
		SET OF DOOR LOCK COVERS - SCHLOSSBLENDEN - SET DE GARNITURES DE SERRURE DE PORTE		1		
		CYLINDER LOCK - ZYLINDERSCHLOSS - CYLINDRE DE SERRURE		1	30/35	
		MALE BOLT HINGE FOR DOOR - TÜRRIEGEL - PARTIE MALE DE CHARNIERE DE PORTE		6	16/52	

