

*Edinburgh 2*  
*Art. Nr. 407640*  
1/13



08.01.2018

Art.Nr. 407640

Groundplan - Grundplan - Plan de masse - Planimetria - Plattegrond - Põhiplaan

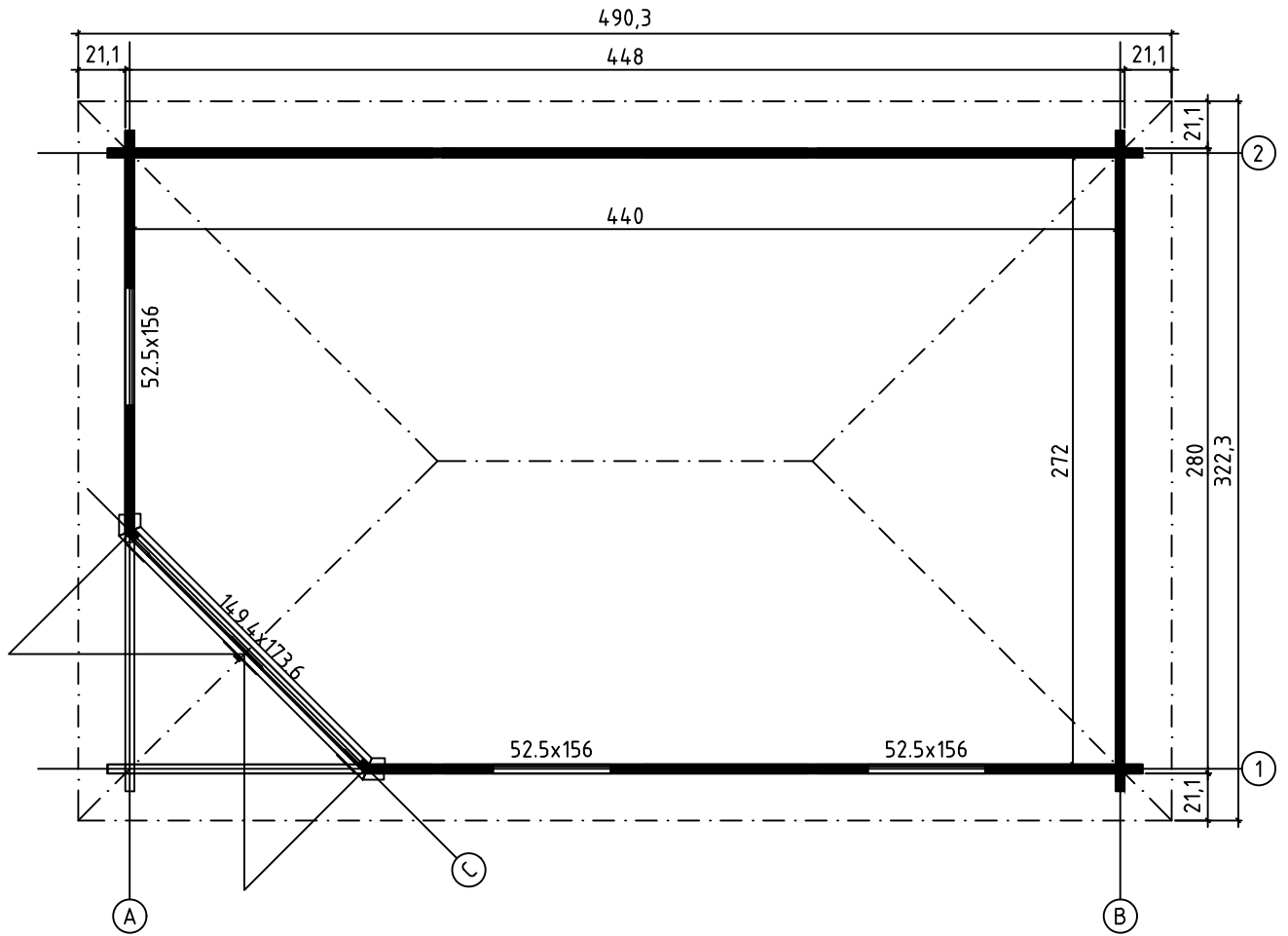

Foundation - Fundament - Fondation - Fondamenta - Fundering - Immutatud alusraam

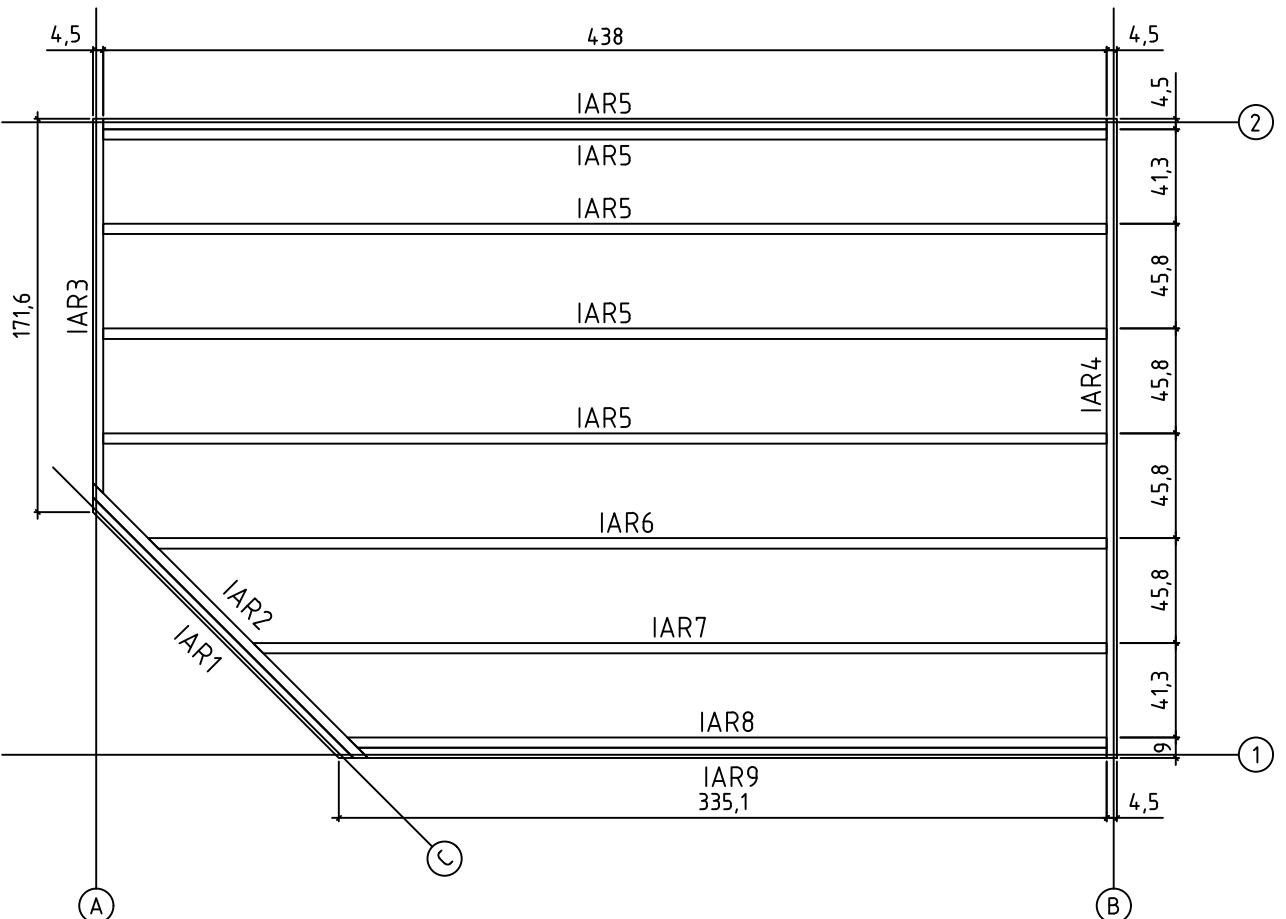

Art.Nr. 407640

Floor boards - Fussbodenbretter - Plan pose plancher -  
Pavimento - Vloerhout - Põrandalaudis

Mounting direction - Aufbauschritte - Instruction de montage -  
Direzione di montaggio - Beverstigungsrichtung - Monteerimise suund

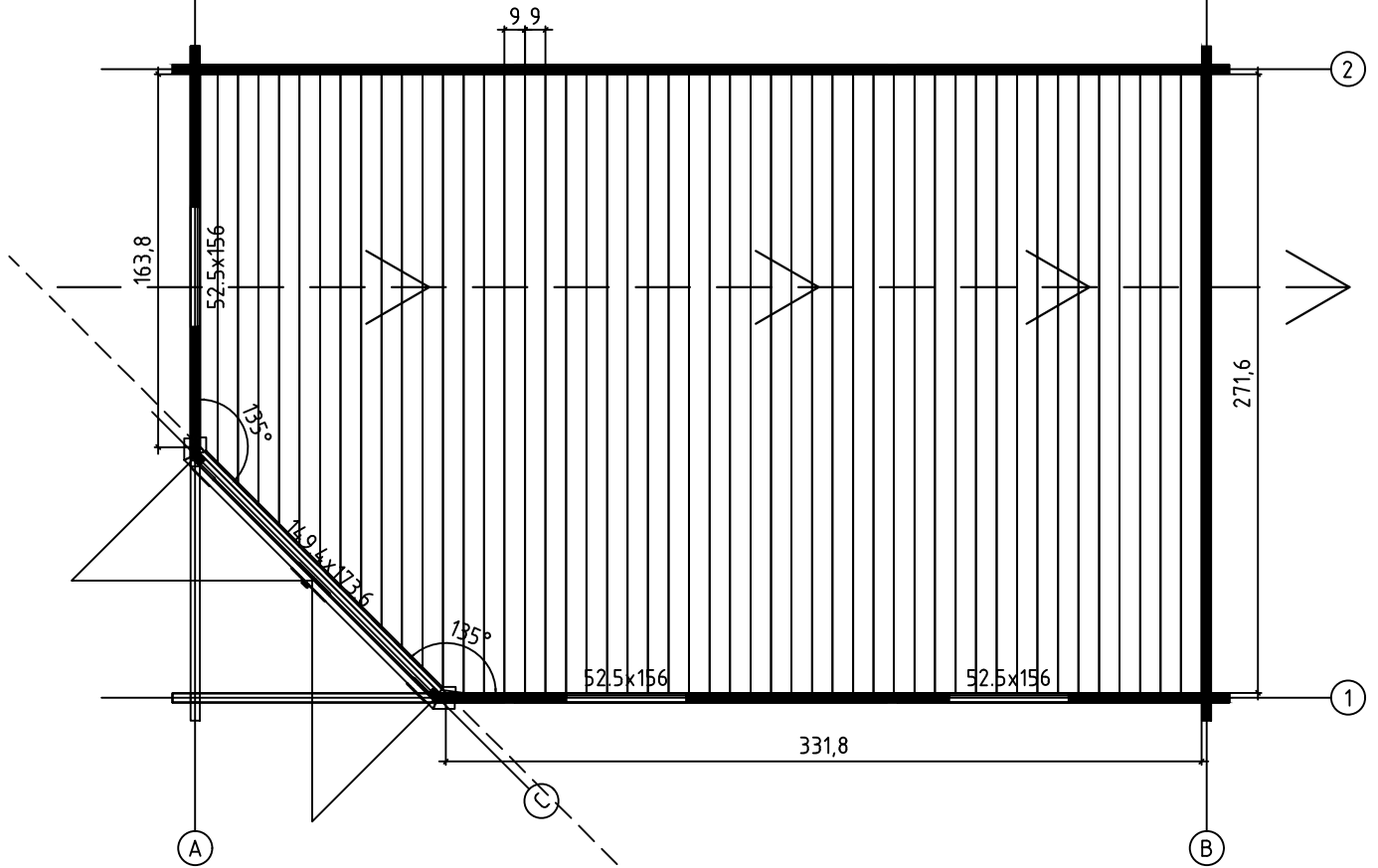

Overhead beams - Deckenbalken - Solives - Travi a vista -  
Overlopende balken - Laetalade konstruksioon

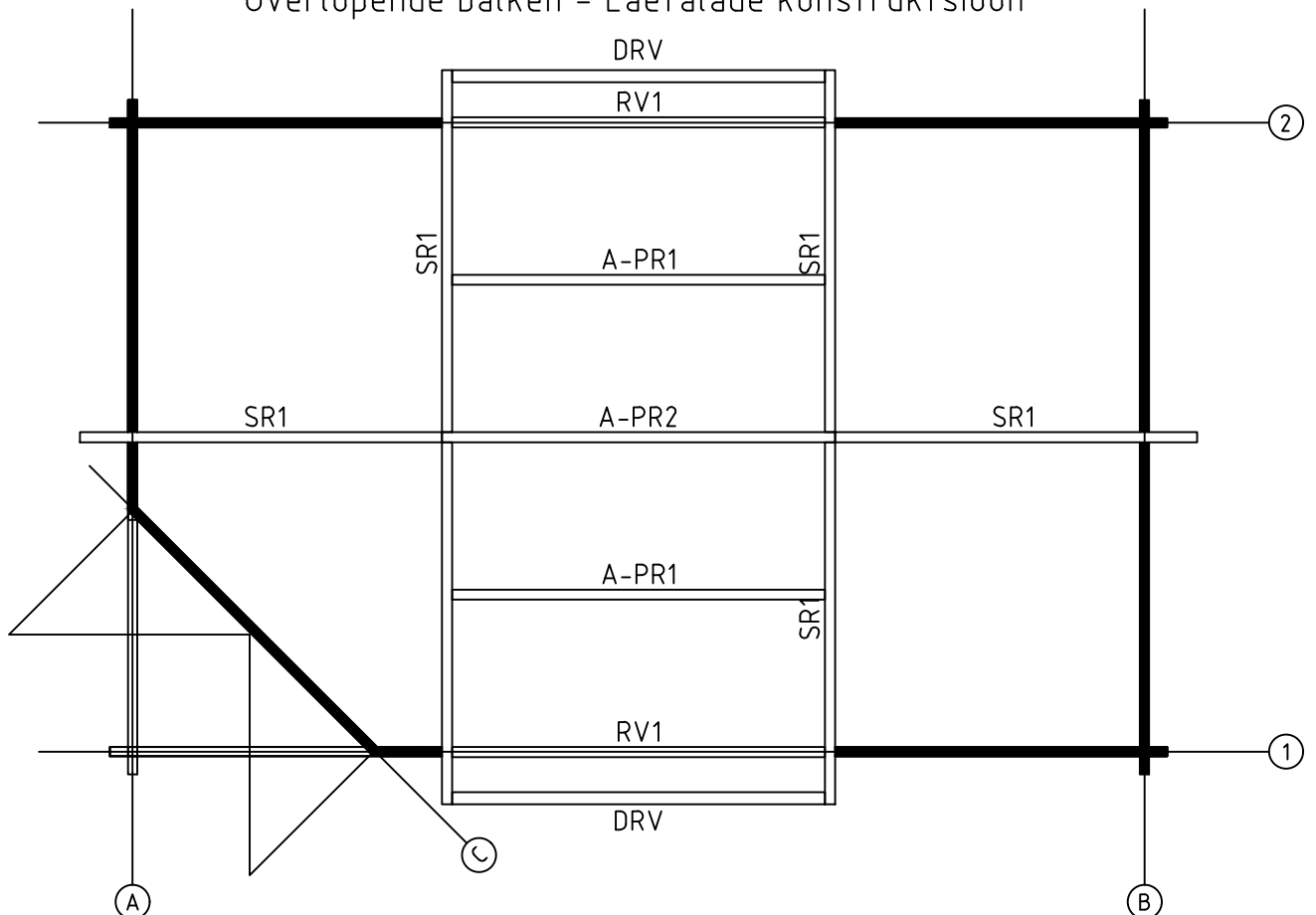

Art.Nr. 407640

Diagonals must be equal - Prüfung diagonale Austrichtug A=B -  
Controle des diagonales A=B - Le diagonali devono essere eguali -  
Gelijkbenige diagonaal - Diagonaalid peavad olema võrdsed A=B

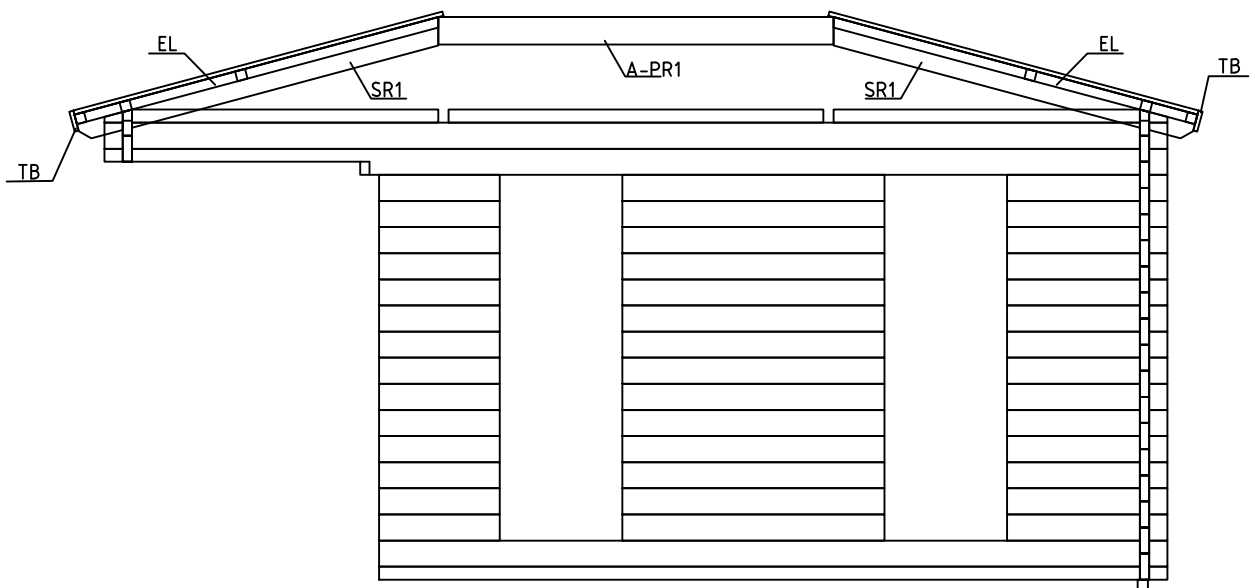
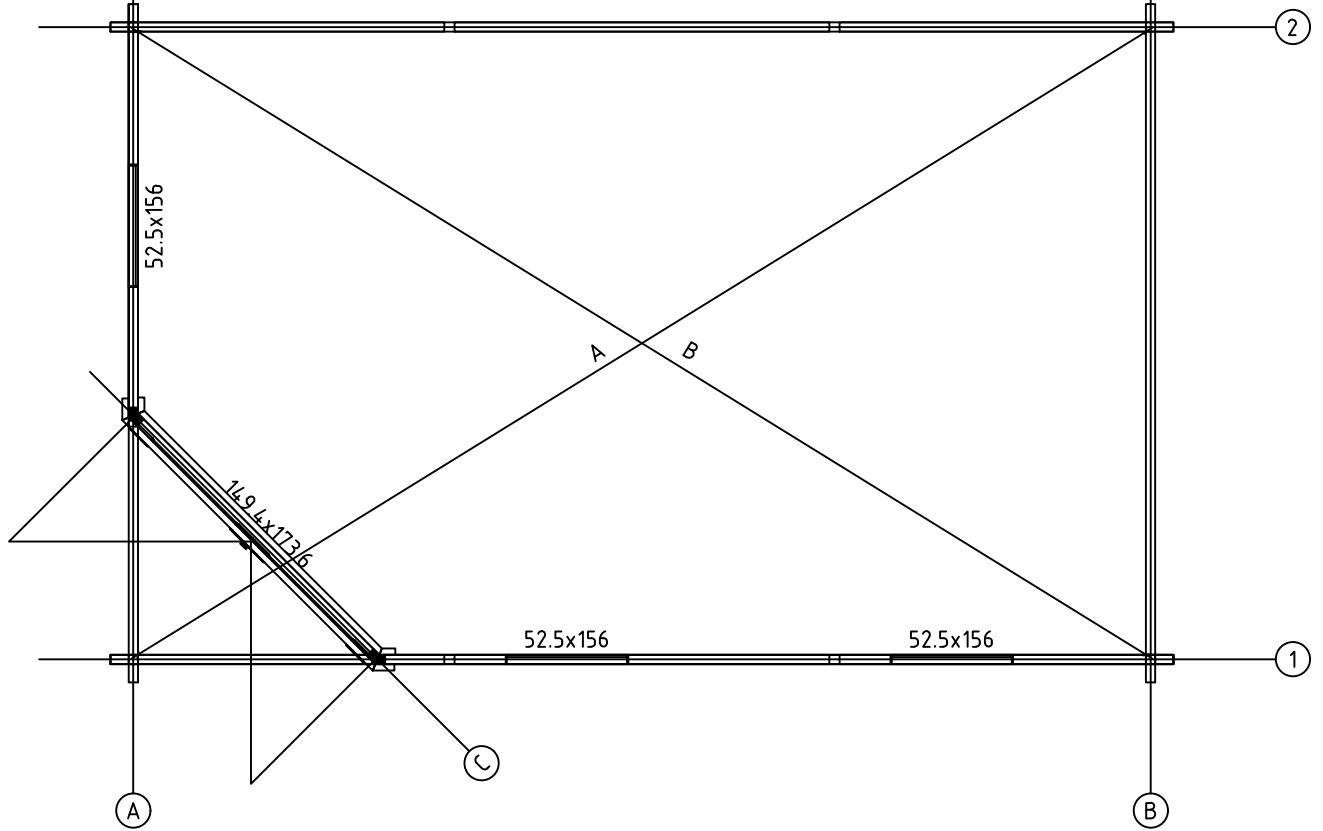

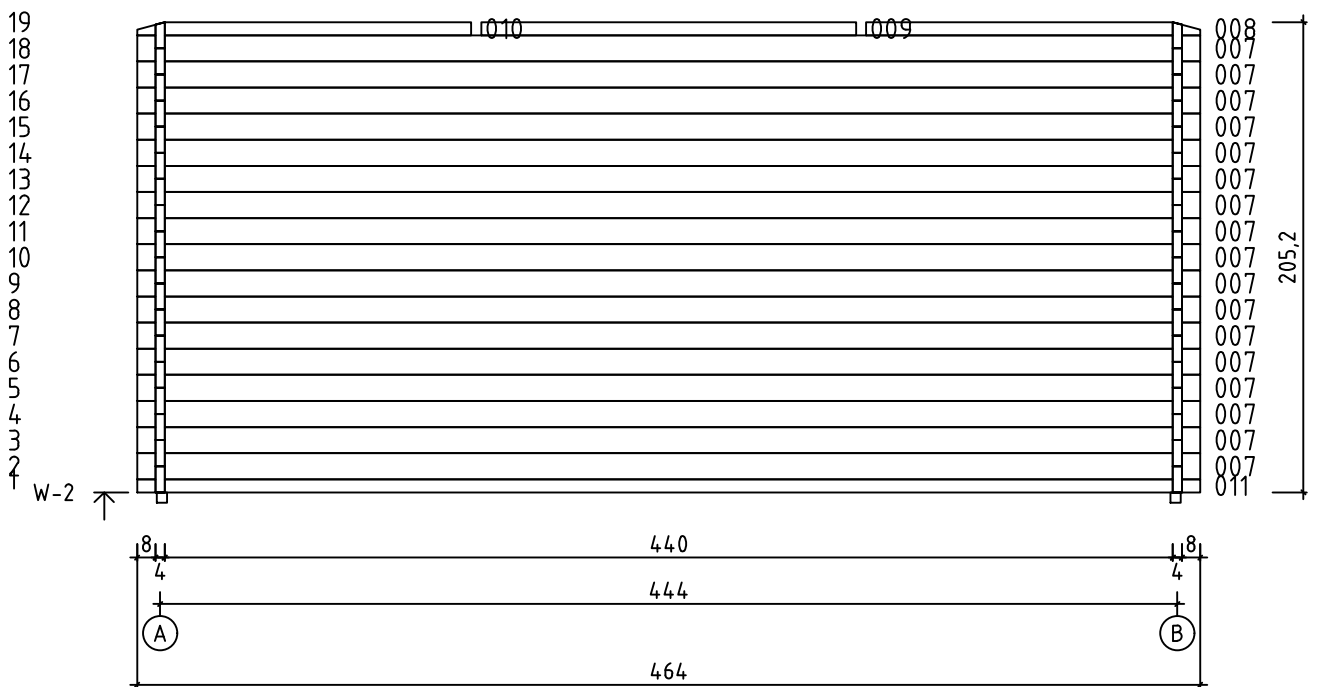
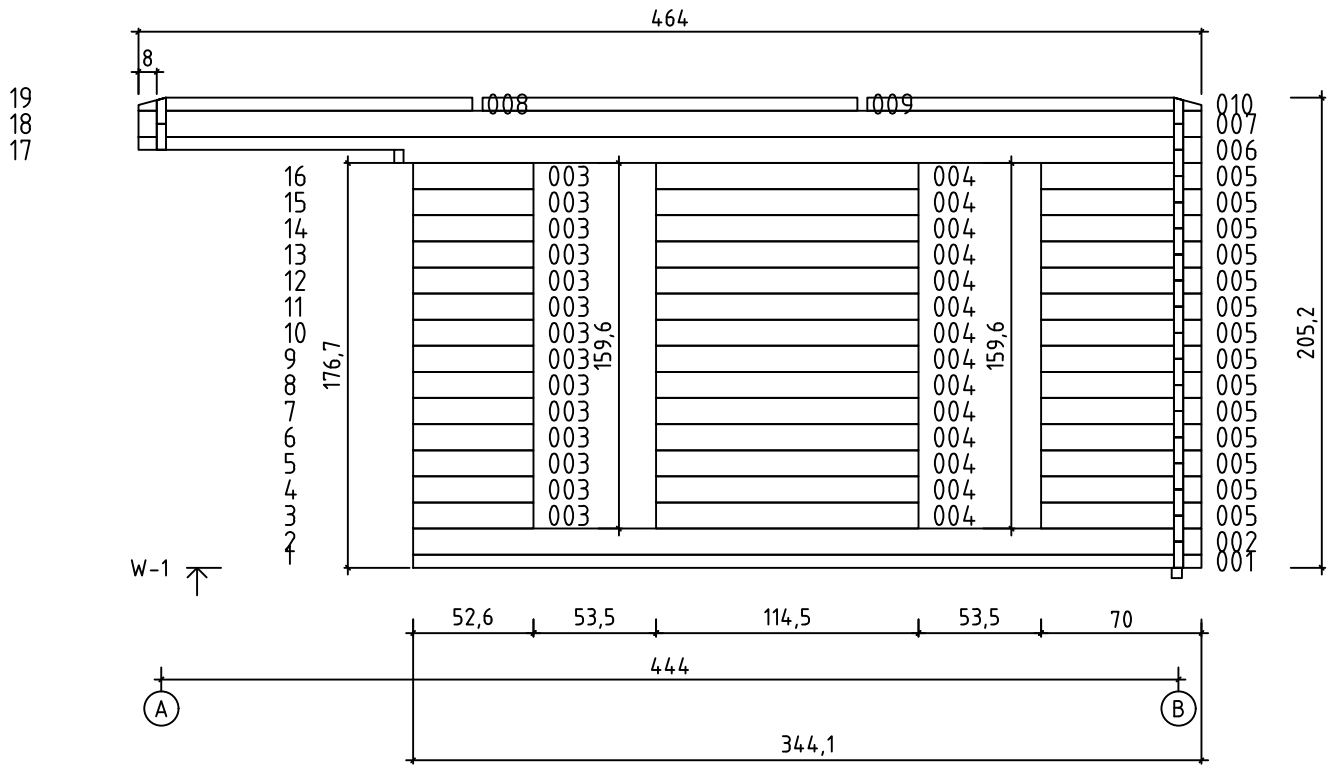

Art.Nr. 407640

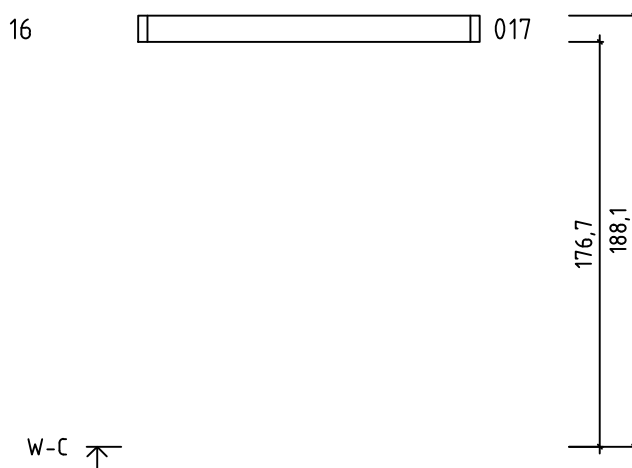
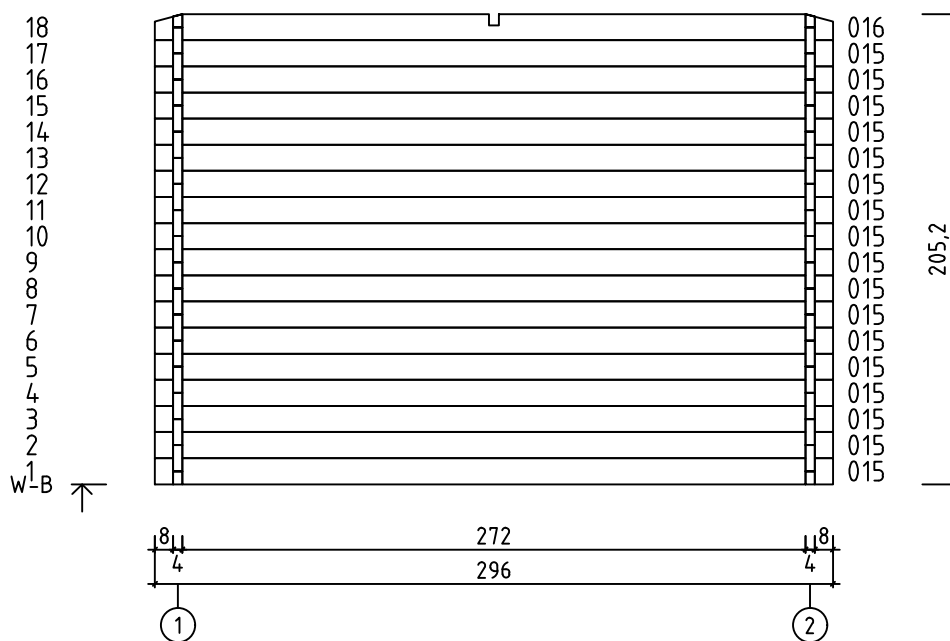
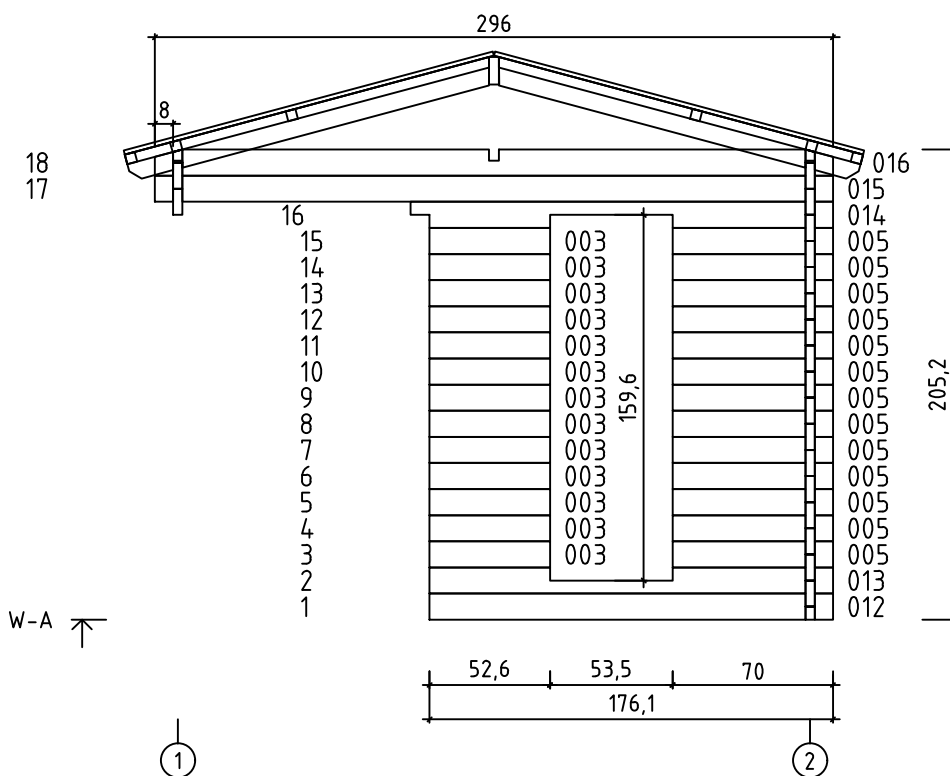

Art. Nr. 407640

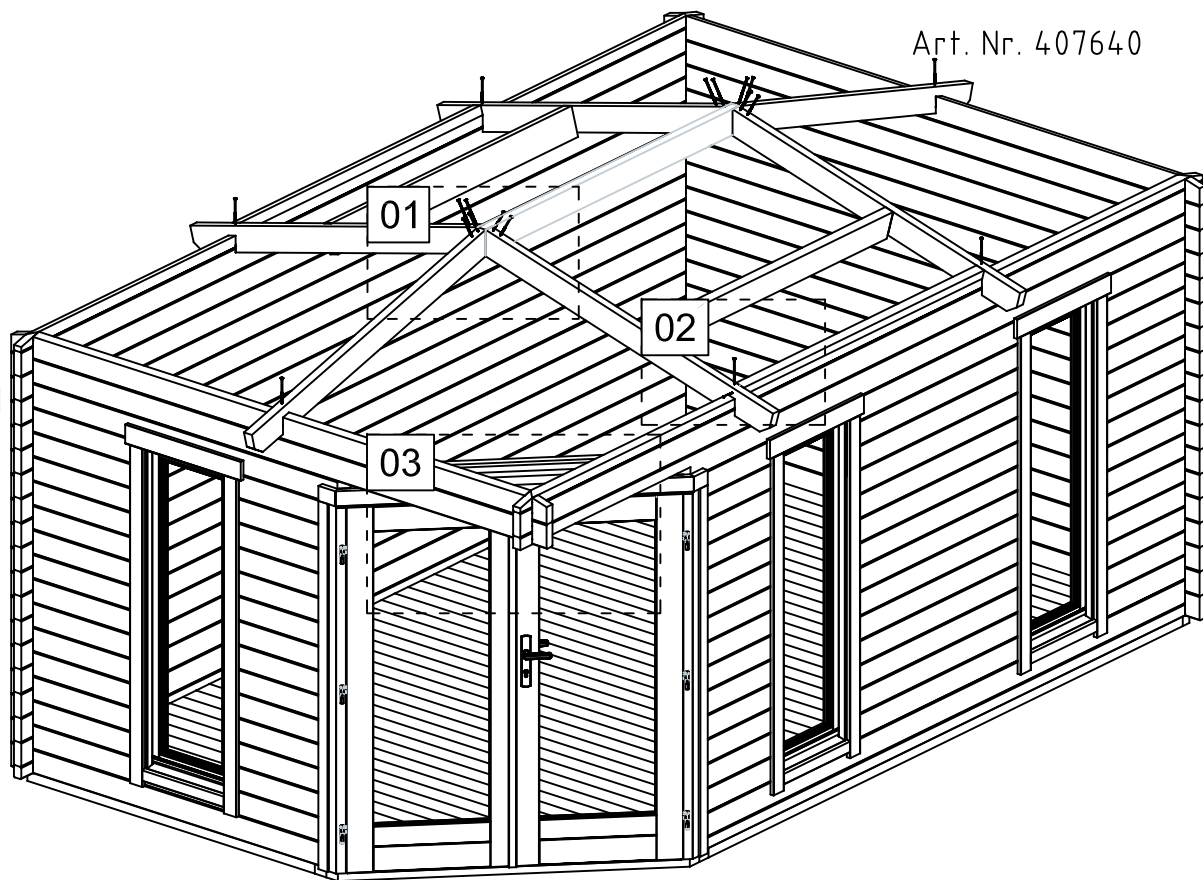

01

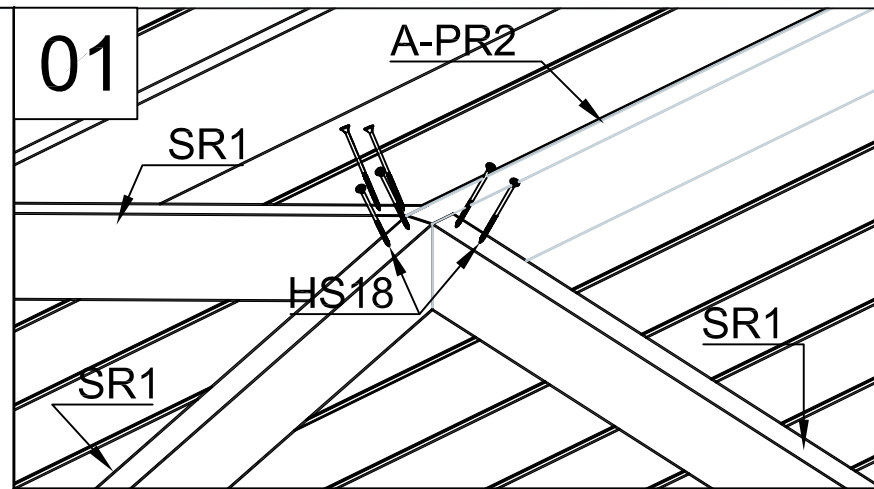

02

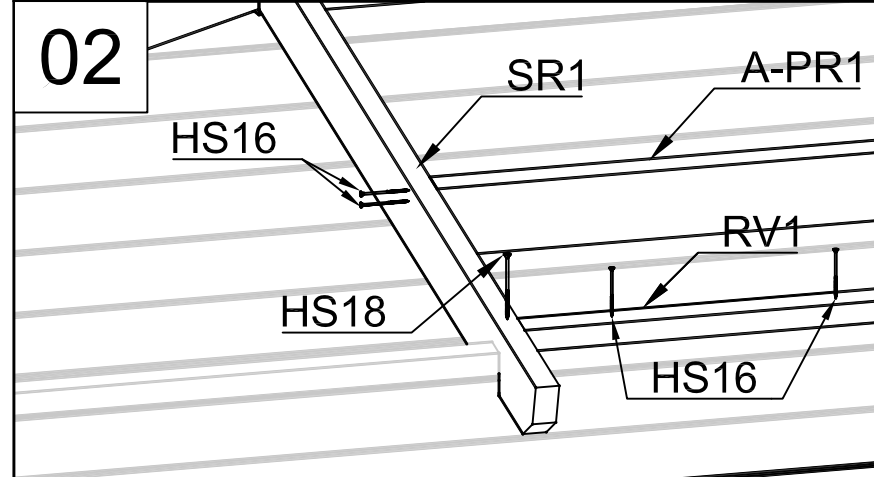

04

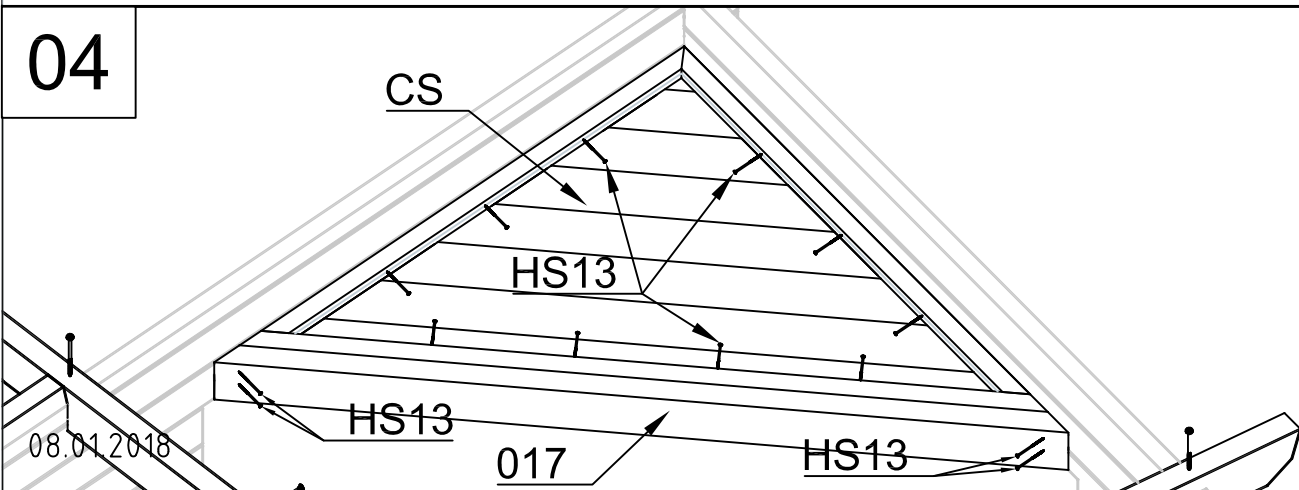

03

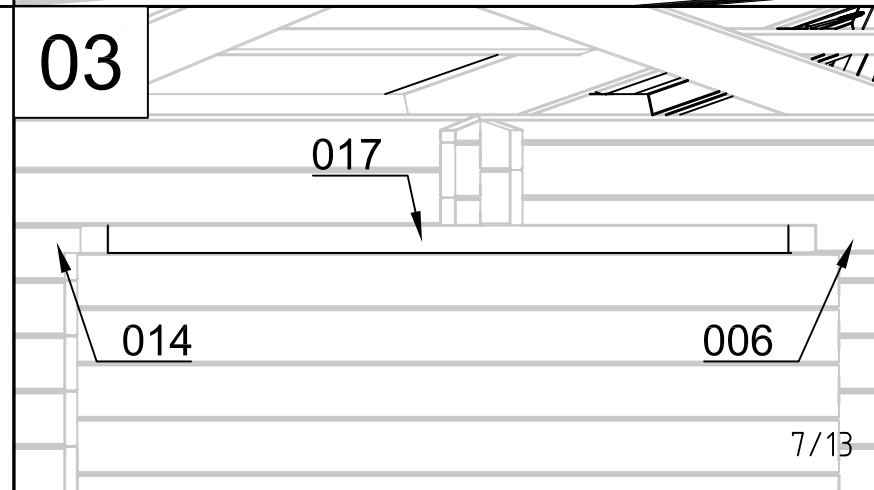

08.01.2018



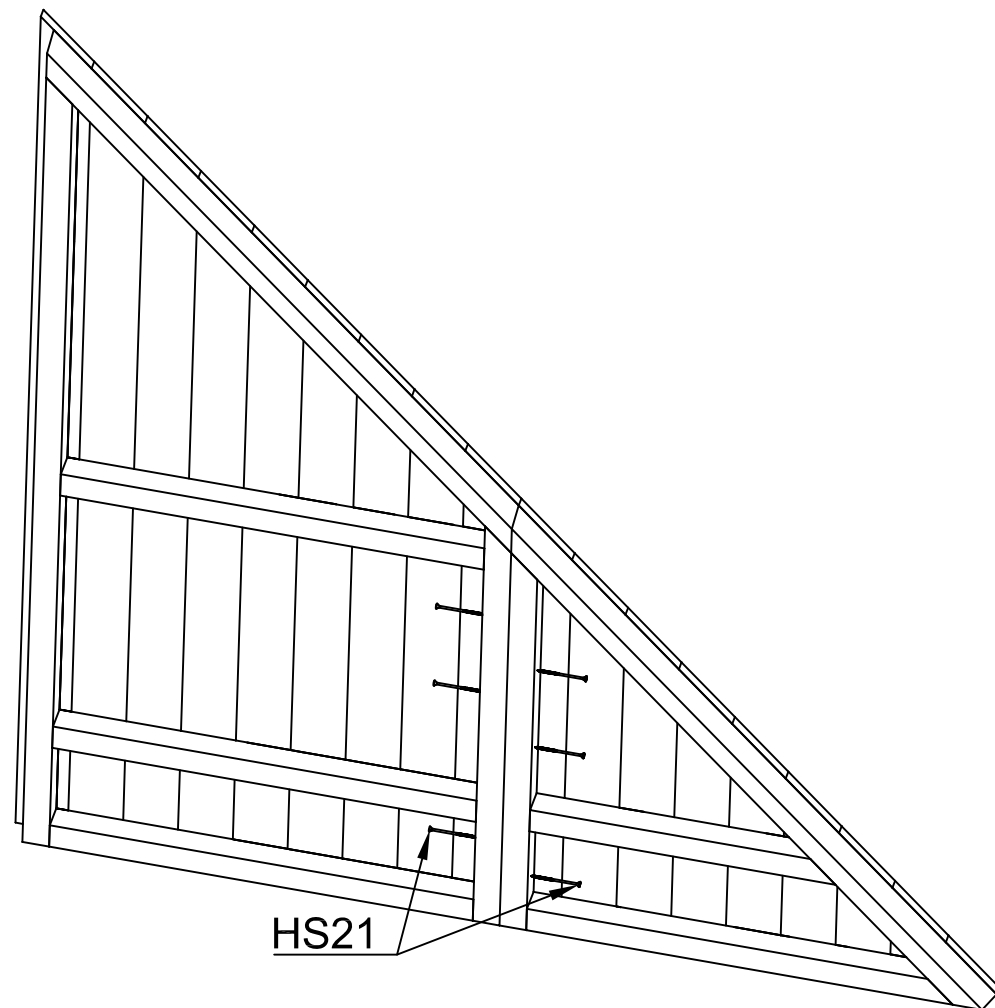
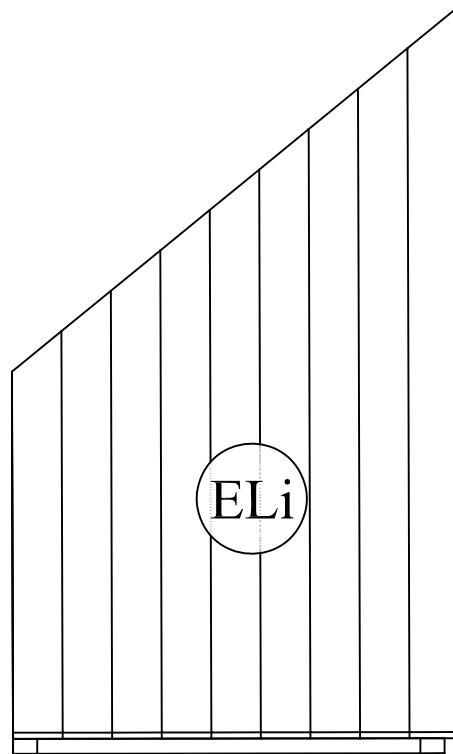
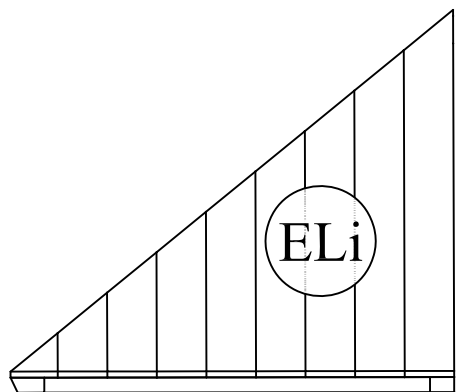

7/13

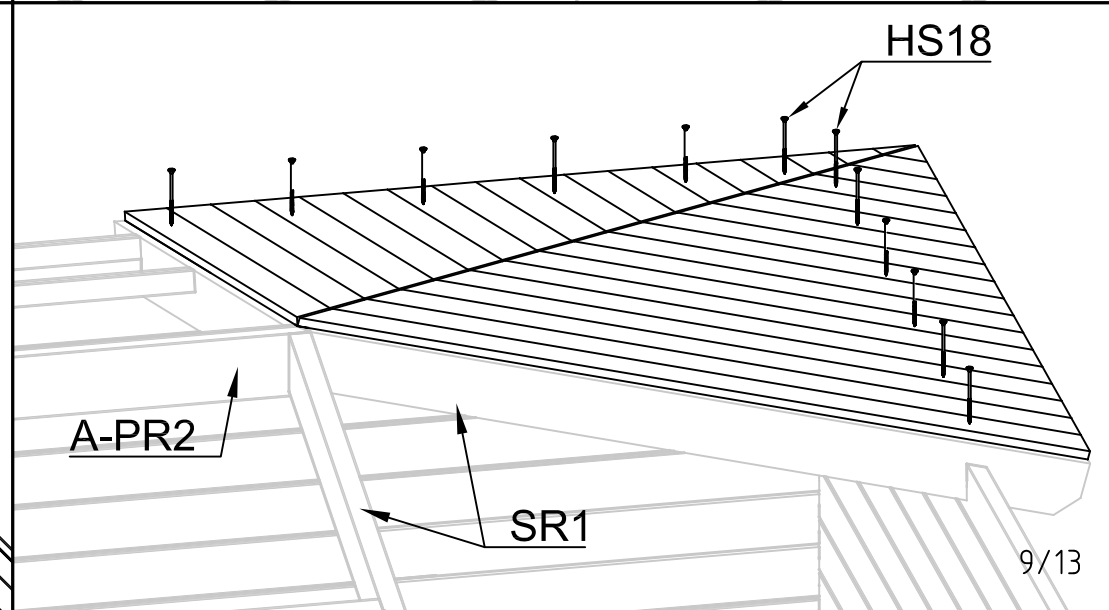
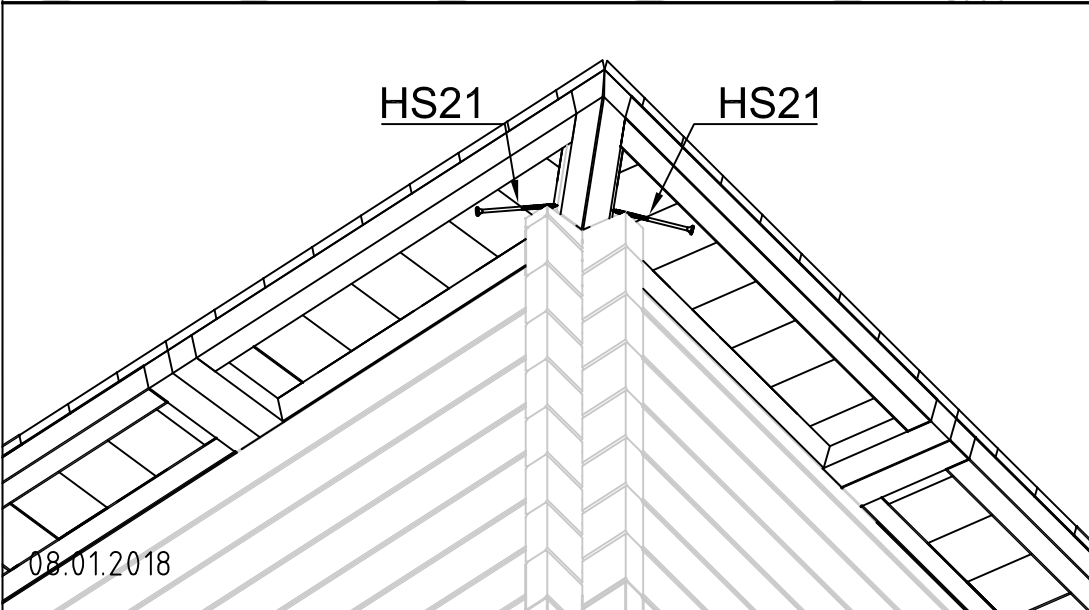
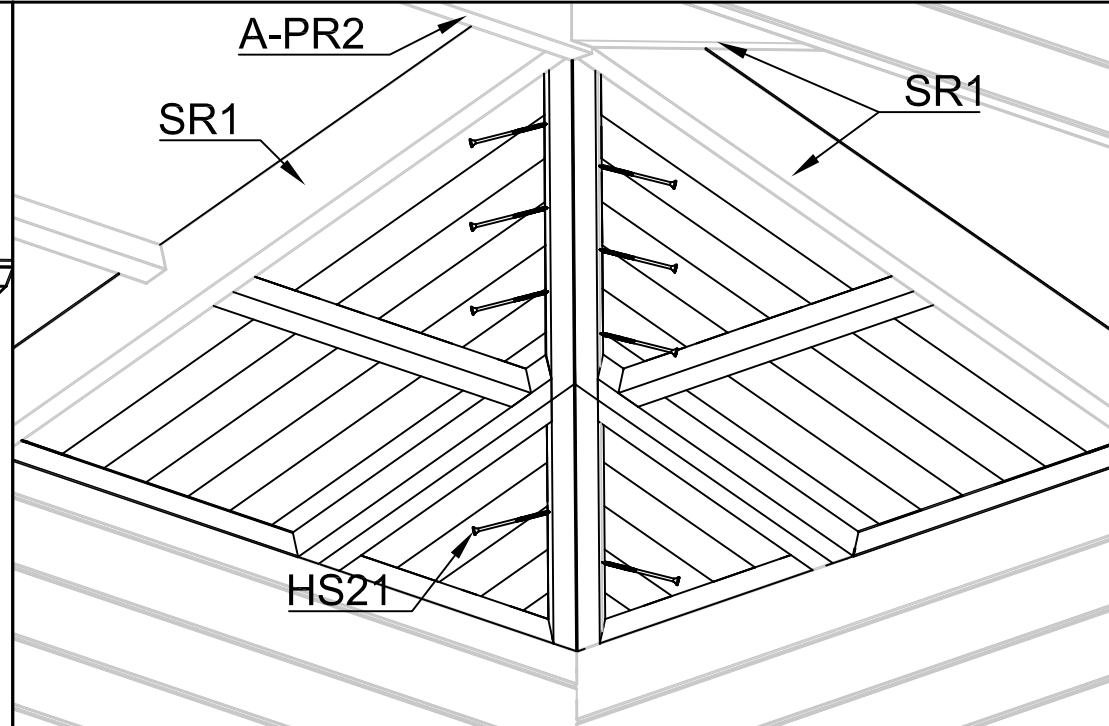
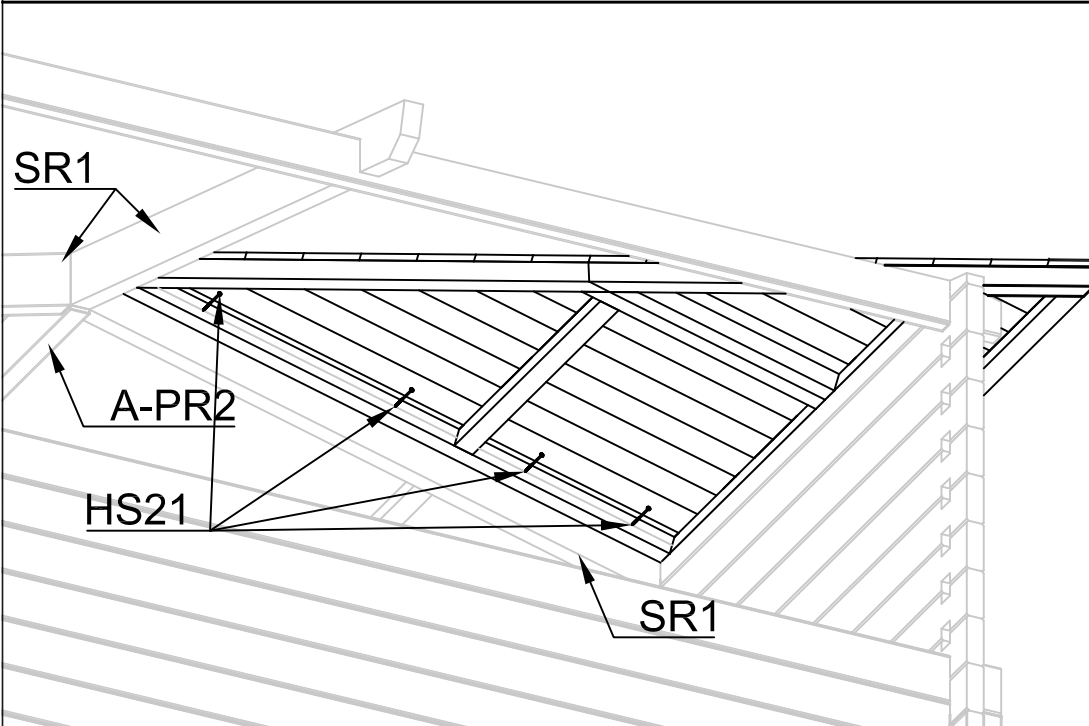

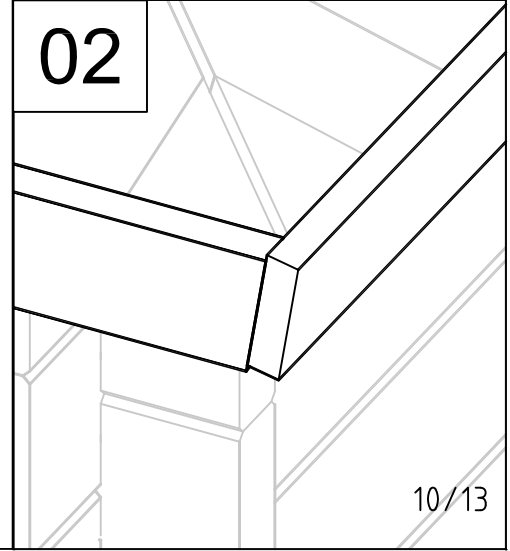
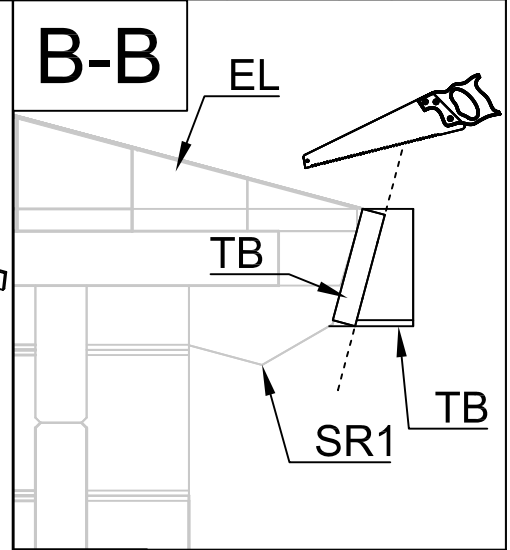
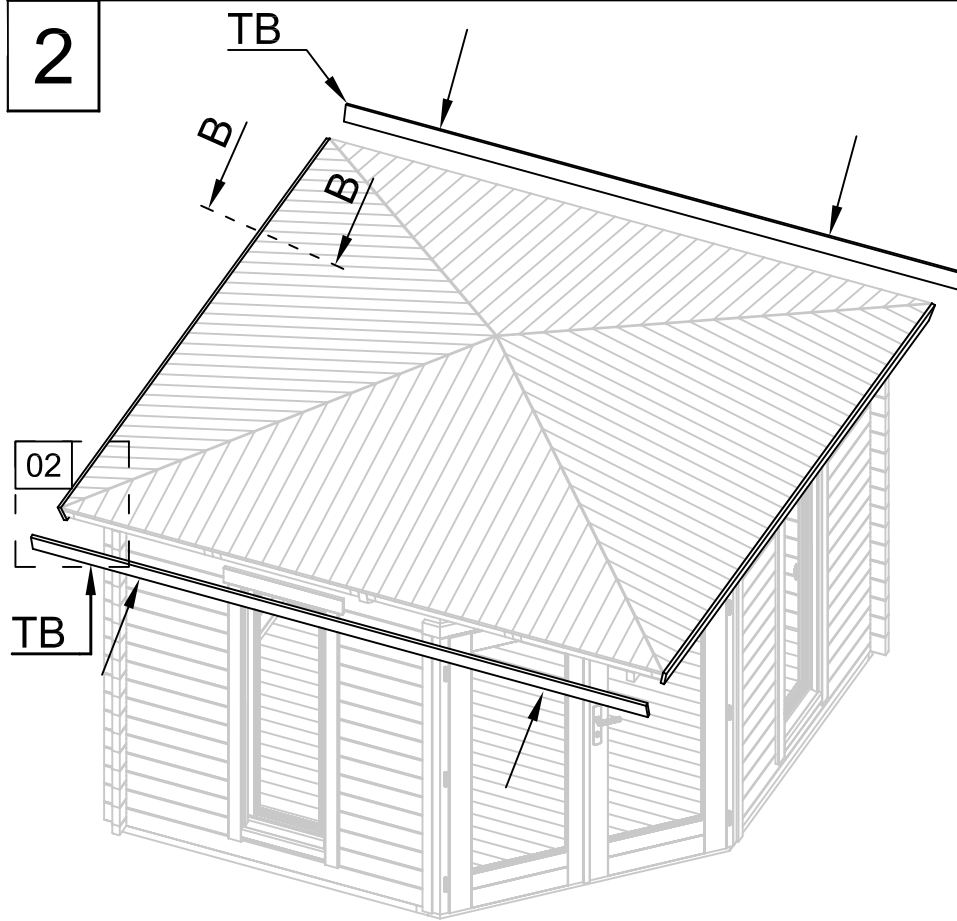
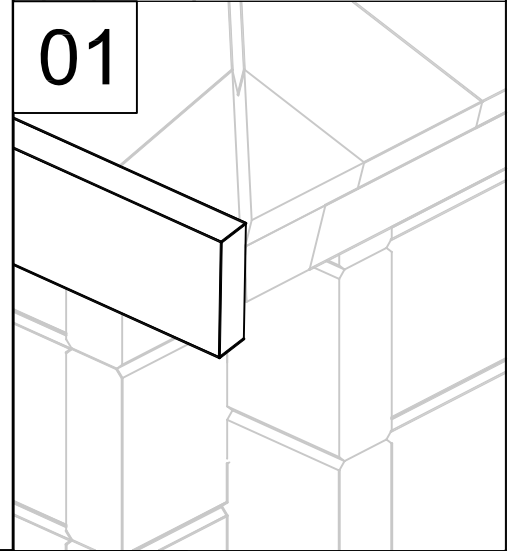
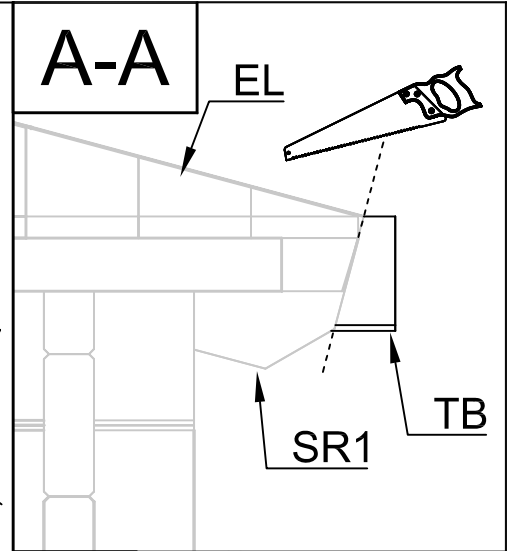
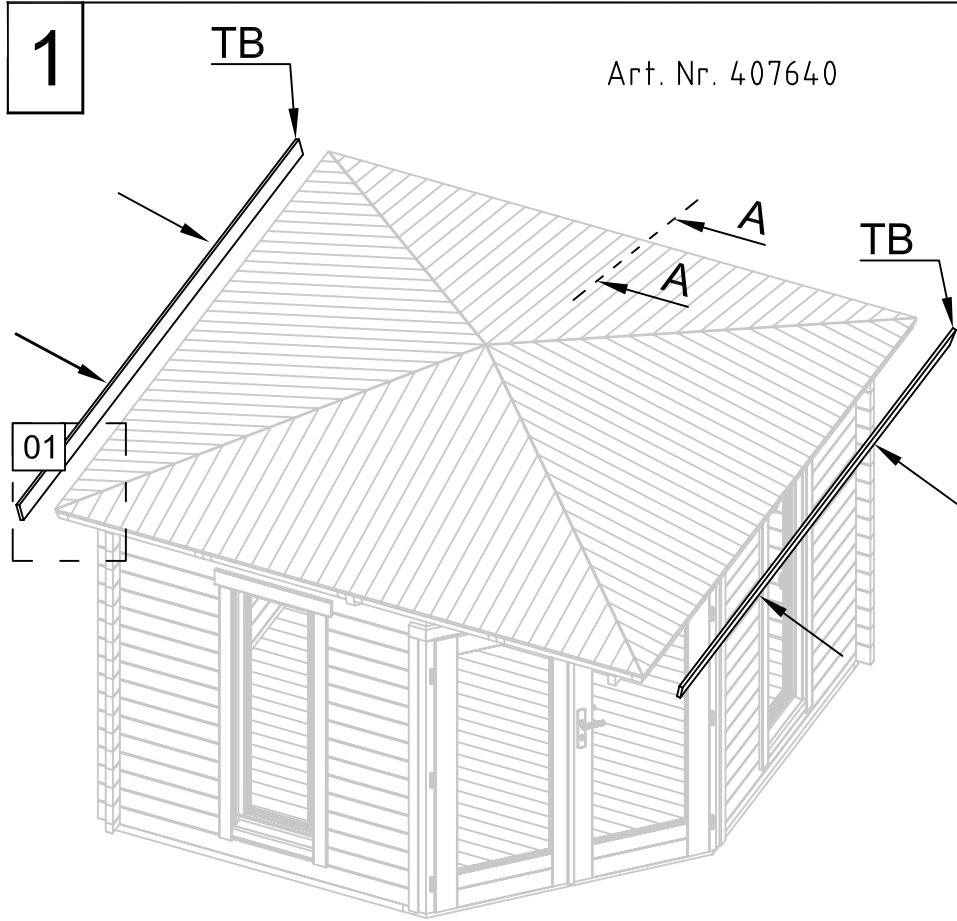

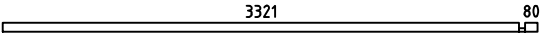
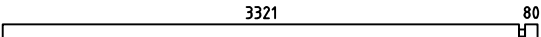

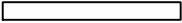
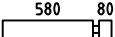
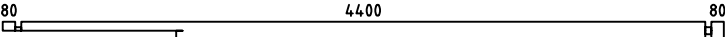
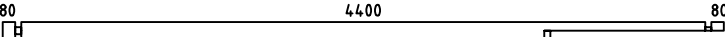
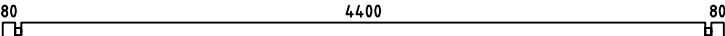
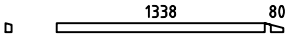
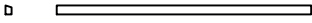
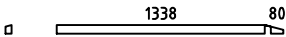
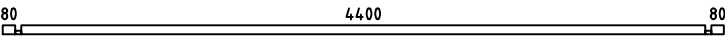
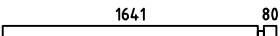
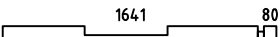
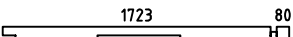
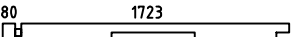
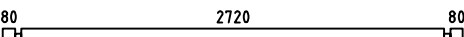
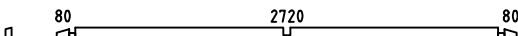

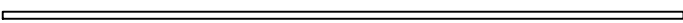
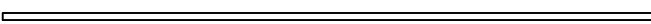
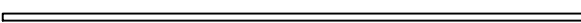
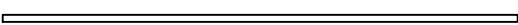

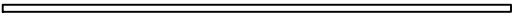

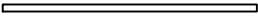
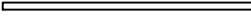
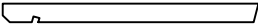





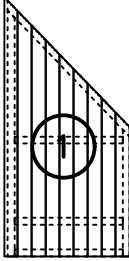
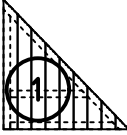
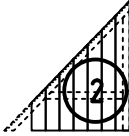
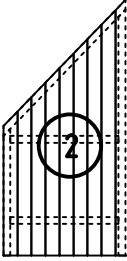
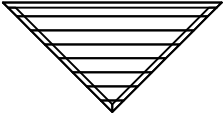

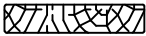





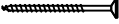
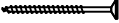
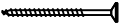







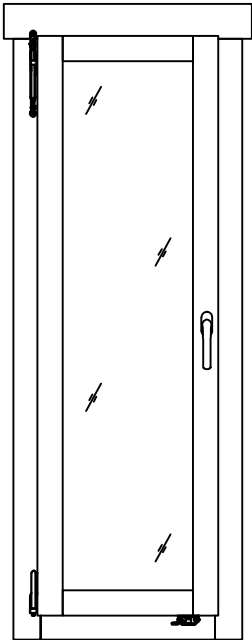
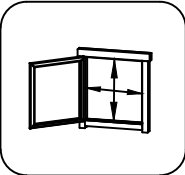



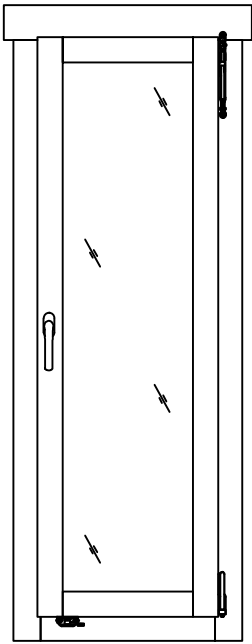
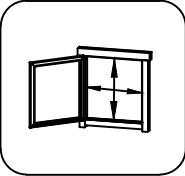

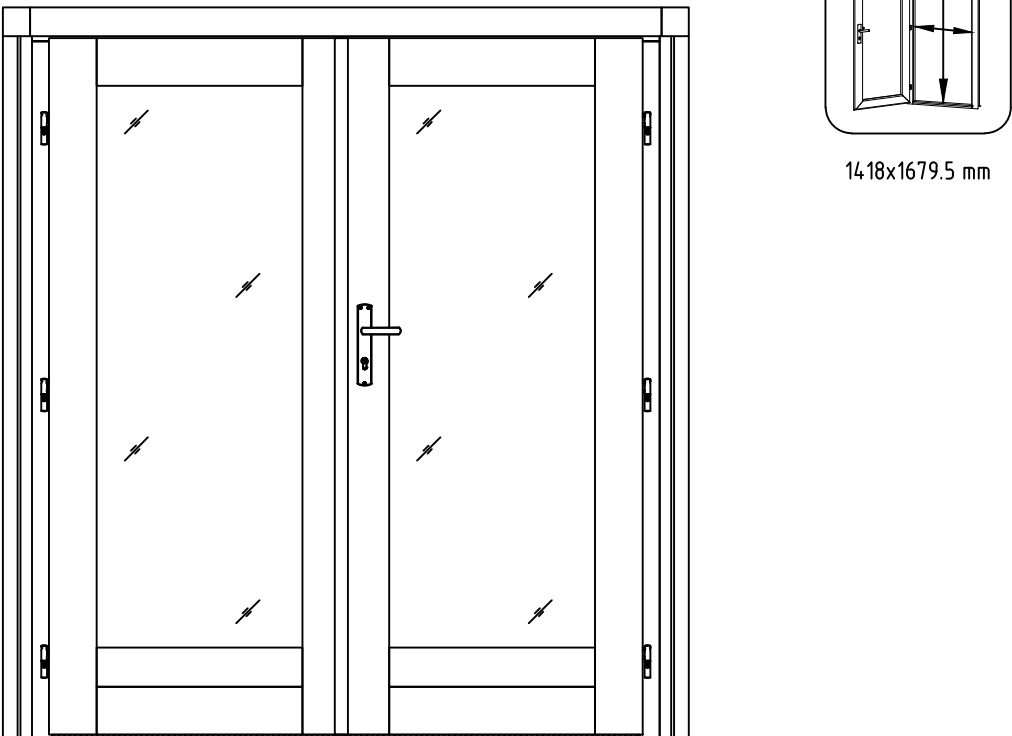

Pos	Piece list - Stückliste - Liste des pièces - Elementi - Stuklijst - Tükitalabel 08.01.2018 Art. Nr. 407640 11/13	Q	P (mm)	L (mm)
001		1	40x57	3441
002		1	40x114	3441
003		27	40x114	526
004		14	40x114	1145
005		27	40x114	700
006		1	40x114	4640
006a		1	40x114	4640
007		18	40x114	4640
008		2	40x57	1458
009		2	40x57	1636
010		2	40x57	1458
011		1	40x57	4640
012		1	40x114	1761
013		1	40x114	1761
014		1	40x114	1843
014a		1	40x114	1843
015		18	40x114	2960
016		2	40x114	2960
017		1	40x114	1489
IAR5	Foundation - Fundament - Fondation - Fondamenta - Fundering - Immutatud alusraam 	5	45x45	4380
IAR6	Foundation - Fundament - Fondation - Fondamenta - Fundering - Immutatud alusraam 	1	45x45	4184
IAR7	Foundation - Fundament - Fondation - Fondamenta - Fundering - Immutatud alusraam 	1	45x45	3727
IAR8	Foundation - Fundament - Fondation - Fondamenta - Fundering - Immutatud alusraam 	1	45x45	3314

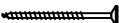
Pos	Piece list - Stückliste - Liste des pièces - Elementi - Stuklijst - Tükitalabel 08.01.2018 Art. Nr. 407640 12/13	Q	P (mm)	L (mm)
IAR9	Foundation - Fundament - Fondation - Fondamenta - Fundering - Immutatud alusraam 	1	45x45	3269
IAR4	Foundation - Fundament - Fondation - Fondamenta - Fundering - Immutatud alusraam 	1	45x45	2790
IAR2	Foundation - Fundament - Fondation - Fondamenta - Fundering - Immutatud alusraam 	1	45x45	1698
IAR3	Foundation - Fundament - Fondation - Fondamenta - Fundering - Immutatud alusraam 	1	45x45	1634
IAR1	Foundation - Fundament - Fondation - Fondamenta - Fundering - Immutatud alusraam 	1	45x45	1608
SR1	Rafter - Dachsparren - Chevron - Trave - Dak spar - Sarikas 	6	44x120	1645
RV1	Lath - Pfetten - Lisseau - Piccola asse - Gordingen - Roov 	4	44x44	1636
A-PR2	Roof beam - Dachbalken - Panne de toit - Perlina del tetto - Gordingen / dakbalk - Pärilin 	1	44x120	1724
A-PR1	Roof beam - Dachbalken - Panne de toit - Perlina del tetto - Gordingen / dakbalk - Pärilin 	2	44x120	1636
	Floor boards - Fussbodenbretter - Lame de plancher - Pavimento - Vloerhout - Põrandalaud 	49	90x18	2716
	Roof boards - Dachbretter - Voliges - Perlina per tetto - Dakhout - Katuselaud 	38	90x18	1668
EL	Roof element - Dachelement - Panneau de toit prémonté - Componente del tetto Dakelement - Katusekilp  	4	1612x1688	
EL	Roof element - Dachelement - Panneau de toit prémonté - Componente del tetto Dakelement - Katusekilp  	4	1612x1688	
CS	Ceiling shield - Element - Panneau de toiture - Pannello del soffitto - Plafond bedeking - Laekilp 	1	1409x705	
	Floor fillet - Fussbodenteiste - Corniere de finition du plancher - Finitura per pavimento (battisco pa) - Vloerafwerklijst - Põrandaliist 		18x18	13.59
TB-1	Fascia board - Traufbrett - Bandeau de toit - Finitura lati tetto - Gevellijst - Räästalaud 	4	18x90	2500
TB-2	Fascia board - Traufbrett - Bandeau de toit - Finitura lati tetto - Gevellijst - Räästalaud 	2	18x90	3300
KFS-1	Storm protection - Sturmleiste - Latte anti-tempete - Protezione anti vento - Stormverankering / beveliging - Tormikinnitusliist 	5	22x45	2050
DRV	Roof edge reinforcement - Dachrandverstärkung - Corniere de renfort de bord de toit - Rinforzo x tetto - Dakrand versterking - Räästatugevdus 	2	44x44	1636

Pos	Piece list - Stückliste - Liste des pièces - Elementi - Stuklijst - Tükitalabel 08.01.2018 Art. Nr. 407640 13/13	Q	P (mm)	L (mm)
HS45	Screw for covering moulding - Schrauben für deckungsprofil - Vis de fixation profils horizontaux haut inférieur et extérieur d'encadrement de porte - Vite per cornice di copertura - Schroef voor afdekprofiel - Kruvi piirdelauale 	26	4x40	
HS12	Screw for fascia boards - Schrauben für traufbretter - Vis pour fixation bandeau de toit - Viti x striscia del tetto - Schroef voor gevellijst - Kruvi räästalaualae 	40	4x40	
HS13	Screw for triangular fixing - Montagschraube für dreieckige - Vis d'assemblage pour triangle - Vite per fissaggio triangolare - Schroef voor driehoekig afdekljst - Kruvi kolmnurga monteerimiseks seinale 	10	4x60	
HS13	Screw for roof edge reinforcement - Schrauben für dachrandverstärkung - Vis pour fixation corniere renfort de bord de toit - Viti x rinforzo bordo tetto - Schroef voor dakrand versterking - Kruvi räästatugevdusele 	8	4x60	
HS13	Screw for wall details - Schraube für wand details - Vis pour mur details - Viti per elementi della porta - Schroef voor wand details - Kruvi seinadetailile 	4	4x60	
HS18	Screw for fixing roof elements - Schraube für befestigung dachelementen - Vis de fixation des panneaux de toit - Vite per fissare gli elementi del tetto - Schroef voor bevestiging dakelement - Kruvi kilpide kinnitamiseks seinaga 	48	5x120	
HS18	Screw for beam - Schrauben zur befestigung dachsparren - Vis pour solive (s) - Viti per perline - Schroef voor balk (gording) - Kruvi talale 	26	5x120	
HS16	Screw for 1. wall beam - Schraube für 1. bohlenreihe - Vis de fixations 1ere rangée de madriers avec poutrelles de fondations - Vite fissaggio alle fondamenta - Schroef voor 1 wandbalk - Kruvi poollauale 	7	5x90	
HS16	Screw for foundation - Schrauben zur befestigung fundament - Vis de fixations des poutrelles de fondations - Viti x fondamenta - Schroef voor fundering - Kruvi alusraamile 	16	5x90	
HS16	Screw for roof lath - Schraube für dachlatte - Vis pour latte - Vite per listello del tetto - Schroef voor daklat - Kruvi roovile 	8	5x90	
HS16	Screw for wall details - Schraube für wand details - Vis pour mur details - Viti per elementi della porta - Schroef voor wand details - Kruvi seinadetailidele 	14	5x90	
HS16	Screw for foundation - Schrauben zur befestigung fundament - Vis de fixations des poutrelles de fondations - Viti x fondamenta - Schroef voor fundering - Kruvi alusraamile 	5	5x90	
HS21	Screw for fixing roof elements - Schraube für befestigung - dachelementen - Vis de fixation des panneaux de toit - Vite per fissare gli elementi del tetto - Schroef voor bevestiging dakelement - Kruvi kilpide montaažiks 	120	6x80	
NF2	Zn nail for floor fillet - Zn nägel für fussbodenleiste - Pointe pour corniere de finition du plancher - Chiodi x fissaggio pavimento - Spijker(nagel) voor vloer afdekljst - Nael põrandaliistule 	27	1.4x40	
SH40	Hammer block - Schlagholz - Calle de frappe - Blocco di legno da usare come cuscinetto quando si usa il martello - Slagklos - Löögiklots 	1		
SFS	Nut for storm protection - Schraubenmutter für sturmleiste - Ecrou pour latte anti-tempete - Dado x asta protezione vento - Moer voor stromverankering - Mutter tormikinnitusliistule 	10	D6	
NF4	Zn nail for roof - Zn nägel für dachbretter - Pointe pour fixation voliges de toit - Chiodi x perline tetto - Spijker(nagel) voor dakhout - Nael katuselauale 	164	2x50	
NF4	Zn nail for floor - Zn nägel für fussbodenbretter - Clous pour plancher - Chiodi x perline pavimento - Spijker(nagel) voor vloer - Nael põrandalauale 	346	2x50	
BFS	Bolt for storm protection - Bolzen für sturmleiste - Boulon pour latte anti-tempete - Bullone x asta protezione vento - Bout voor stormankerlat - Puidupolt tormikinnitusliistule 	10	6x70	
DFS	Washer for storm protection - Dichtscheibe für sturmleiste - Rondelle pour latte anti-tempete - Rondella x asta protezione vento - Afdichtring voor storm strip - Seib tormikinnitusliistule 	10	D6	
	Window - Fenster - Fenetre - Finestra - Raam - Aken 525X1560 AK.1.100.TPSP.j DGP+	1		
	Window - Fenster - Fenetre - Finestra - Raam - Aken 525x1560 AK.1.100.TPSV.j DGP+	2		
	Door - Tür - Porte - Porte - Deur - Uks 1494x1736 TUK.1.100.TPVP.MM5c DGP+	1		

Pos	31.10.2017 Piece list - Stückliste - Liste des pièces - Elementi - Stuklijst - Tükítabel 525x1560 AK.1.100.TPSV.j DGP+	1/1	Q	P (mm)	L (mm)
	<p data-bbox="256 141 1289 174">Glass size - Glasgröße - Taille de la vitre - Misura del vetro - Glas afmeting - Klaasi mõõt: 355x1382 mm</p>   <p data-bbox="1362 338 1497 365">425x1472 mm</p>				
FS2	<p data-bbox="261 2130 1023 2186">Window handle fittings - Fenstergriff - Poignée de fenetre - Maniglia c/ferramenta - Raamhendel -/grendel -/klink - Aknalink</p>		1		

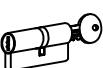
Pos	31.10.2017 Piece list - Stückliste - Liste des pièces - Elementi - Stuklijst - Tükitalabel 525x1560 AK.1.100.TPSP.j DGP+	1/1	Q	P (mm)	L (mm)
	<p data-bbox="256 152 1289 185">Glass size - Glasgröße - Taille de la vitre - Misura del vetro - Glas afmeting - Klaasi mõõt: 355x1382 mm</p>   <p data-bbox="1362 344 1497 378">425x1472 mm</p>				
FS2	<p data-bbox="261 2130 1023 2186">Window handle fittings - Fenstergriff - Poignee de fenetre - Maniglia c/ferramenta - Raamhendel -/grendel -/klink - Aknalink</p>		1		

Pos	31.10.2017	Piece list - Stückliste - Liste des pièces - Elementi - Stuklijst - Tükítabel 14.94x1736 TUK.1.100.TPVP.MM5c DGP+	1/1	Q	P (mm)	L (mm)
		Glass size - Glasgröße - Taille de la vitre - Misura del vetro - Glas afmeting - Klaasi mõõt: 561x1593 mm				
HS4	Screw for door fillet - Schraube zur Befestigung Türleiste - Vis pour fixation baguette d'arrêt de porte - Viti per massellino della porta - Schroef voor deurlijst - Kruvi ukse kokkuvaltšiliistule		5	3x30		
HS16	Screw for door jamb - Schraube für Türrahmen - Vis de fixation partie haute avec montants du cadre de porte - Viti x fissaggio montanti porte - Schroef voor deurkozijn - Kruvi ukse lengile		4	5x90		
HS25	Screw for doorstep - Schrauben für Swelle - Vis pour fixation barre de seuil - Vite per soglia della porta - Schroef voor deurdorpel - Kruvi lävepakule		3	4.5x65		
HS9	Screw for fixing door to the wall - Schraube zur Befestigung Tür - zarge mit Wand - Vis de fixation partie basse dormants de porte au 1er rang de madrier - Viti per fissare la porta alla parete - Schroef voor bevestiging deur naar wand - Kruvi ukse lengi kinnitamiseks seinale		2			
MH	Male bolt hinge for door - Türband - Partie male de paumelle de porte - Cerniera anube x porta - Scharnier bout - Reguleeritav polthing isane		6	14x80		
HC	Covers for door hinges - Schutzkappe für Türband - Couverture de paumelle de porte - Copertura delle cerniere della porta - Afdek kap voor deurscharnier - Reguleeritava polthinge kate		12			
TL4	Door handle fittings - Türgriff - Poignée de porte - Maniglie - Deurhendel klink - Ukse käepide		1			
TL5	Set of door lock covers - Schlossblenden - Set de garnitures de porte - Copertura serrature - Slot sluitplaat set - Ukse lukuplaat		1			
	Cylinder lock - Zylinderschloss - Barillet de porte - Serratura - Cylinder slot - Ukse lukusüdamik		1	30x35		
	Striker for barrel bolt - Hülse für Grendelriegel - Gache au sol du targette - Boccola per fermo della porta - Huls voor vergrendelingsschuif - Vasturaud ukse servariivile		2			



Allgemeine Montageanleitung - General assembly instructions - Instructions générales de montage

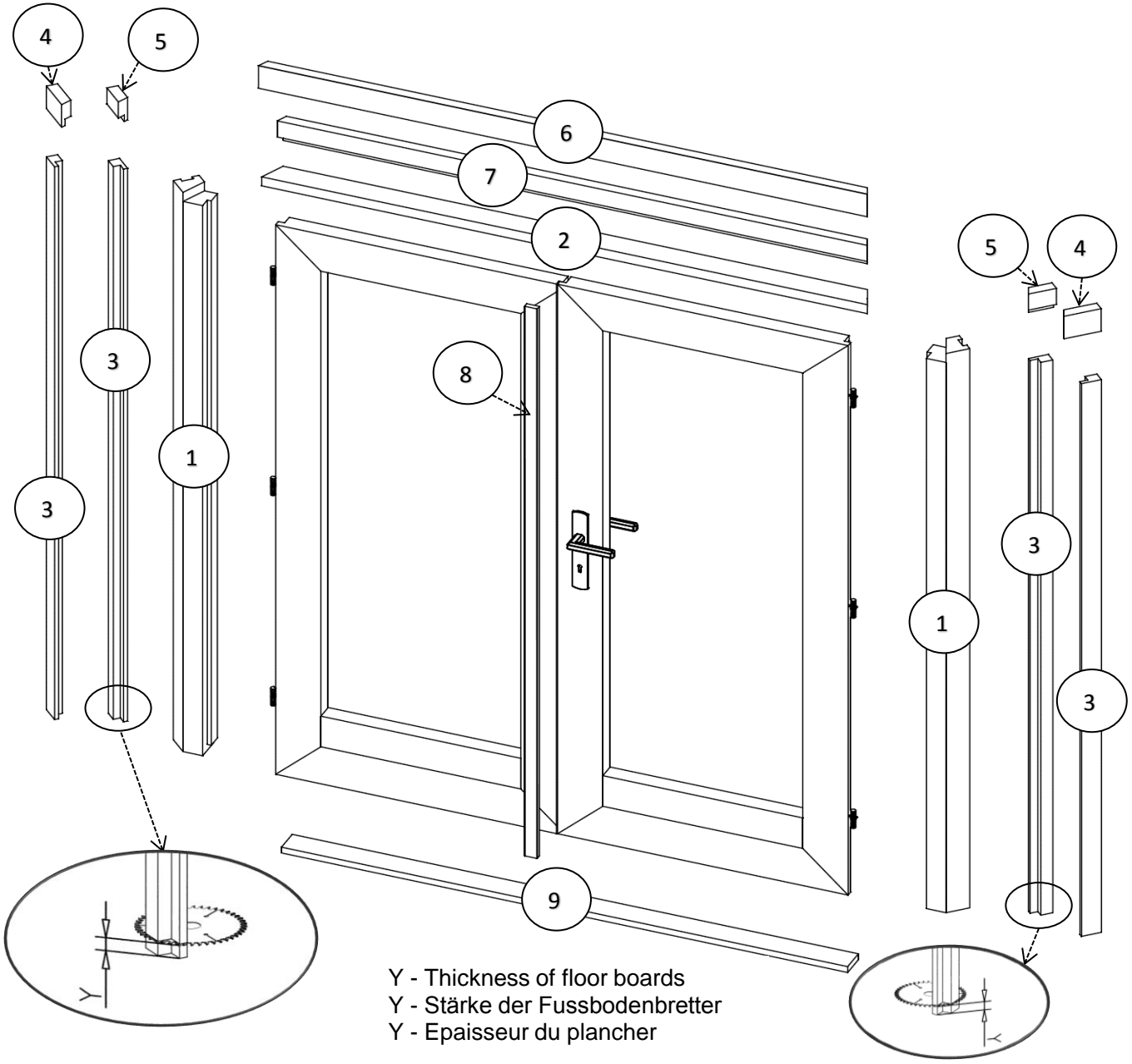

Pos	Piece list - Stückliste - Liste des pièces	Q.	P (mm)	L (mm)
1		2	77x60	1736
2		1	77x38	1538
3		4	28x50	1721
4		2	28x70	94
5		2	28x70	66
6		1	28x70	1546
7		1	28x70	1489
8		1	13x32	1706
9		1	18x77	1438

