

Borkum 3
Art. Nr. 401600
1/8



18.01.2017

Art. Nr. 401600

GROUNDPLAN - GRUNDPLAN - PLAN DE MASSE

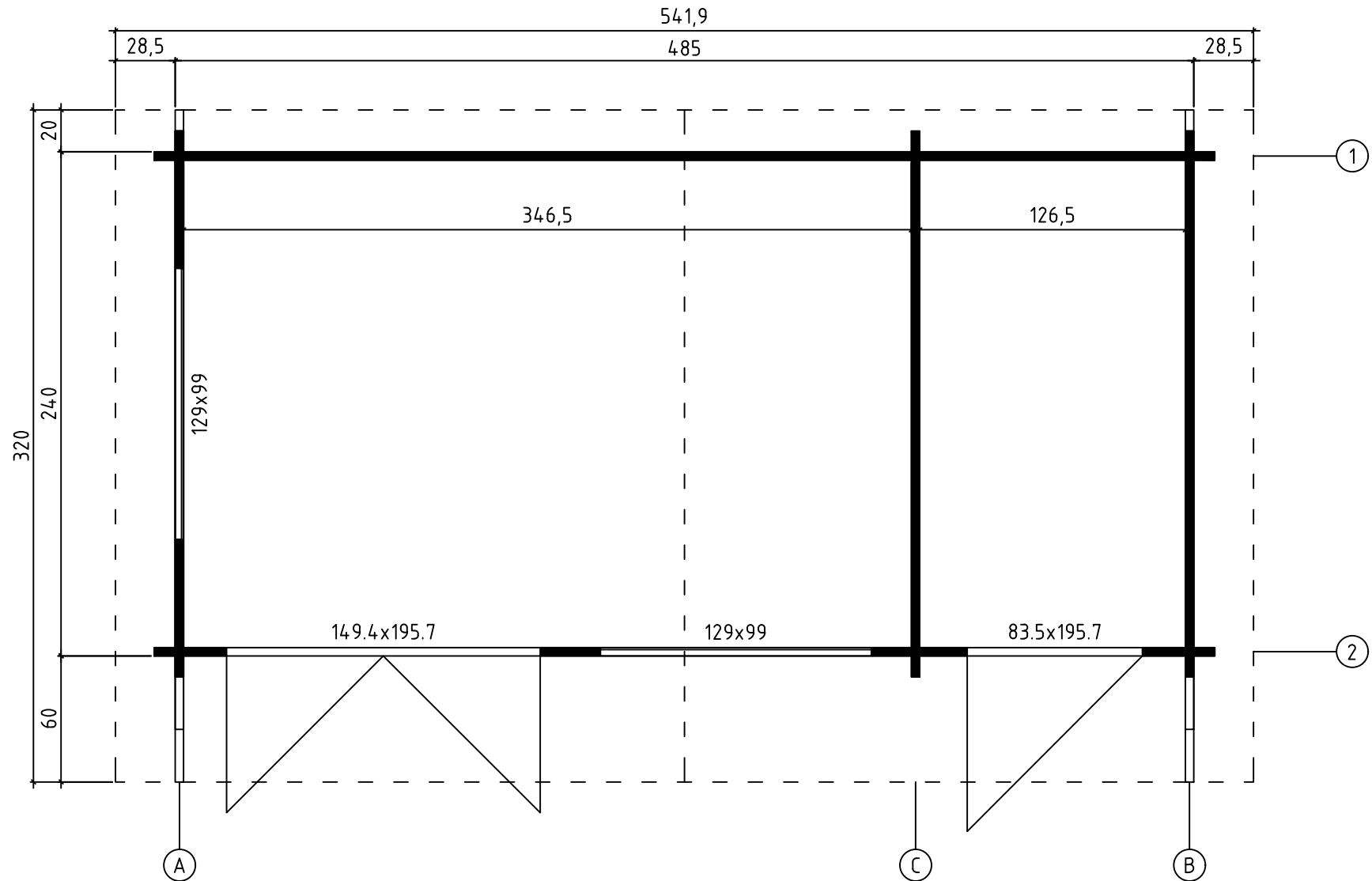

FOUNDATION - FUNDAMENT - FONDATION

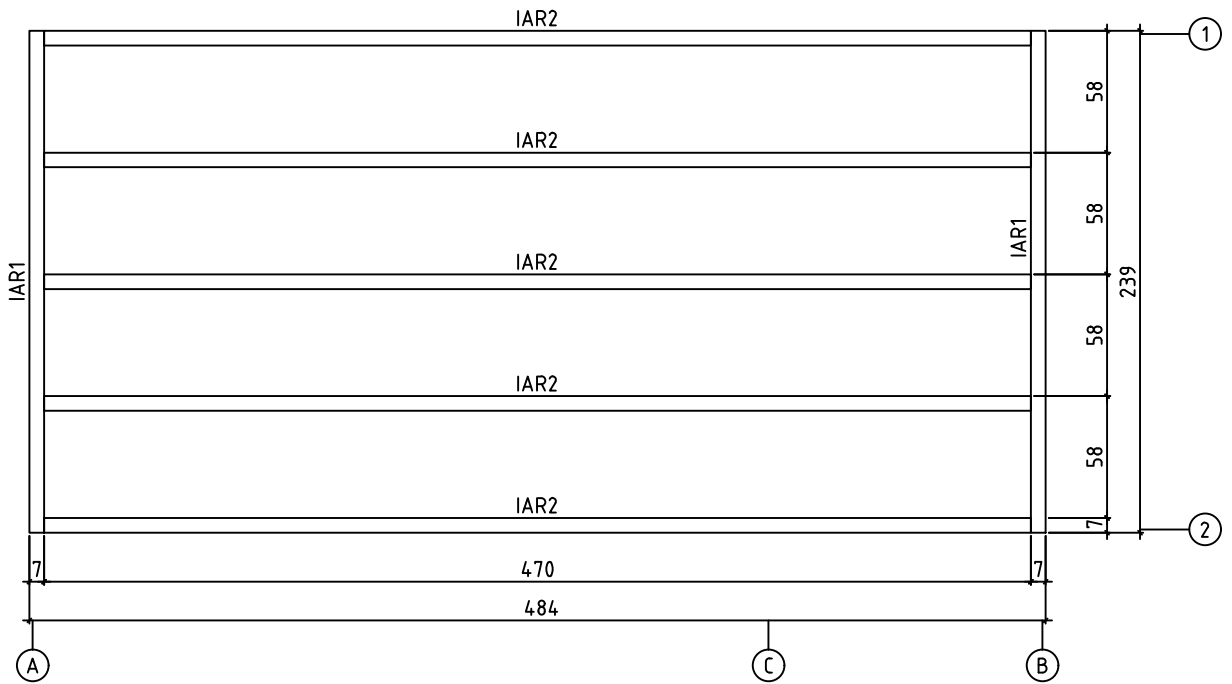

FLOOR BOARDS - FUSSBODENBRETTER - PLAN POSE PLANCHER

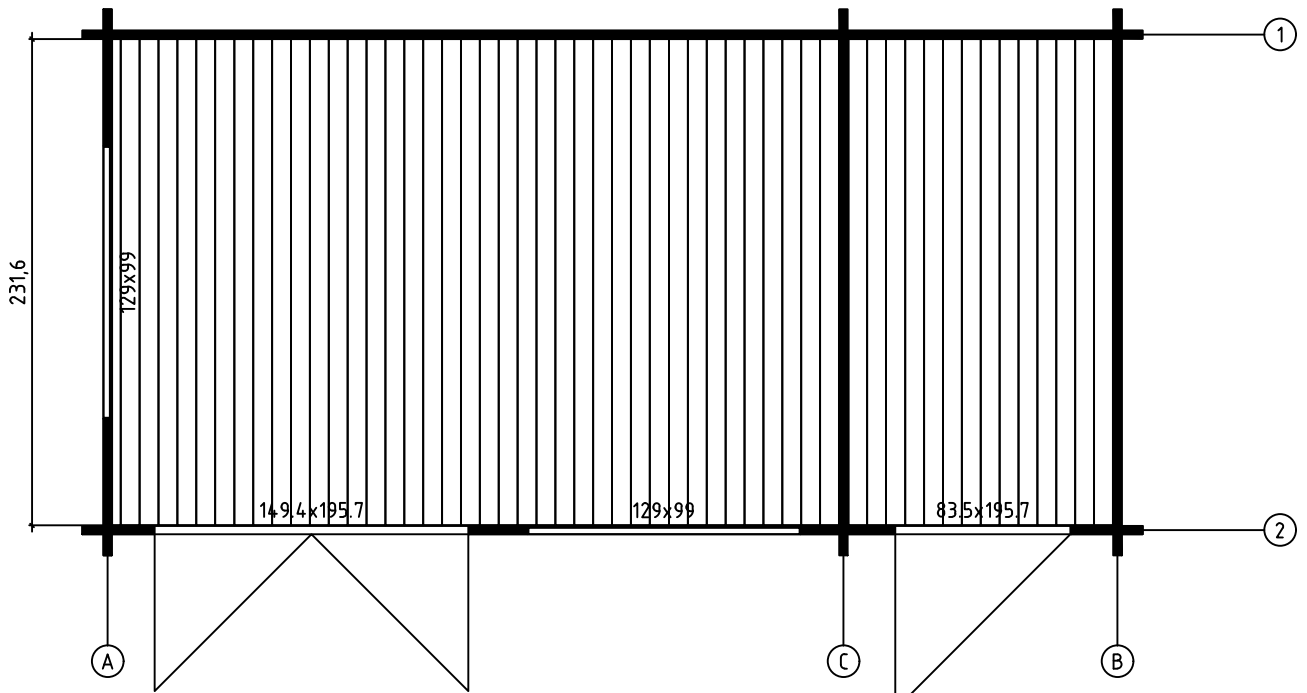

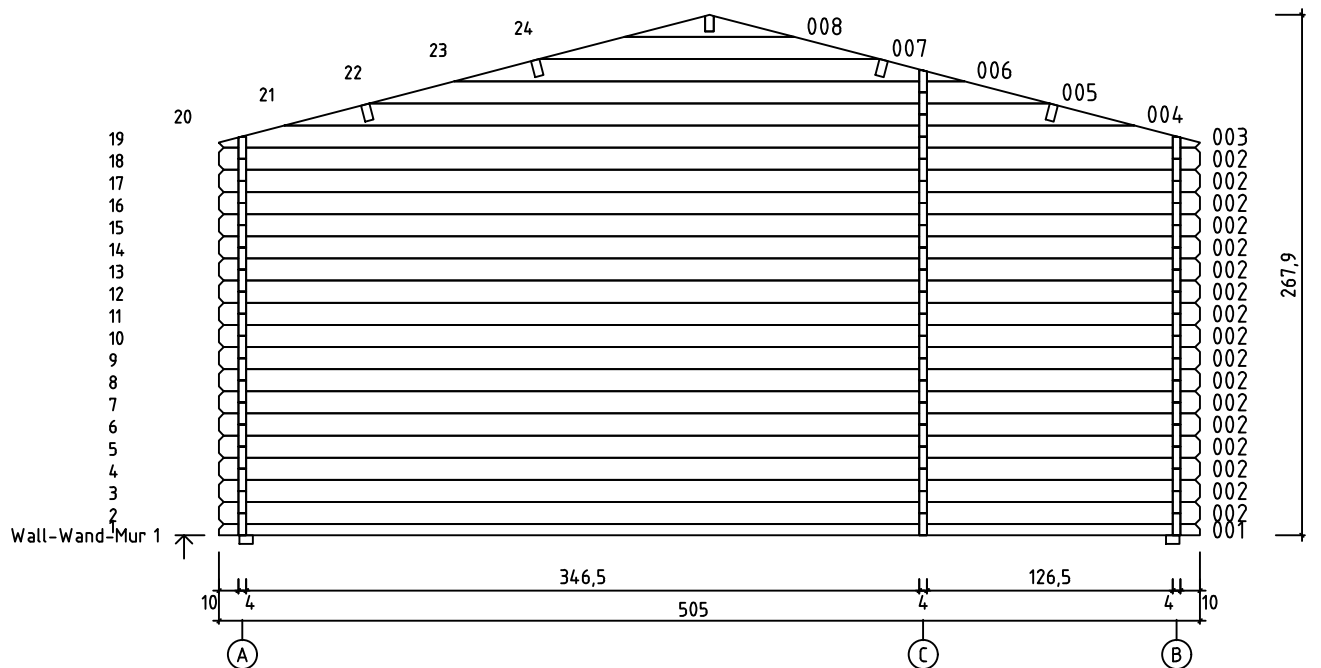
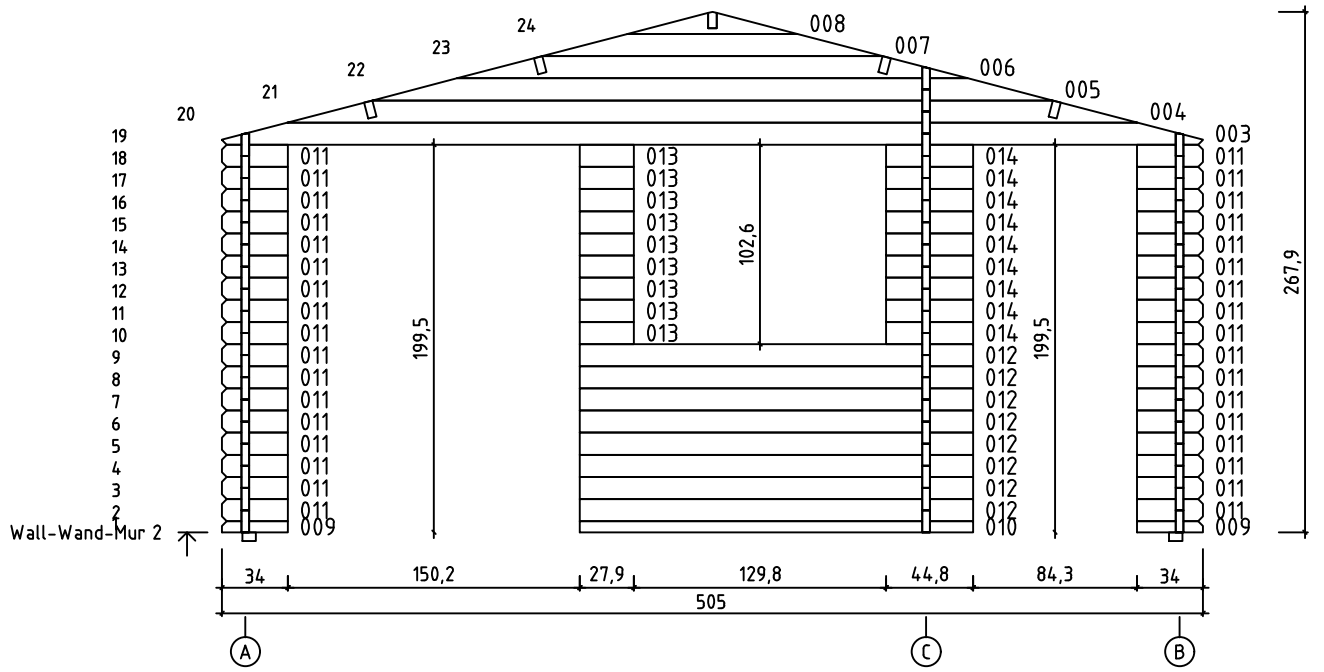



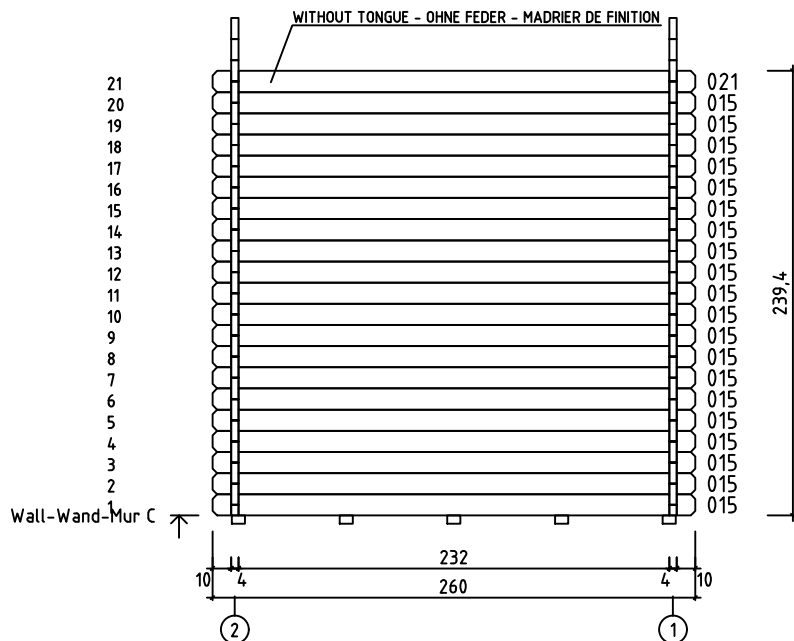
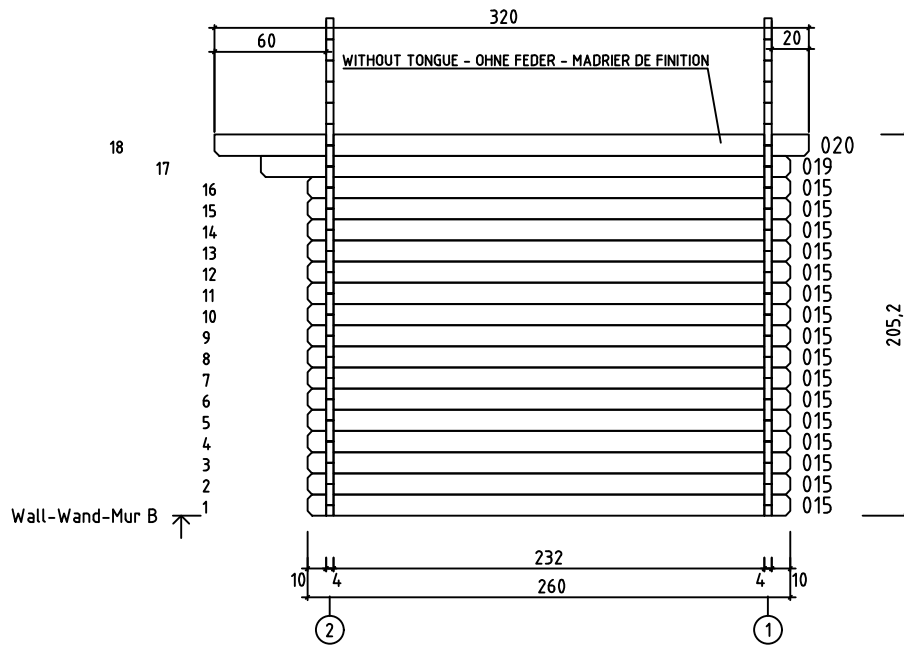
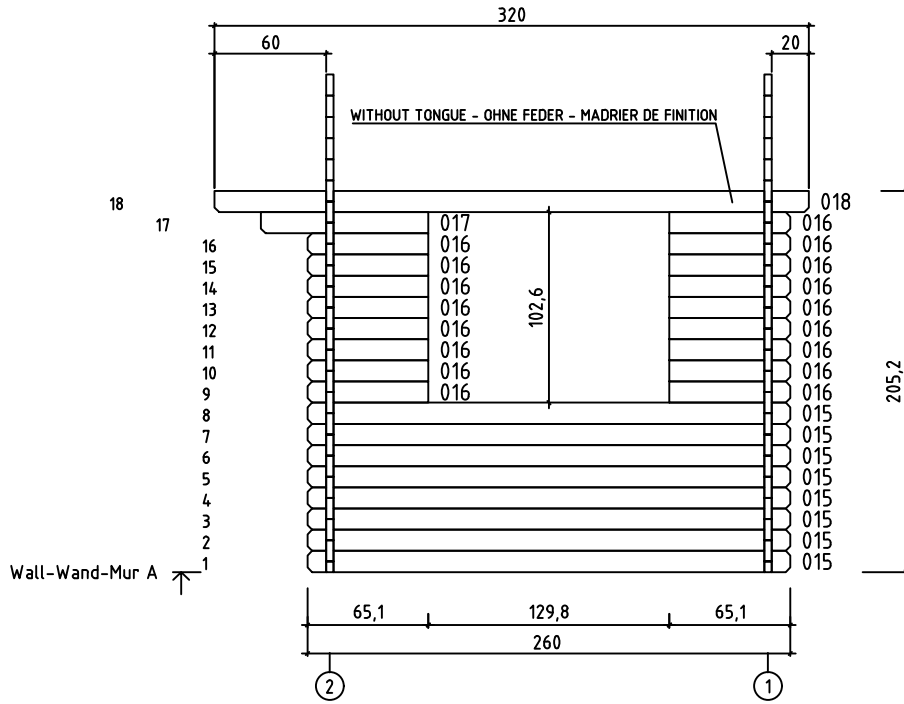



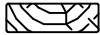

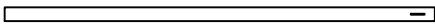
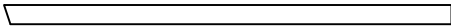

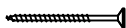

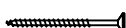
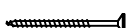







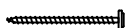
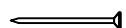
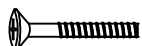

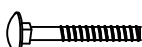
Art. Nr. 401600

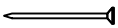
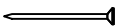

Pos	18.01.2017	Piece list - Stückliste - Liste des pièces Art. Nr. 401600	6/8	Q.	P (mm)	L (mm)
001				1	40x57	5050
002				17	40x114	5050
009				2	40x57	340
010				1	40x57	2025
011				34	40x114	340
012				8	40x114	2025
013				9	40x114	279
014				9	40x114	448
015				44	40x114	2600
016				17	40x114	651
017				1	40x114	901
018				1	40x120	3200
019				1	40x114	2850
020				1	40x120	3200
021				1	40x114	2600
W1-1				1		
W2-1				1		
IAR2		FOUNDATION - FUNDAMENT - FONDATION 		5	70x45	4700
IAR1		FOUNDATION - FUNDAMENT - FONDATION 		2	70x45	2390
PPR1		ROOF BEAM - DACHBALKEN - PANNE DE TOIT 		1	44x140	3200
PR21		ROOF BEAM - DACHBALKEN - PANNE DE TOIT 		4	44x140	3200
		FLOOR BOARDS - FUSSBODENBRETTER - LAME DE PLANCHER 		54	90x18	2316
		ROOF BOARDS - DACHBRETTER - VOLIGES 		72	90x18	2800

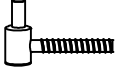
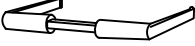
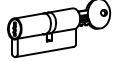
Pos	18.01.2017	Piece list - Stückliste - Liste des pièces Art. Nr. 401600	7/8	Q.	P (mm)	L (mm)
		FLOOR FILLET-FUSSBODENLEISTE - CORNIERE DE FINITION DU PLANCHER			18x18	18.71
		ROOFING FELT FILLET - DACHPAPPENLEISTE - BAGUETTE DE FIXATION DU FEUTRE BITUMEUX		4	18x58	2850
		EAVES BOARD - TRAUFBRETT - BANDEAU DE TOIT		2	18x90	3200
		ROOF EDGE REINFORCEMENT - DACHRANDVERSTÄRKUNG - CORNIERE DE RENFORT DE BORD DE TOIT		2	28x34	3200
		STORM PROTECTION - STURMLEISTE LATTE ANTI-TEMPETE		4	22x45	2050
		GABLE MOULDING - GIEBELLEISTE PLANCHE DE RIVE		4	18x120	2850
		WINDOW HANDLE FITTINGS-FENSTERGRIFF - POIGNÉE D'OUVERTURE DE FENETRE		2		
		SCREW FOR GABLE SEGMENT - SCHRAUBEN FÜR DECKBLATT - VIS POUR FIXATION LOSANGE DE FINITION		4	3.5x35	
		SCREW FOR GABLE MOULDING - SCHRAUBEN FÜR GIEBELLEISTE - VIS DE FIXATION POUR PLANCHE DE RIVE		32	3.5x50	
		SCREW FOR DOOR FILLET - SCHRAUBE ZUR BEFESTIGUNG TÜRLEISTE - VIS D'ASSEMBLAGE DU CADRE DE PORTE		5	3x30	
		SCREW FOR EAVES BOARDS - SCHRAUBEN FÜR TRAUFBRETT - VIS DE FIXATION POUR BANDEAU DE TOIT		14	4x40	
		SCREW FOR ROOF EDGE REINFORCEMENT - SCHRAUBEN FÜR DACHRANDVERSTÄRKUNG - VIS POUR RENFORT DE BORD DE TOIT		14	4x40	
		SCREW FOR FUNDAMENT - SCHRAUBEN ZUR BEFESTIGUNG FUNDAMENT - VIS POUR FONDATION		10	5x120	
		SCREW FOR ROOF BEAMS - SCHRAUBEN FÜR DACHBALKEN - VIS POUR PANNE DE TOIT		16	5x120	
		SCREW FOR GABLE - SCHRAUBEN FÜR GIEBEL - VIS POUR FIXATION DES PIGNONS		24	5x120	
		SCREW FOR 1. WALL BEAM - SCHRAUBE FÜR 1. BOHLENREIHE - VIS DE FIXATION DES FONDATIONS		10	5x90	
		SCREW FOR DOOR JAMB - SCHRAUBE FÜR TÜRRAHMEN - VIS DE FIXATION POUR MONTANT DE PORTE		4	5x90	
		ZN NAIL FOR FLOOR FILLET - ZN NÄGEL FÜR FUSSBODENLEISTE - POINTE POUR CORNIERE DE FINITION DU PLANCHER		37	1.4x40	
		HAMMER BLOCK - SCHLAGHOLZ - CALLE DE FRAPPE		1		
		SCREW FOR DOORSTEP - SCHRAUBEN FÜR TÜRSWELLE - VIS DE FIXATION DU SEUIL DE PORTE		5	4.5x65	
		ZN NAIL FOR ROOFING FELT FILLET - ZN NÄGEL FÜR DACHPAPPENLEISTE - POINTE POUR BAGUETTE FIXATION FEUTRE BITUMEUX		28	2x40	
		BOLT FOR WINDOW HANDLE FITTINGS - BOLZEN FÜR FENSTERGRIFF BESCHLAG - BOULON POUR POIGNÉE D'OUVERTURE DE FENETRE		4		
		GABLE SEGMENT-DECKBLATT - LOSANGE DE FINITION		2		
		NUT FOR STORM PROTECTION - SCHRAUBENMUTTER FÜR STURMLEISTE - ÉCROU POUR LAME ANTI-TEMPETE		8	D6	
		BOLT FOR STORM PROTECTION - BOLZEN FÜR STURMLEISTE - VIS POUR LAME ANTI-TEMPETE		8	6x70	

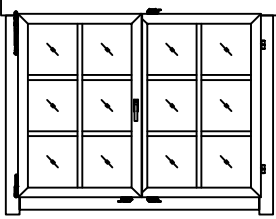
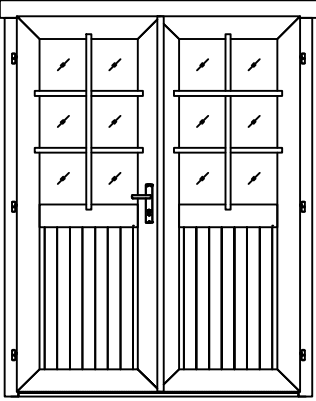
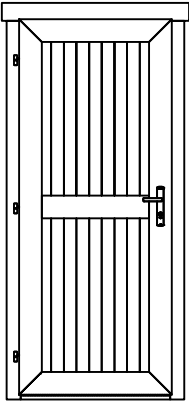
Pos	18.01.2017	Piece list - Stückliste - Liste des pièces Art. Nr. 401600	8/8	Q.	P (mm)	L (mm)
		WASHER FOR STORM PROTECTION - DICHTSCHEIBE FÜR STURMLEISTE - RONDELLE POUR LAME ANTI-TEMPETE		8	D6	
		ZN NAIL FOR ROOF - ZN NÄGEL FÜR DACHBRETTER - POINTE POUR TOIT		308	2x50	
		ZN NAIL FOR FLOOR - ZN NÄGEL FÜR FUSSBODENBRETTER - CLOUS POUR PLANCHER		280	2x50	
		SET OF DOOR LOCK COVERS - SCHLOSSBLENDEN - SET DE GARNITURES DE SERRURE DE PORTE		2		
		MALE BOLT HINGE FOR DOOR - TÜRRIEGEL - PARTIE MALE DE CHARNIERE DE PORTE		6		
		DOOR HANDLE FITTINGS-TÜRGRIF - SET DE GARNITURES DE SERRURE DE PORTE		2		
		CYLINDER LOCK - ZYLINDERSCHLOSS - CYLINDRE DE SERRURE		2	30x35	
		STRIKER FOR BARREL BOLT - HÜLSE FÜR GRENDLRIEGEL - GACHE AU SOL DU TARGETTE		2		
		WINDOW-FENSTER-FENETRE 1290x990 	TAK.1.106.SSV.b SGC	2		
		DOOR-TÜR-PORTE 1494x1957 	TUK.2.056.SVV.MMb SGC	1		
		DOOR-TÜR-PORTE 835x1957 	UL.2.100.IVV.MM TC	1		