

Cyprus 2B
Art. Nr. 280400

1/8

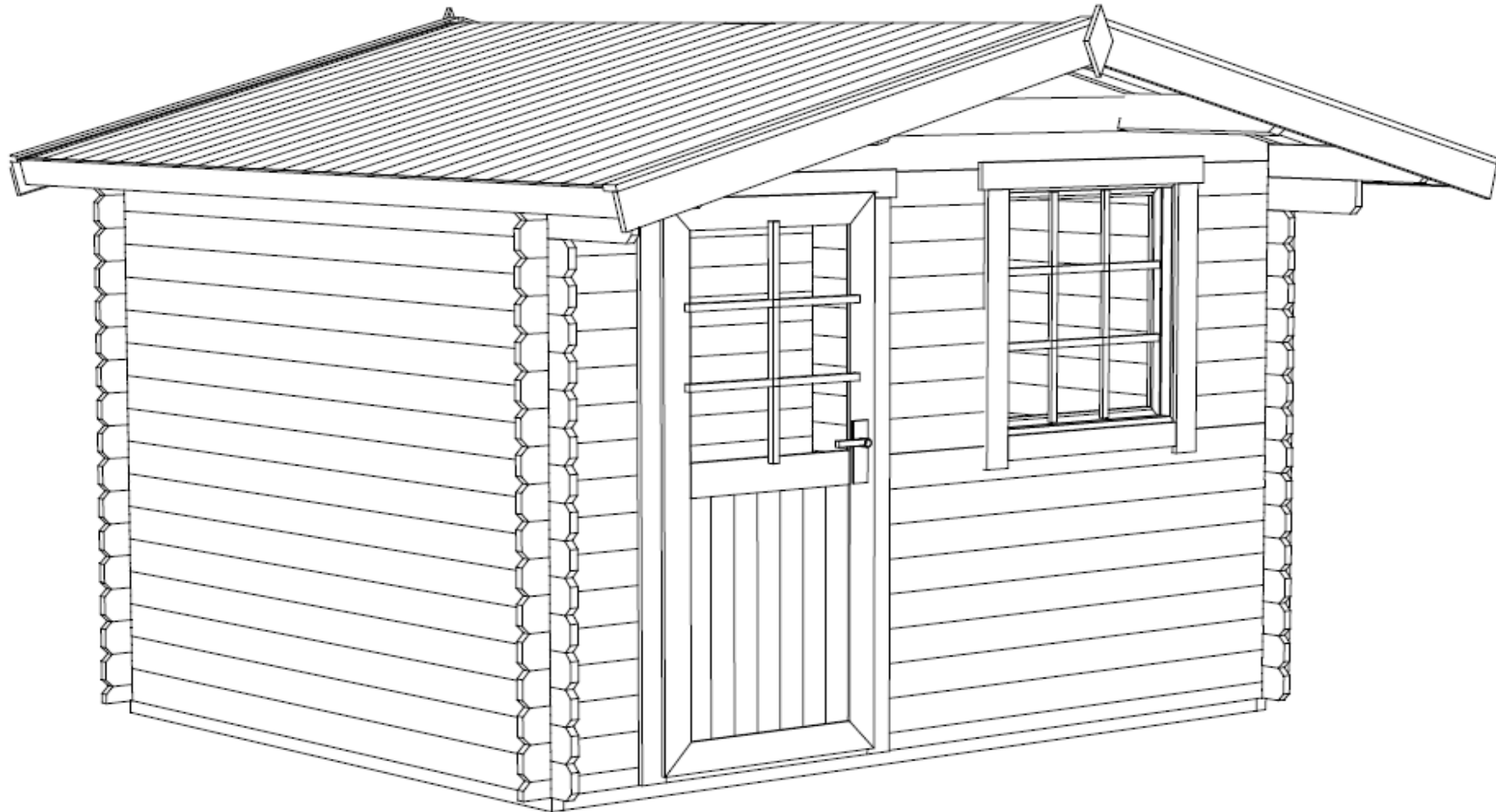

14.10.2014

Art.Nr. 280400

GROUNDPLAN - GRUNDPLAN - PLAN DE MASSE

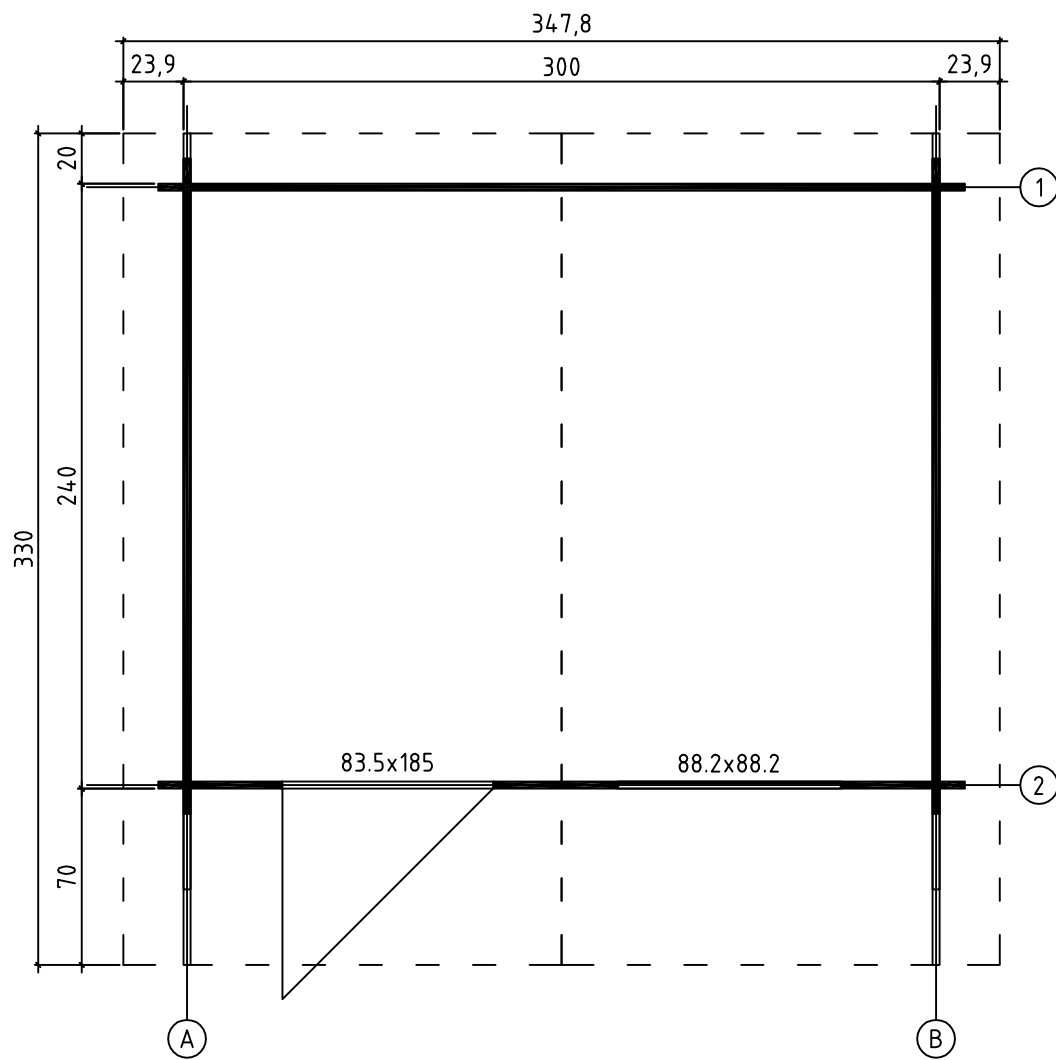

Art.Nr. 280400

FOUNDATION - FUNDAMENT - FONDATION

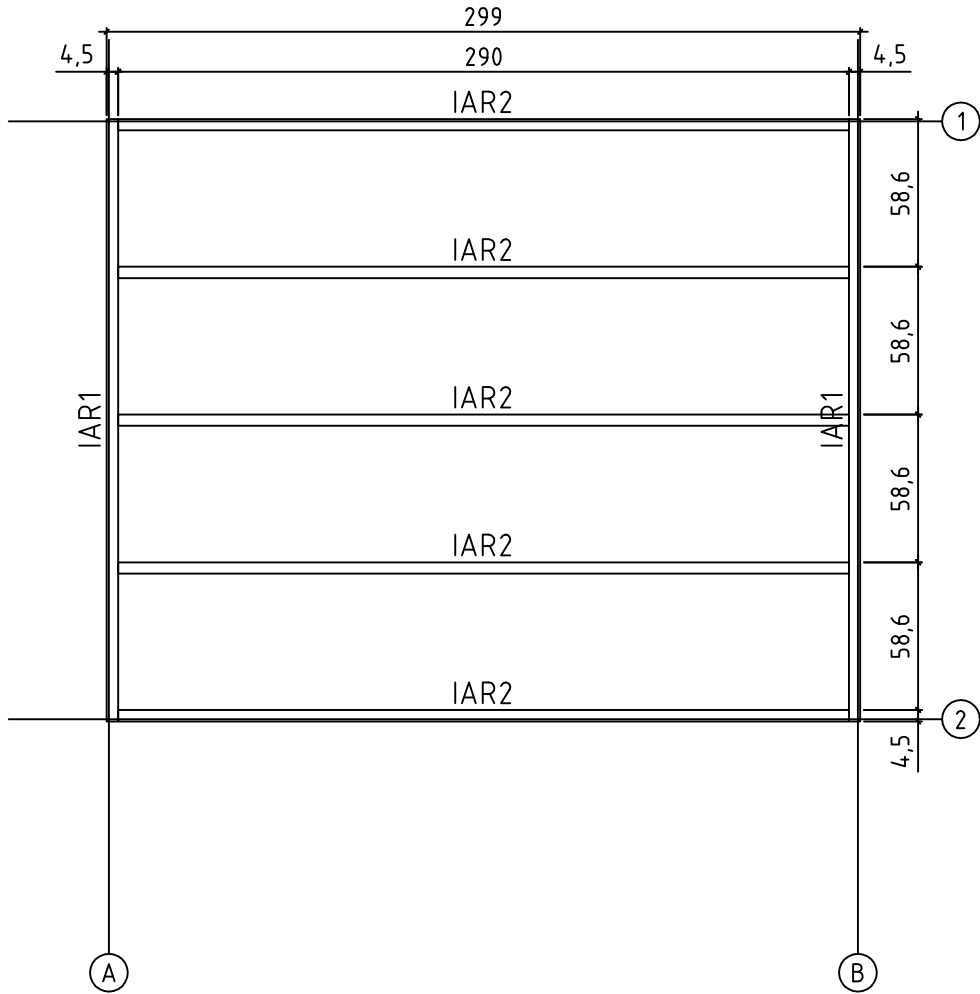

FLOOR BOARDS - FUSSBODENBRETTER -
- PLAN POSE PLANCHER

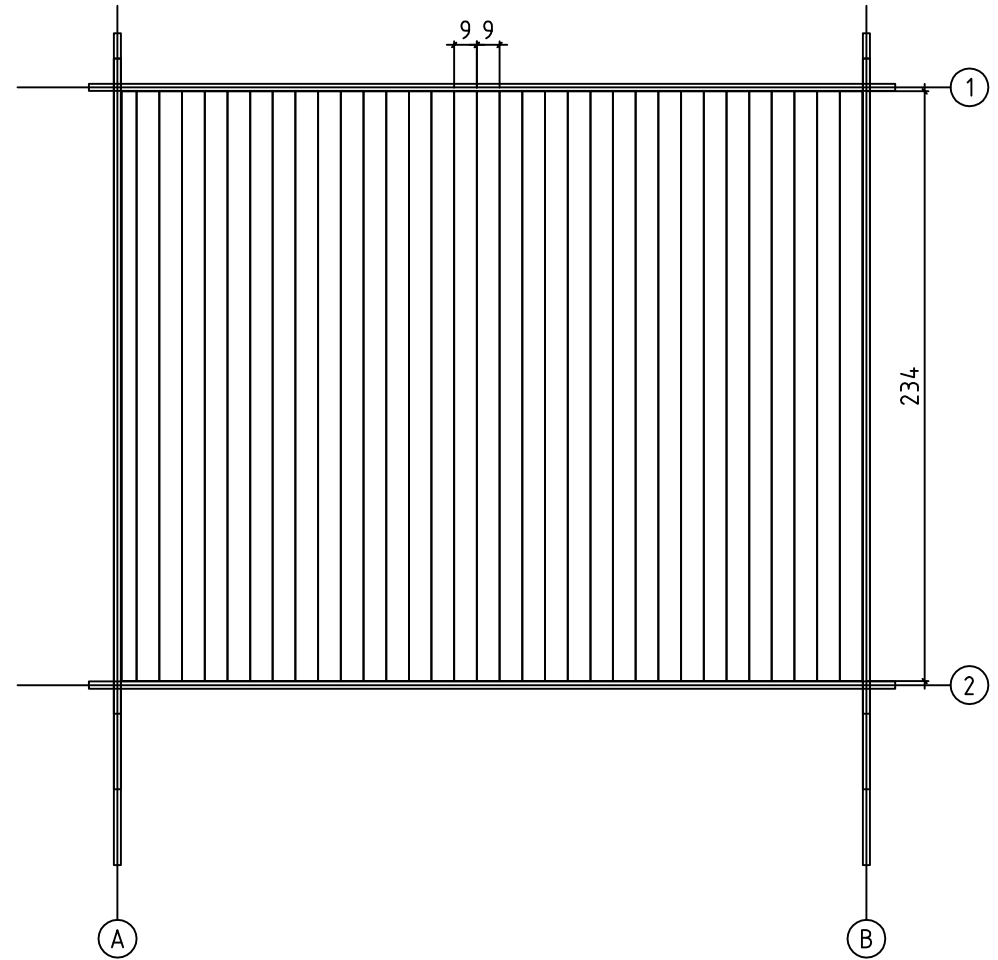

14.10.2014





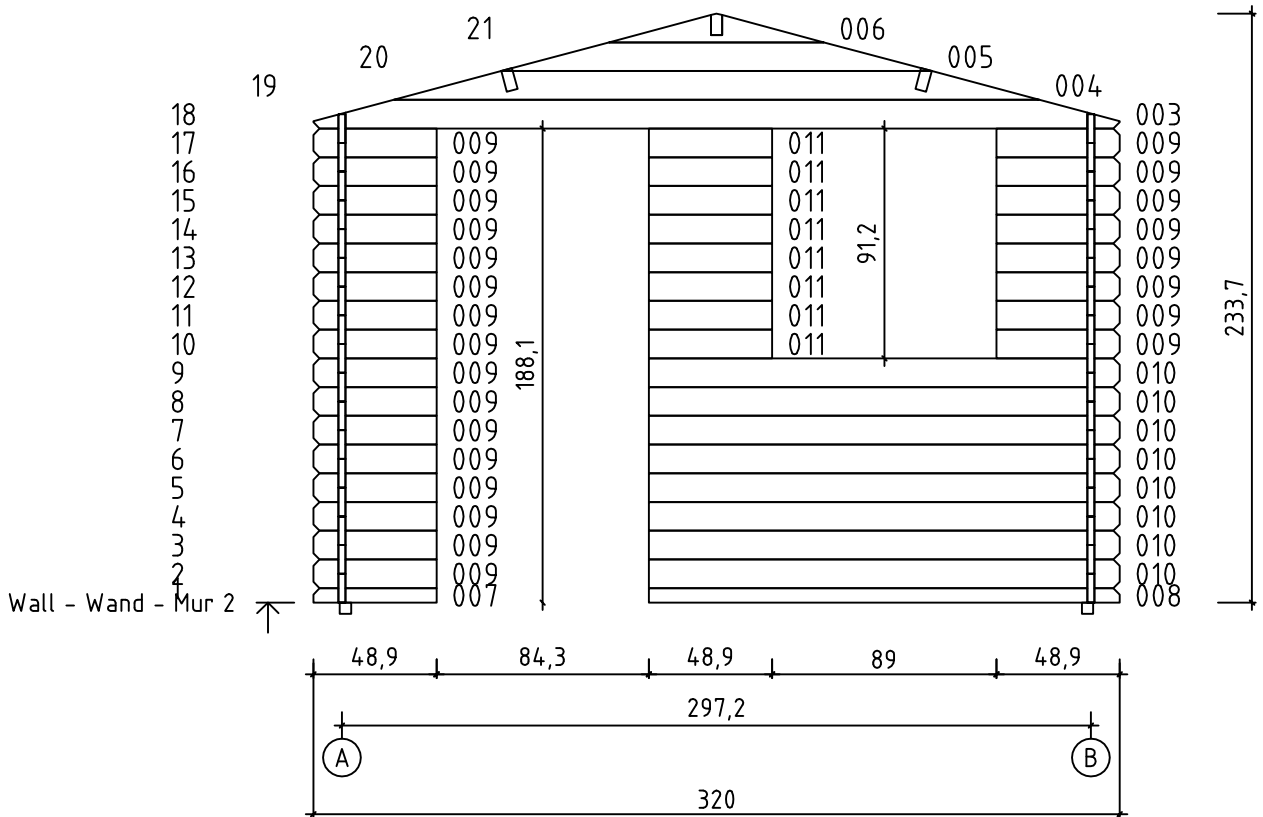
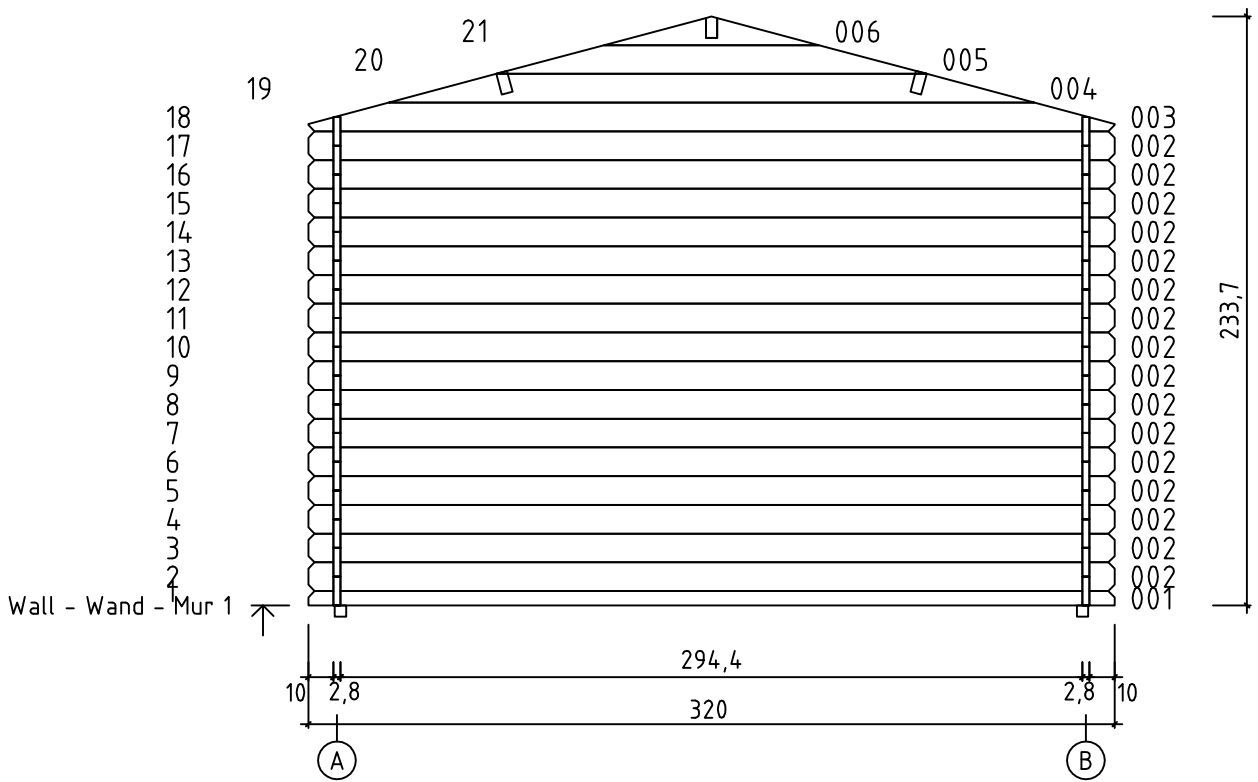



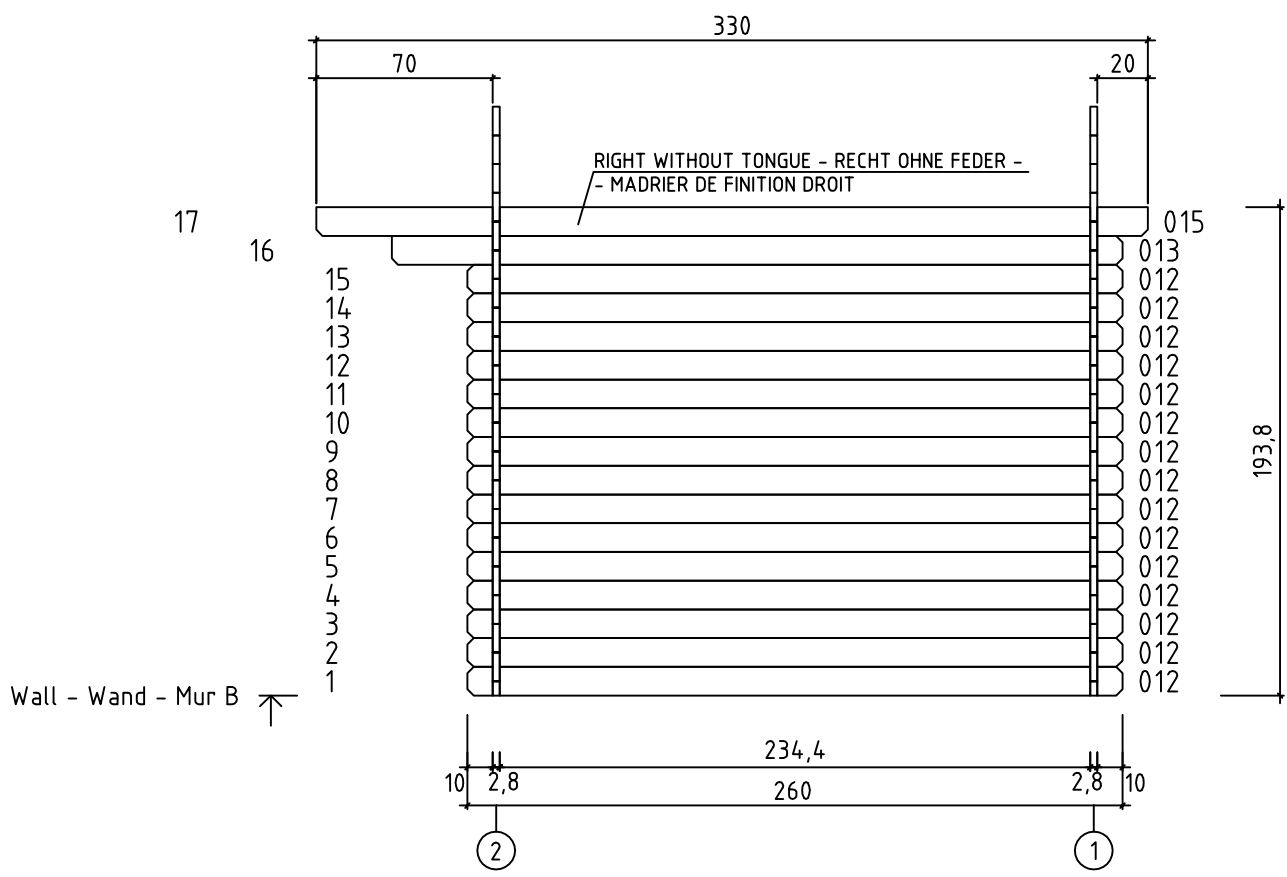
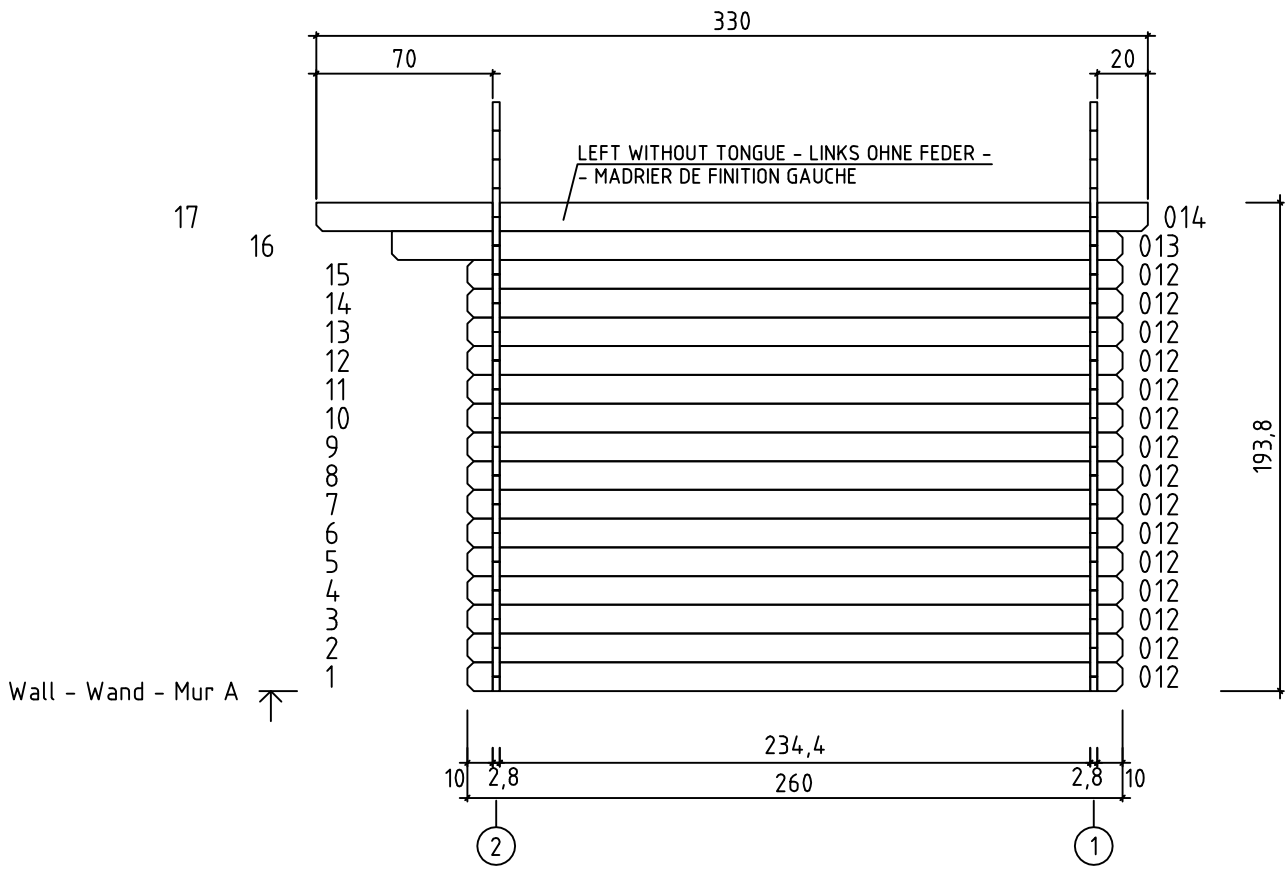

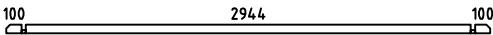
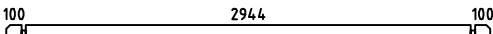

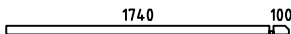

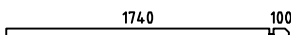

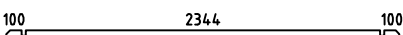
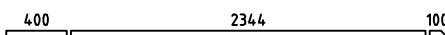
3/8

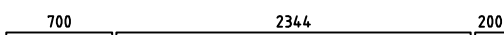
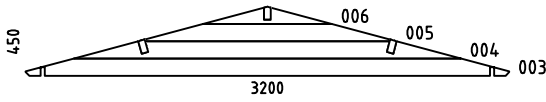
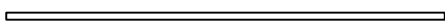



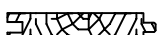
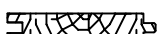

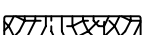

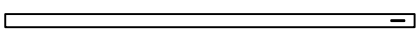
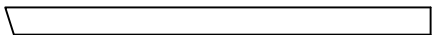

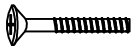

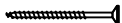
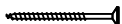
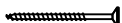
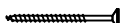

Art.Nr. 280400



Art.Nr. 280400

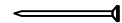
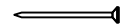
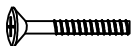

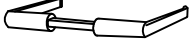
Pos	14.10.2014	Piecelist - Stücklist - Liste des composants Art.Nr. 280400	6/8	Q.	P. (mm)	L. (mm)
001				1	28x57	3200
002				16	28x114	3200
007				1	28x57	489
008				1	28x57	1868
009				24	28x114	489
010				8	28x114	1868
011				8	28x114	489
012				30	28x114	2600
013				2	28x114	2900
014				1	28x120	3300
015				1	28x120	3300
W1-1 W2-1				1 1		
IAR2	FOUNDATION - FUNDAMENT - FONDATION 			5	45x45	2900
IAR1	FOUNDATION - FUNDAMENT - FONDATION 			2	45x45	2390
PR1	ROOF BEAM - DACHBALKEN - PANNE DE TOIT 			1	44x120	3300
A-PR1	ROOF BEAM - DACHBALKEN - PANNE DE TOIT 			2	44x120	3300
	FLOOR BOARDS - FUSSBODENBRETT - LAME DE PLANCHER 			33	90x18	2340
	ROOF BOARDS - DACHBRETT - VOLIGES 			74	90x18	1800
	FLOOR FILLET - FUSSBODENLEISTE - CORNIERE DE FINITION DU PLANCHER 				18x18	10.56
	ROOFING FELT FILLET - DACHPAPPENLEISTE - BAGUETTE DE FIXATION DU FEUTRE BITUMEUX 			4	18x58	1850
	EAVES BOARD - TRAUFBRETT - BANDEAU DE TOIT 			2	18x90	3300
	ROOF EDGE REINFORCEMENT - DACHRANDVERSTÄRKUNG - CORNIERE DE RENFORT DE BORD DE TOIT 			2	28x34	3300
	STORM PROTECTION - STURMLEISTE - - LATTE ANTI-TEMPETE 			4	22x45	1900
	GABLE MOULDING - GIEBELLEISTE - - PLANCHE DE RIVE 			4	18x120	1850

Pos	14.10.2014	Piecelist - Stücklist - Liste des composants Art.Nr. 280400	7/8	Q.	P. (mm)	L. (mm)
		WINDOW HANDLE FITTINGS - FENSTERGRIFF - POIGNÉE D'OUVERTURE DE FENETRE		1		
		BOLT FOR WINDOW HANDLE FITTINGS - BOLZEN FÜR FENSTERGRIFF BESCHLAG - BOULON POUR POIGNÉE D'OUVERTURE DE FENETRE		2		
		SCREW FOR GEORGIAN BARS - SCHRAUBE FÜR SPROSSEN - VIS DE BARRES GEORGIENNE		14	2.5x20	
		SCREW FOR GABLE SEGMENT - SCHRAUBEN FÜR DECKBLATT - VIS POUR FIXATION LOSANGE DE FINITION		4	3.5x35	
		SCREW FOR GABLE MOULDING - SCHRAUBEN FÜR GIEBELLEISTE - VIS DE FIXATION POUR PLANCHE DE RIVE		24	3.5x50	
		SCREW FOR EAVES BOARDS - SCHRAUBEN FÜR TRAUFBRETTER - VIS DE FIXATION POUR BANDEAU DE TOIT		16	4x40	
		SCREW FOR ROOF EDGE REINFORCEMENT - SCHRAUBEN FÜR DACHRANDVERSTÄRKUNG - VIS POUR RENFORT DE BORD DE TOIT		16	4x40	
		SCREW FOR ROOF BEAMS - SCHRAUBEN FÜR DACHBALKEN - VIS POUR PANNE DE TOIT		10	5x120	
		SCREW FOR 1. WALL BEAM - SCHRAUBE FÜR 1. BOHLENREIHE - VIS DE FIXATIONS 1ère RANGÉE DE MADRIERS AVEC POUTRELLES DE FONDATIONS		6	5x90	
		SCREW FOR FOUNDATION - SCHRAUBEN ZUR BEFESTIGUNG FUNDAMENT - VIS DE FIXATIONS DES POUTRELLES DE FONDATIONS		10	5x90	
		SCREW FOR DOORSTEP - SCHRAUBEN FÜR SWELLE - VIS DE FIXATION DU SEUIL DE PORTE		2	4.5x65	
		ZN NAIL FOR FLOOR FILLET - ZN NÄGEL FÜR FUSSBODENLEISTE - POINTE POUR CORNIERE DE FINITION DU PLANCHER		22	1.4x40	
		HAMMER BLOCK - SCHLAGHOLZ - CALLE DE FRAPPE		1		
		NUT FOR STORM PROTECTION - SCHRAUBENMUTTER FÜR STURMLEISTE - ÉCROU POUR LAME ANTI-TEMPETE		8	D6	
		ZN NAIL FOR ROOFING FELT FILLET - ZN NÄGEL FÜR DACHPAPPENLEISTE - POINTE POUR BAGUETTE FIXATION FEUTRE BITUMEUX		20	2x40	
		ZN NAIL FOR ROOF - ZN NÄGEL FÜR DACHBRETTER - POINTES DE FIXATIONS DES VOLIGES DE TOIT		236	2x50	
		ZN NAIL FOR FLOOR - ZN NÄGEL FÜR FUSSBODENBRETTER - CLOUS POUR PLANCHER		170	2x50	
		BOLT FOR STORM PROTECTION - BOLZEN FÜR STURMLEISTE - VIS POUR LAME ANTI-TEMPETE		8	6x60	
		GABLE SEGMENT - DECKBLATT - LOSANGE DE FINITION		2		
		WASHER FOR STORM PROTECTION - DICHTSCHEIBE FÜR STURMLEISTE - RONDELLE POUR LAME ANTI-TEMPETE		8	D6	
		DOOR HANDLE FITTINGS - TÜRGRIFF - SET DE GARNITURES DE SERRURE DE PORTE		1		
		SET OF DOOR LOCK COVERS - SCHLOSSBLENDEN - SET DE GARNITURES DE SERRURE DE PORTE		1		
		CYLINDER LOCK - ZYLINDERSCHLOSS - CYLINDRE DE SERRURE		1	30/35	

