

Aruba 3A
Art. Nr. 4014600
1/19

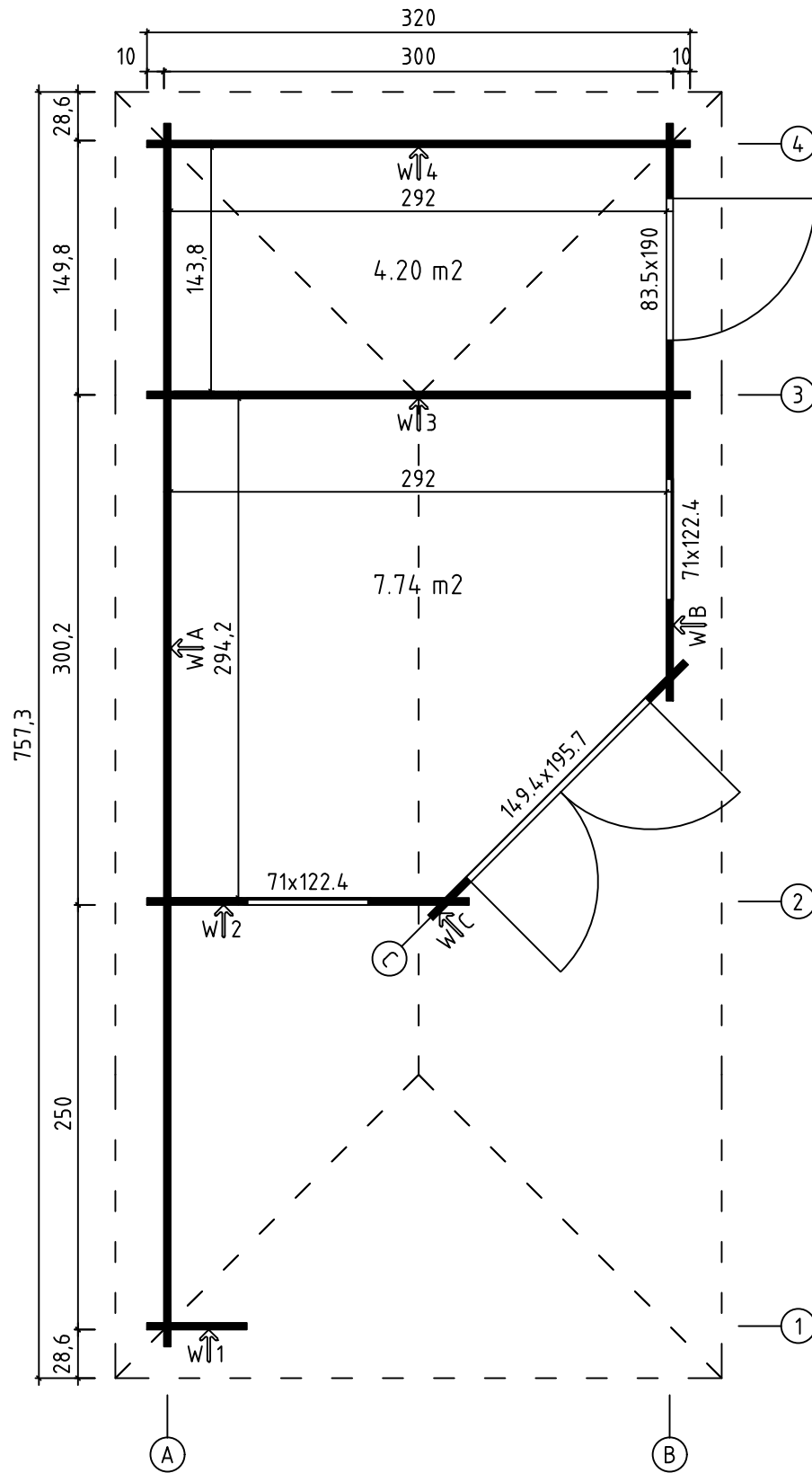

01.02.2018

Groundplan - Grundplan - Plan de masse - Planimetria -
Plattegrond - Põhiplaan



Foundation - Fundament - Fondation - Fundamenta -
Fundering - Immutatud alusraam

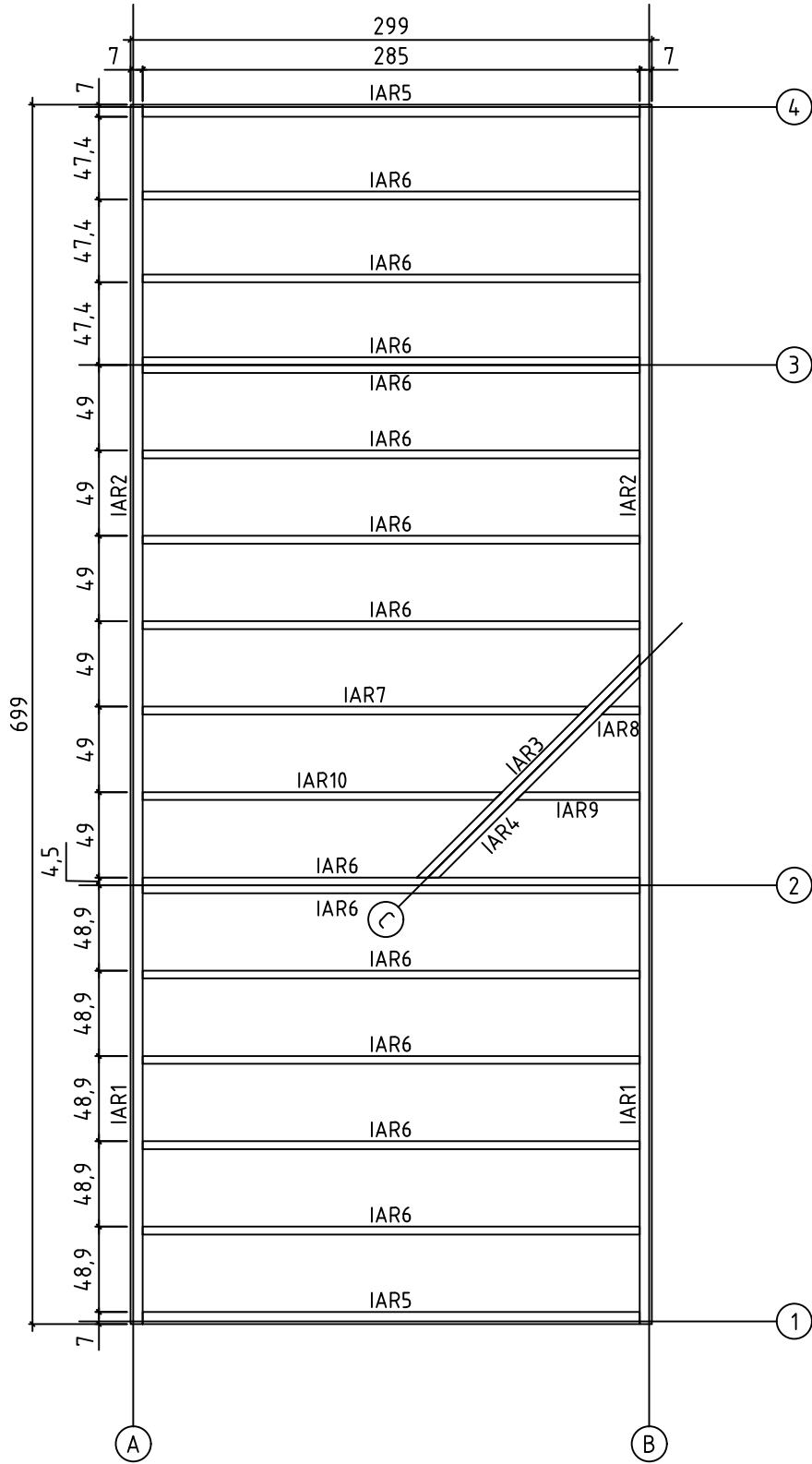

Floor boards - Fussbodenbretter - Plan pose plancher -
Pavimento - Vloerhout - Põrandalaudis

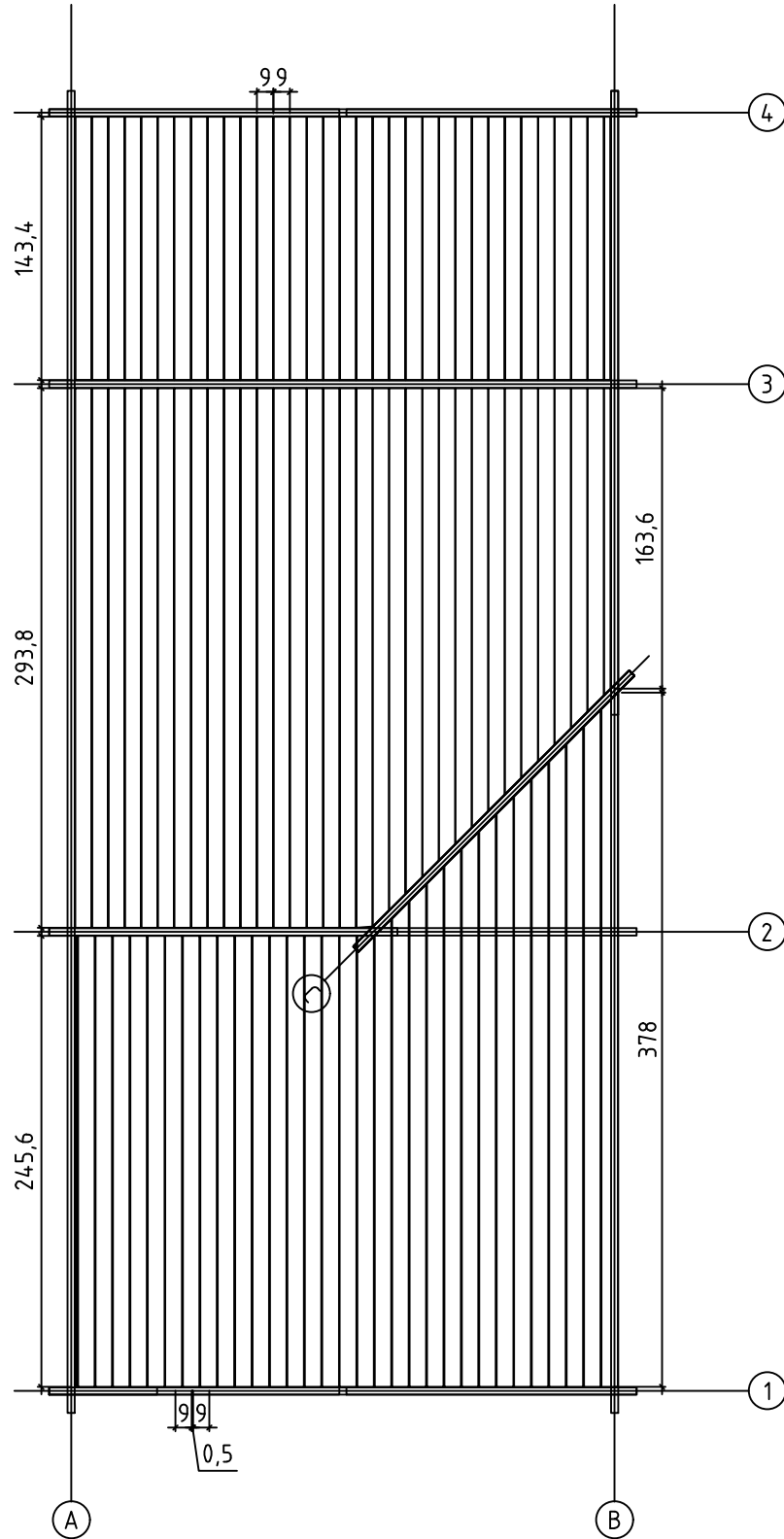

Terrace boards - Terrassenbretter - Plancher de terrasse -
Piattaforme terrazzo - Terrasvloer - Terrassilaudis

Overhead beams - Deckenbalken - Solives - Travi a vista -
Overlopende balken - Laetalade konstruksioon

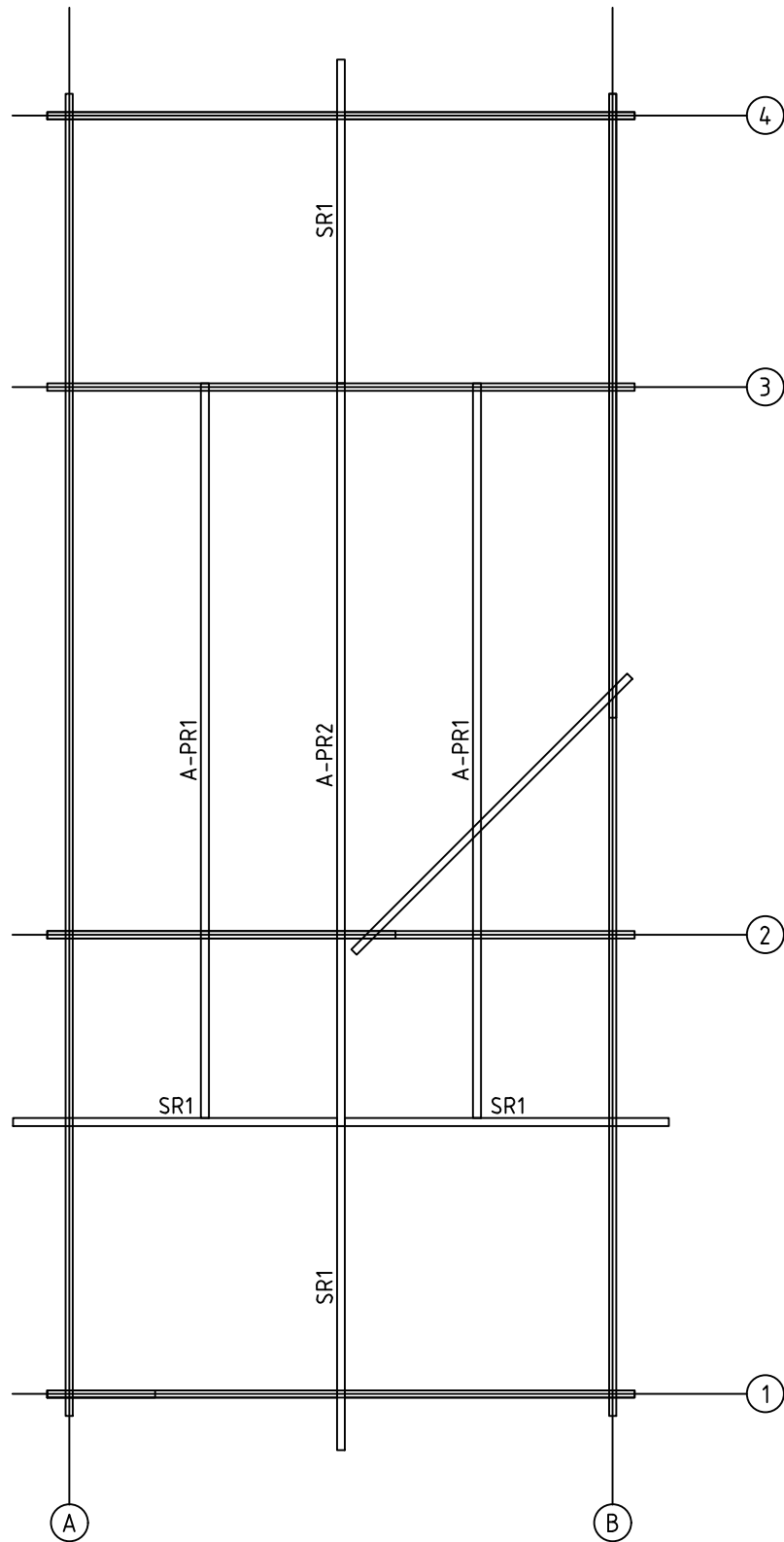

Diagonals must be equal - Prüfung diagonale Austrichtung -
Controle des diagonales - Le diagonali devono essere eguali -
Gelijkbenige diagonaal - Diagonaalid peavad olema võrdsed
 $A=B; C=D; E=F$

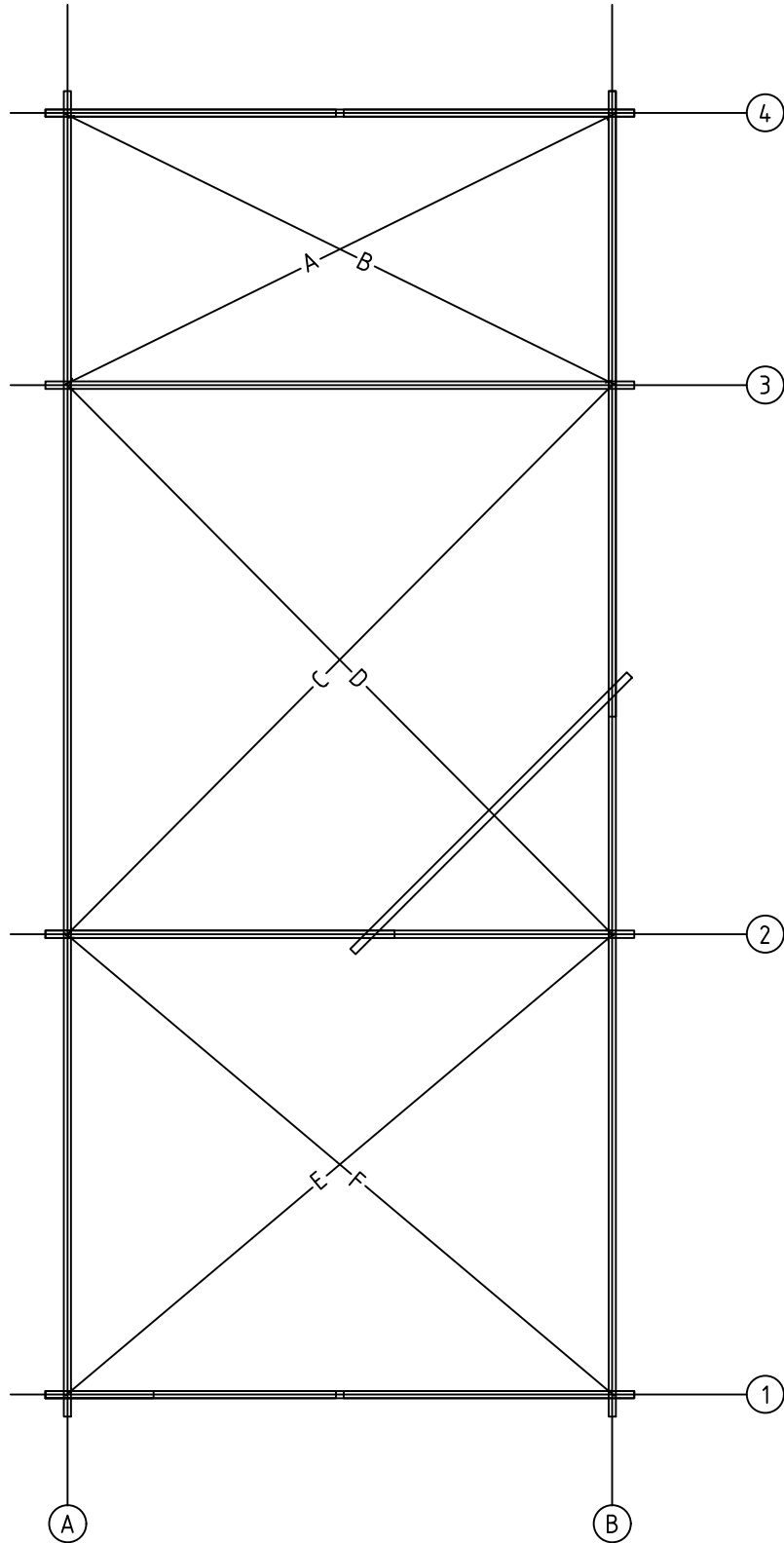

Art. Nr. 4014600

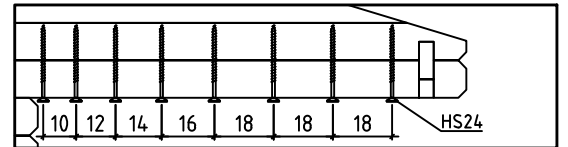
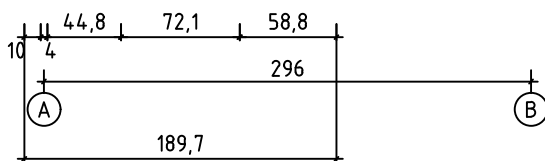
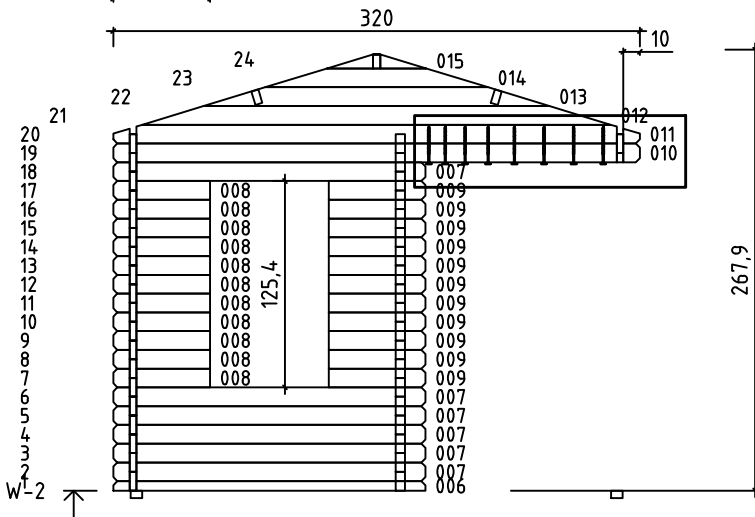
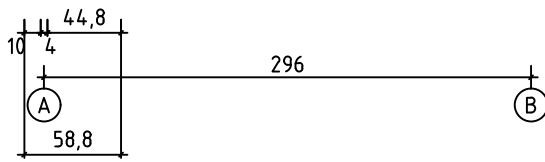
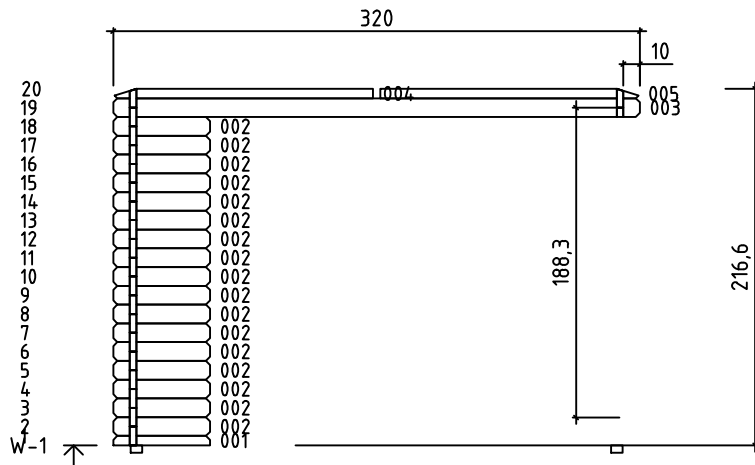

To prevent splits in the wood, pre-drilling screw holes ($\phi 5$) is needed

Um der Rissbildung im Holz vorzubeugen, ist es notwendig die Schraubenlöcher mit einem Diameter von 5 mm vorzubohren.

Afin d'éviter le risque de fissuration du bois c'est obligatoire de percer auparavant les trous des vis de diamètres 5mm.

Per evitare di rompere il legno, prima di avvitare la vite autofilettante, preparare la sede con un foro ($\phi 5$).

Om te voorkomen dat het hout splijt, is het nodig om de schroefgaten voor te boren ($\phi 5$)

Puidulõhede vältimiseks on vajalik kruviaukude ettepuurimine ($\phi 5$).

Art. Nr. 4014600

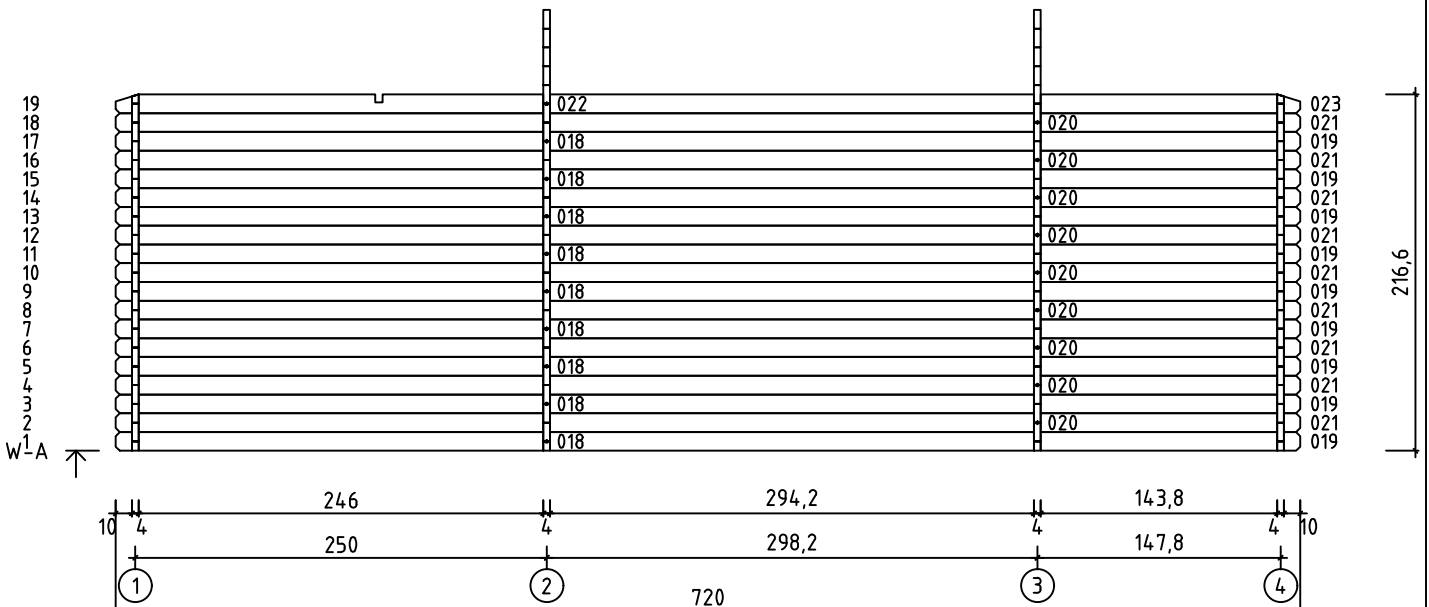
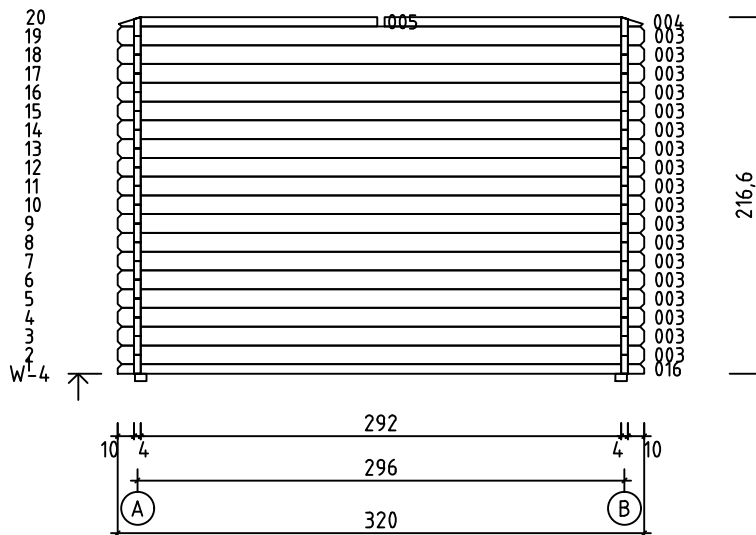
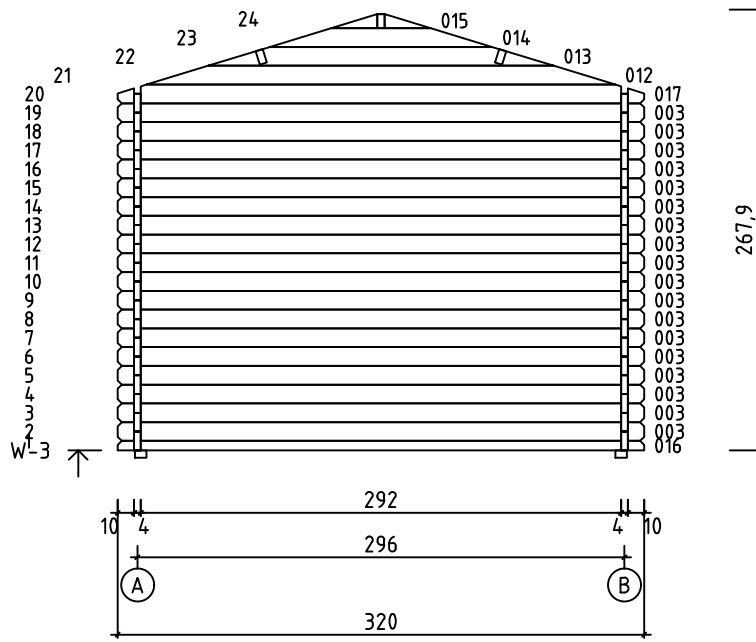

Art. Nr. 4014600

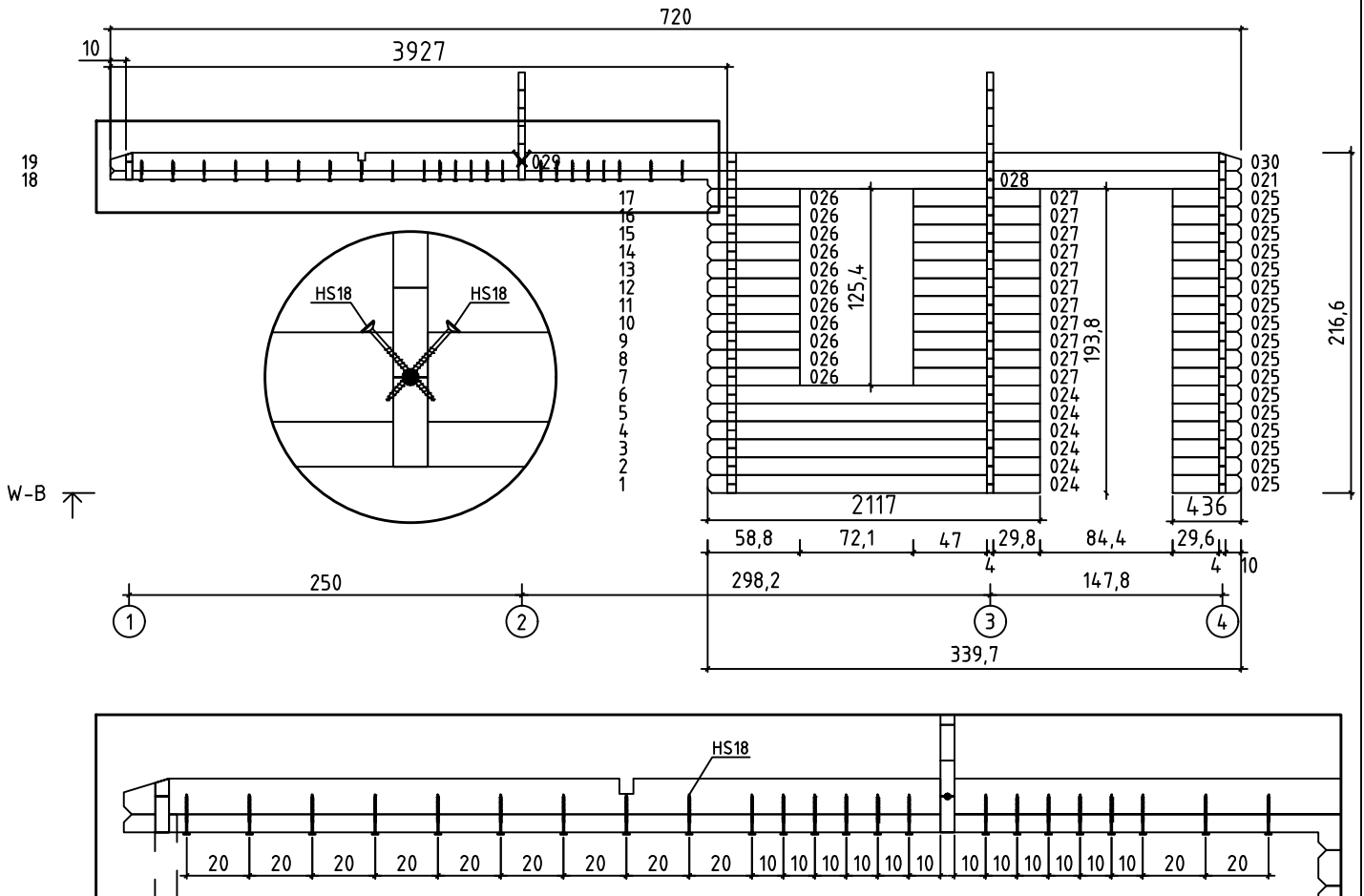

To prevent splits in the wood, pre-drilling screw holes ($\phi 5$) is needed
 Um der Rissbildung im Holz vorzubeugen, ist es notwendig die Schraubenlöcher mit einem Diameter von 5 mm vorzubohren.

Afin d'éviter le risque de fissuration du bois c'est obligatoire de percer auparavant les trous des vis de diamètres 5mm.

Per evitare di rompere il legno, prima di avvitarre la vite autofilettante, preparare la sede con un foro ($\phi 5$).

Om te voorkomen dat het hout splijt, is het nodig om de schroefgaten voor te boren ($\phi 5$)

Puidulõhede vältimiseks on vajalik kruviaukude ettepuurimine ($\phi 5$).

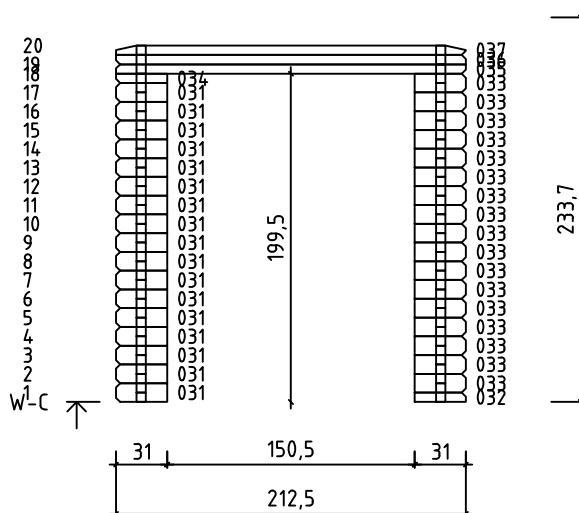

Art. Nr. 4014600

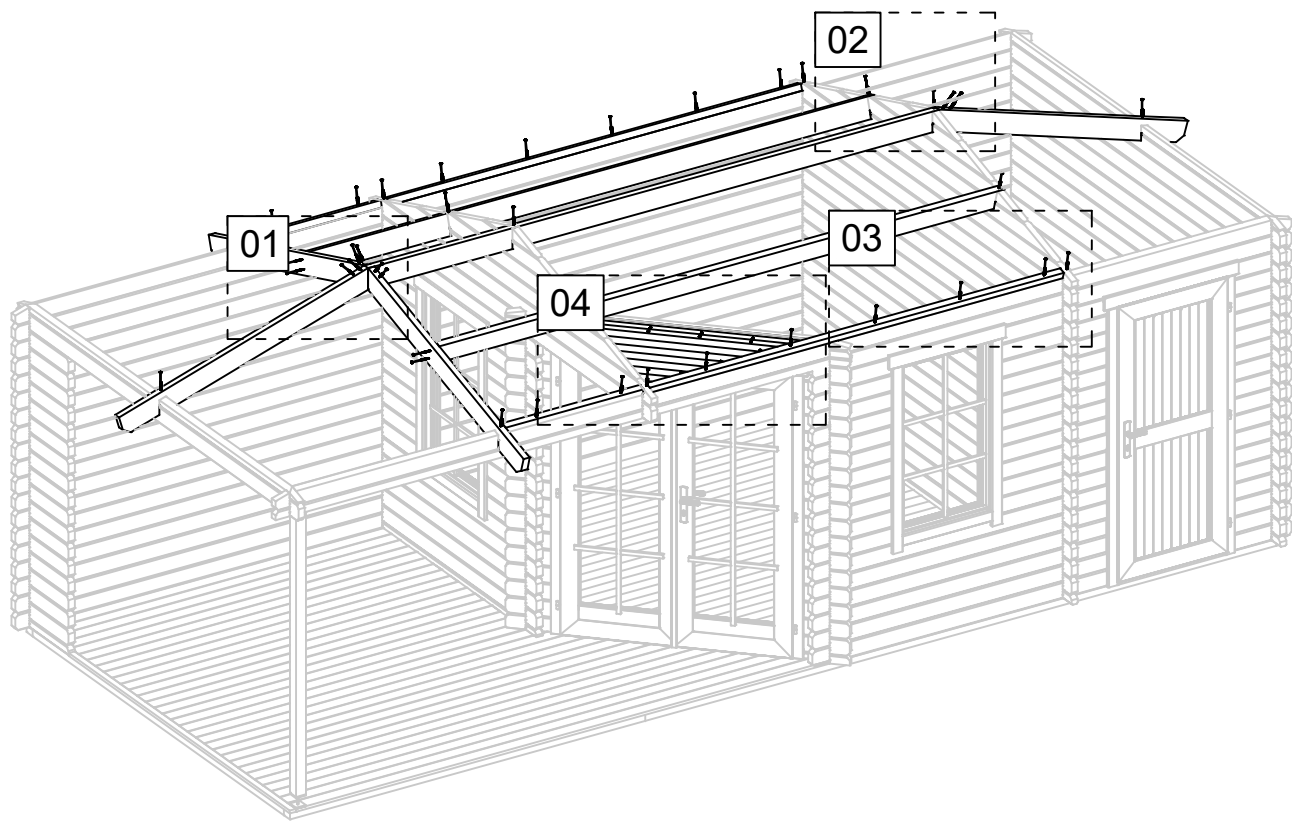

01

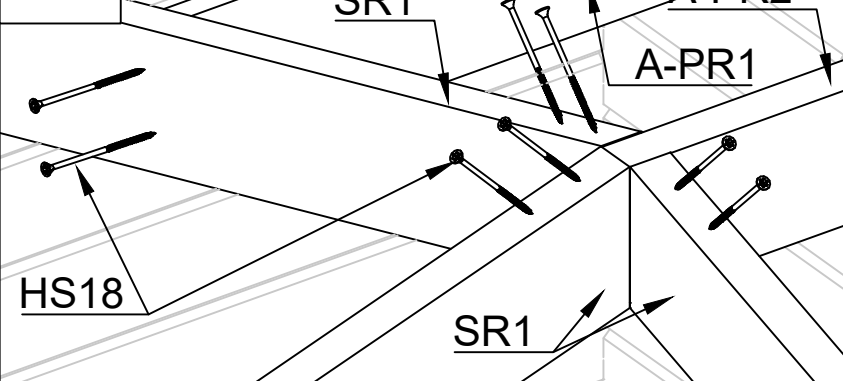

02

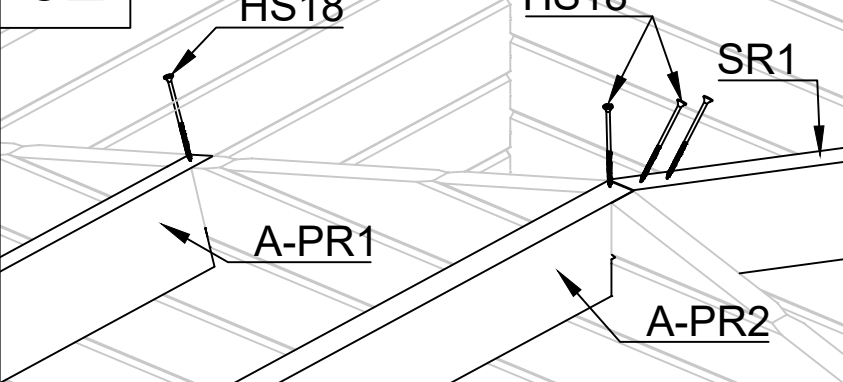

04

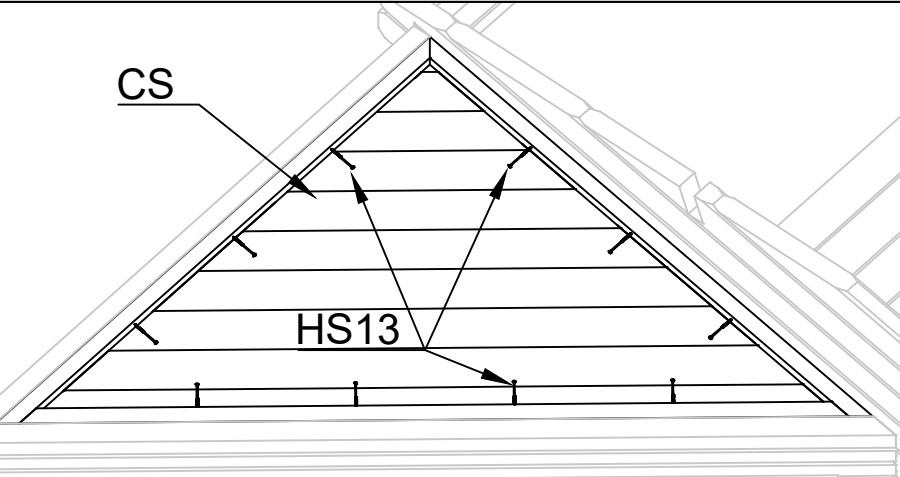

03

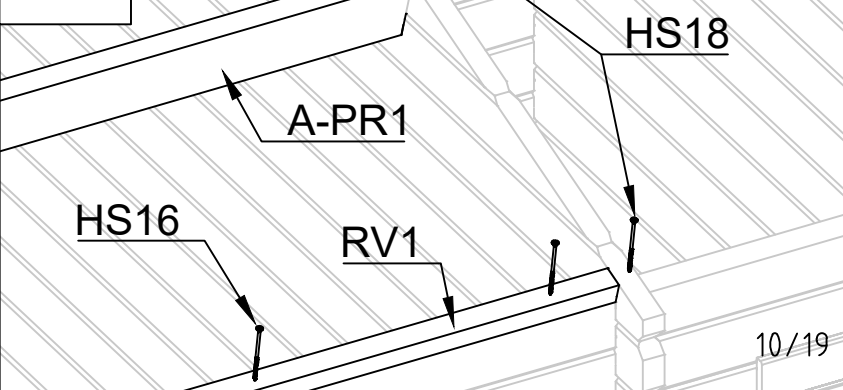

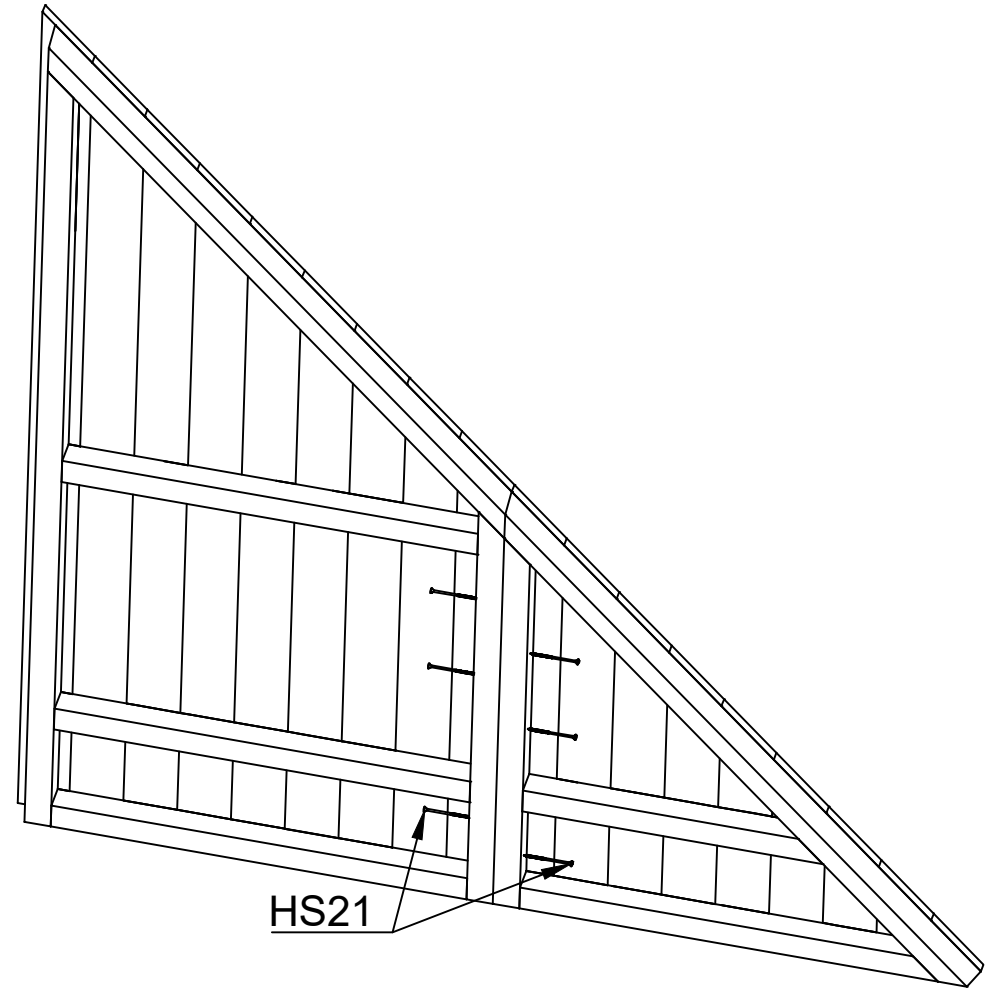
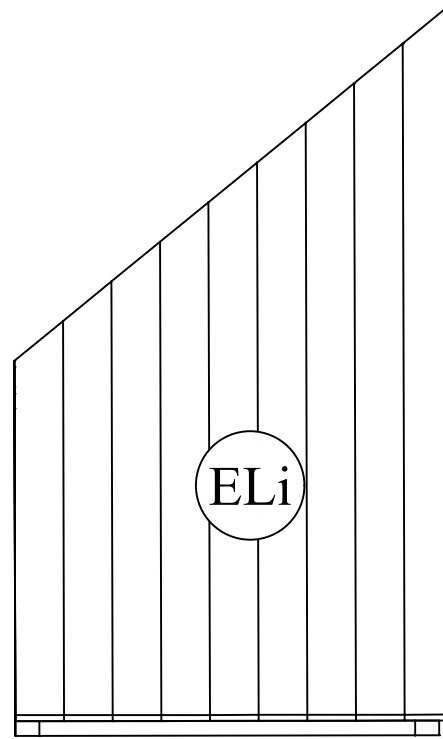
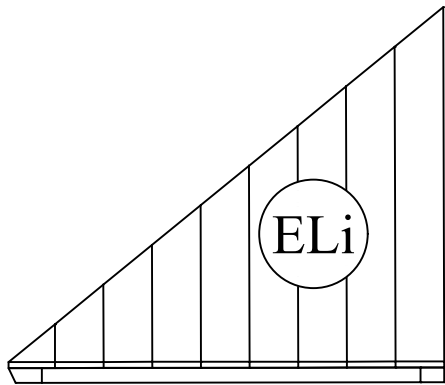

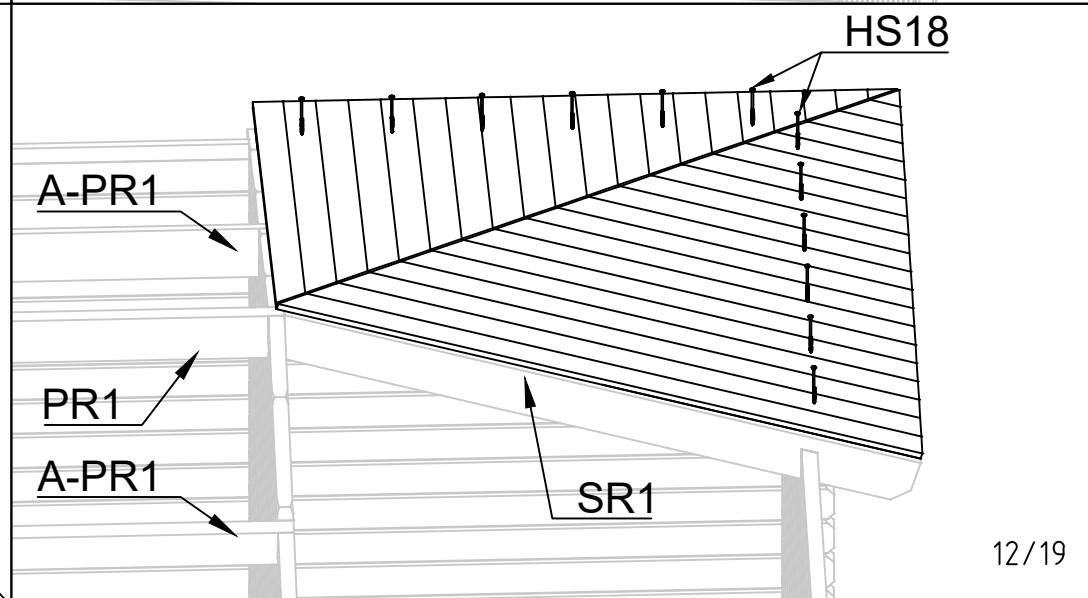
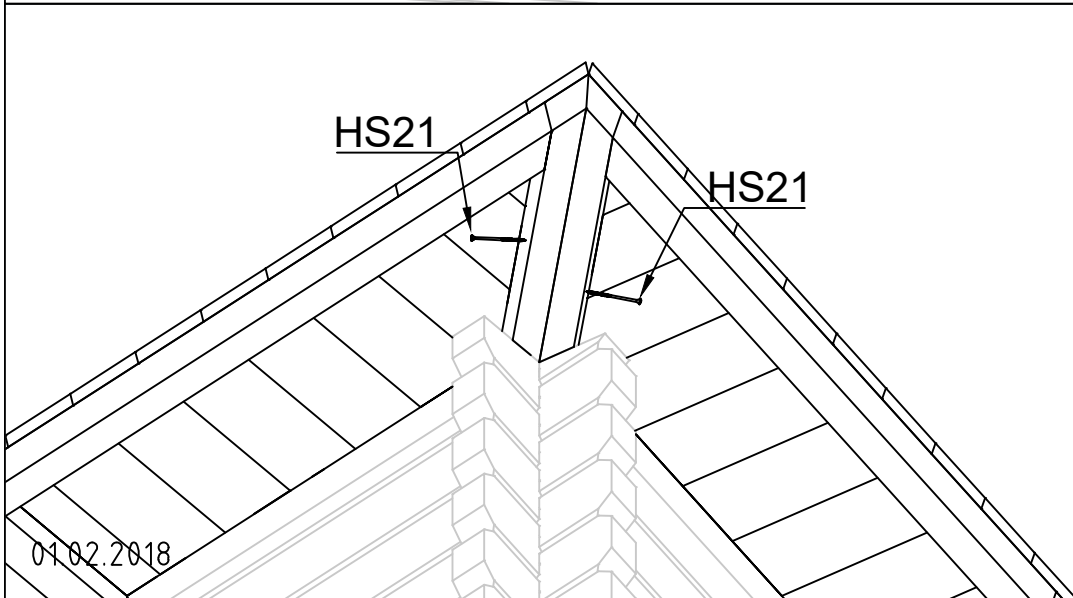
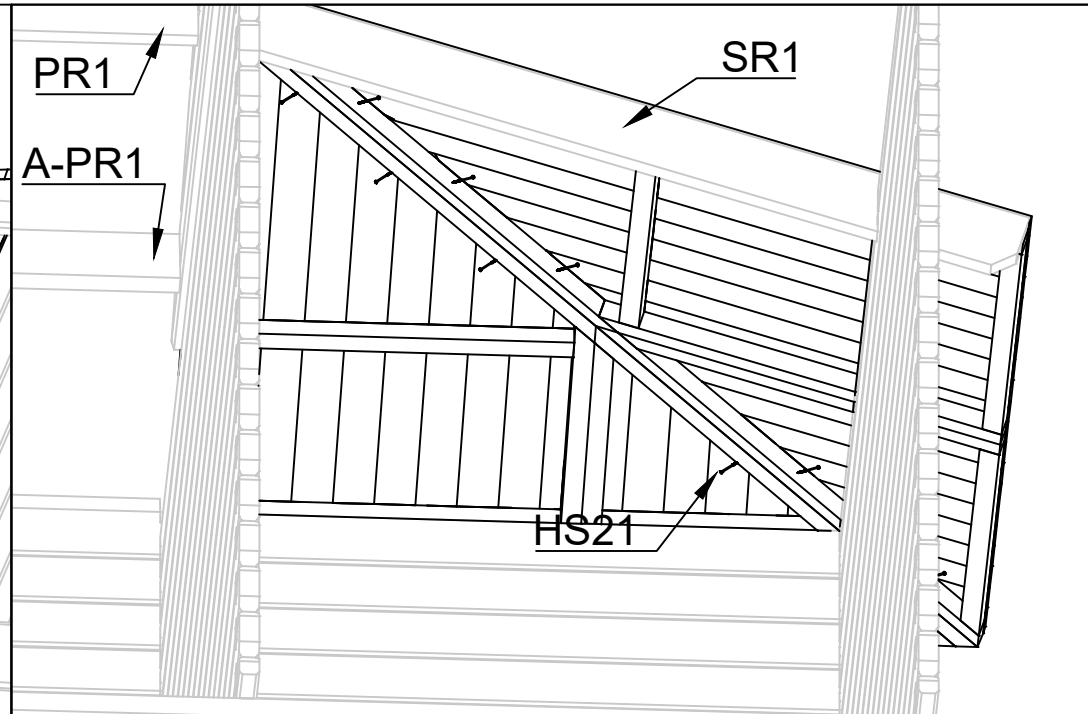
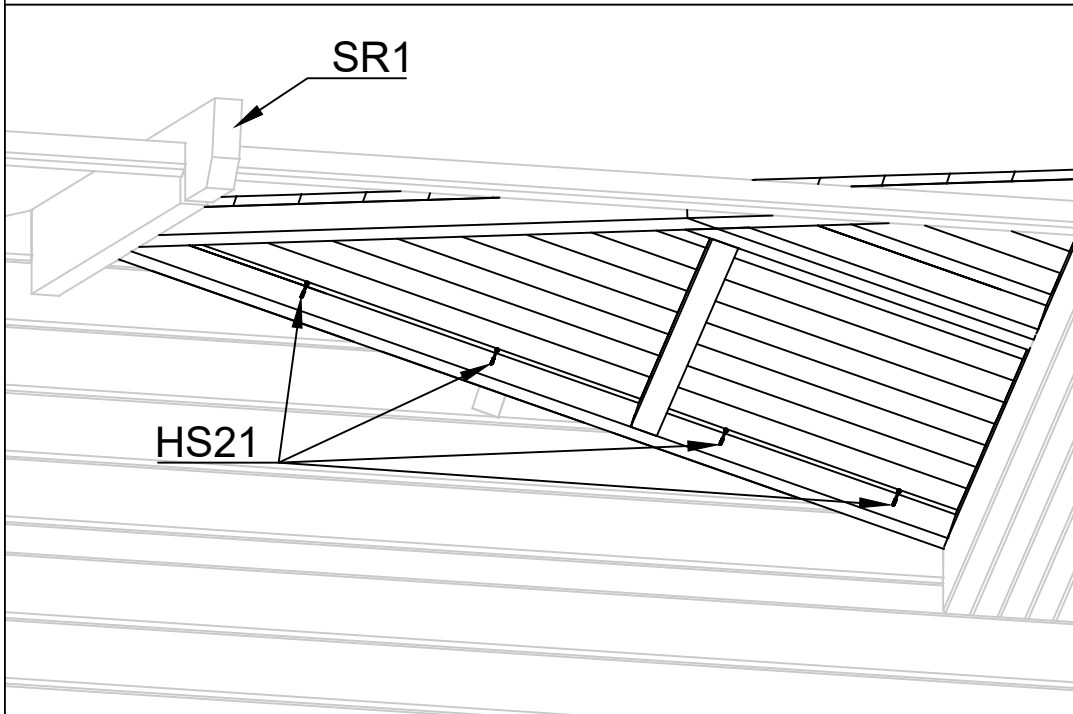

1

Art. Nr. 4014600

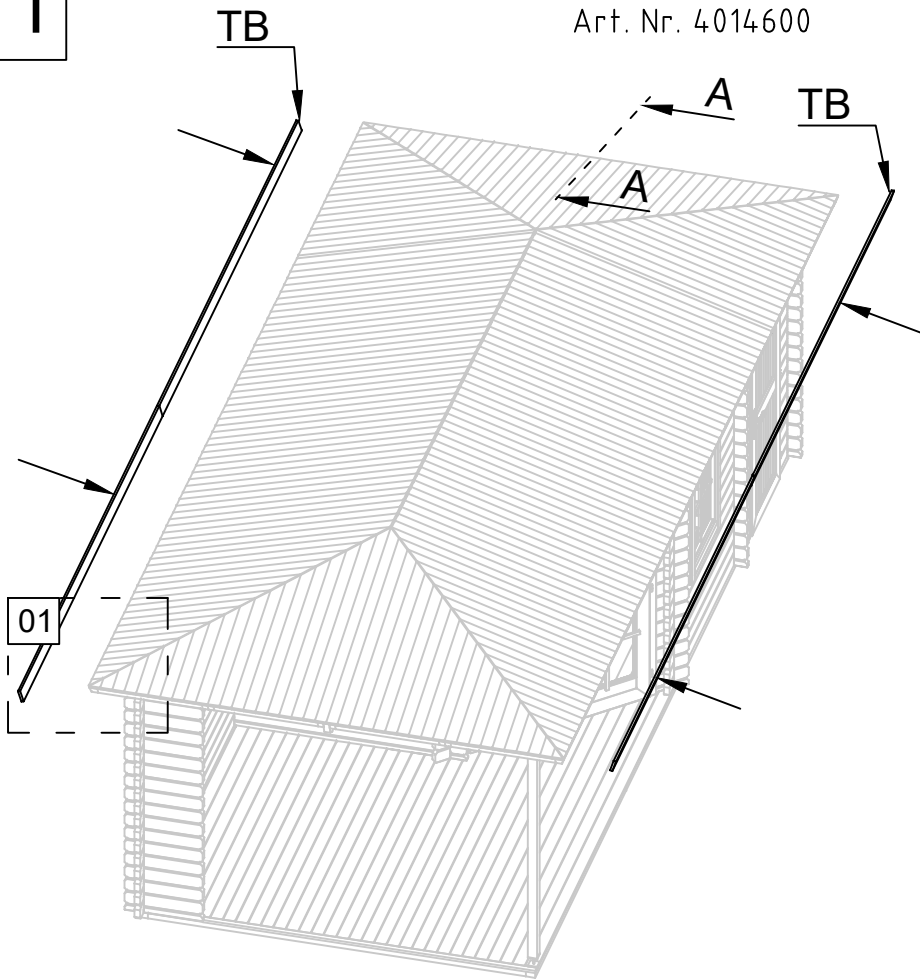

A-A

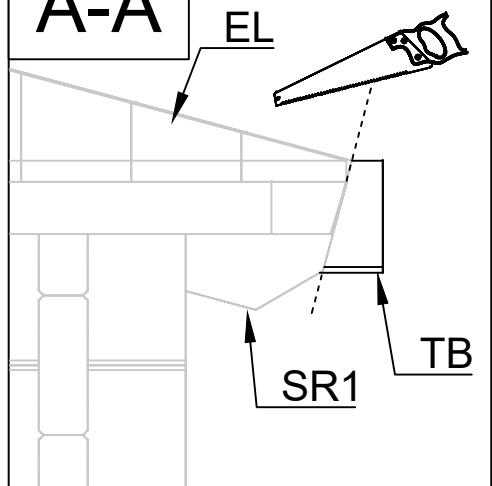

01

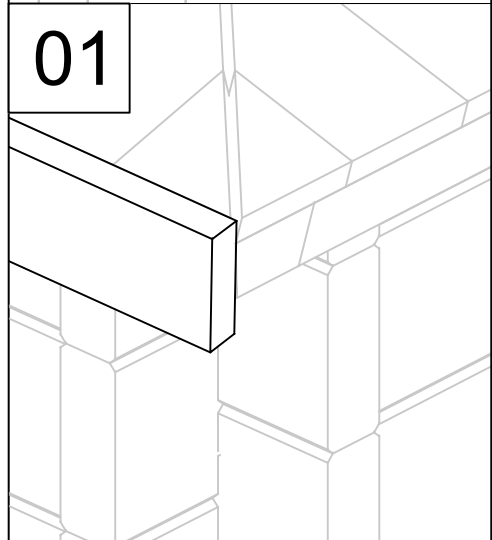

2

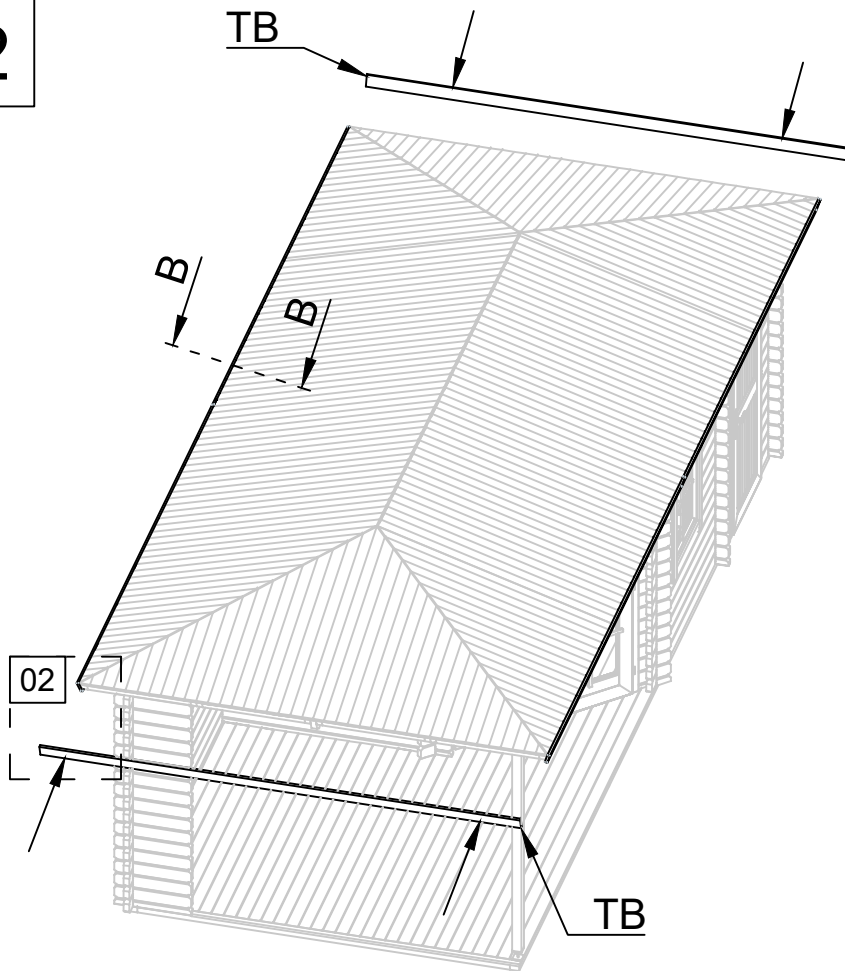



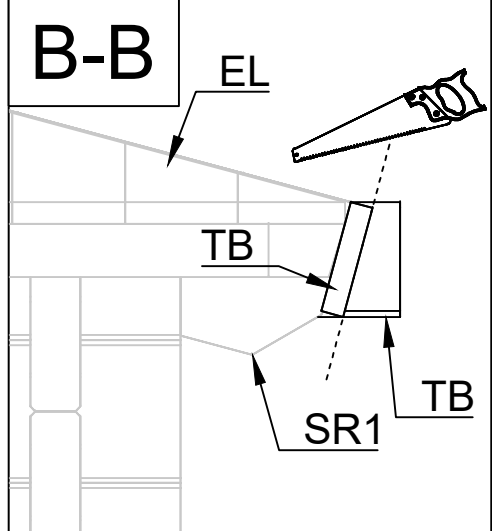



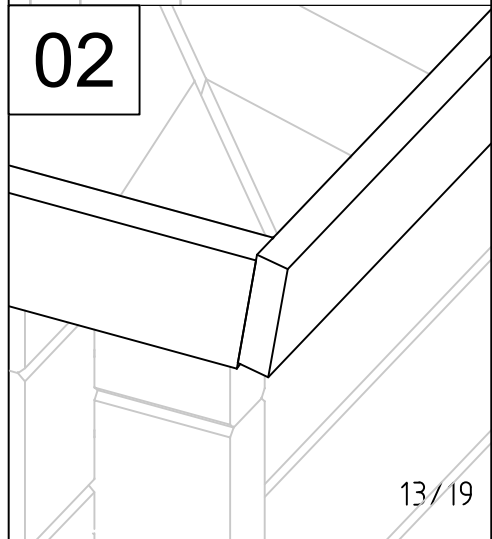



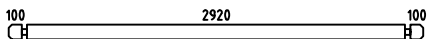
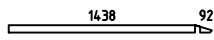
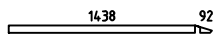
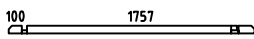
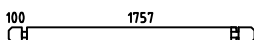

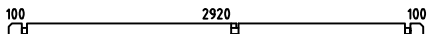
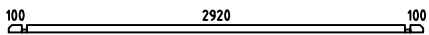
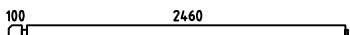
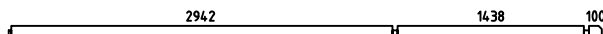

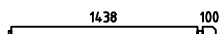
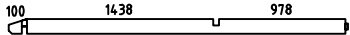
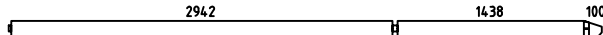
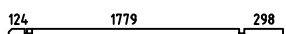

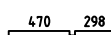
B-B

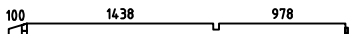

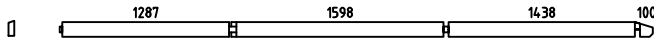



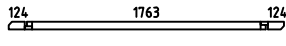
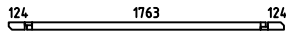
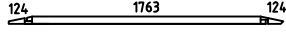
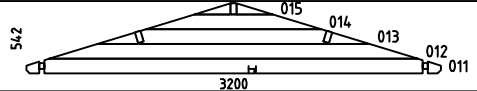
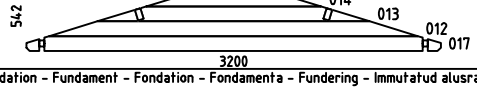
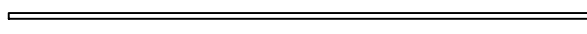
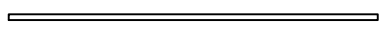
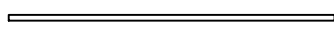
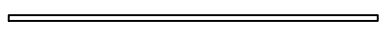
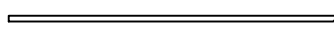
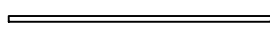
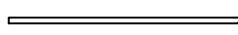
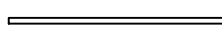

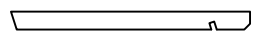
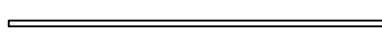
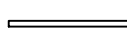

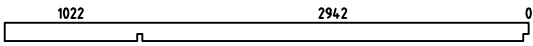
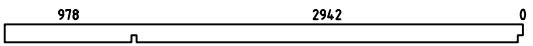

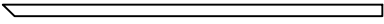
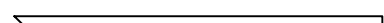
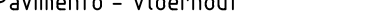

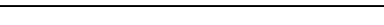
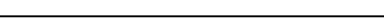
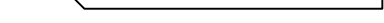
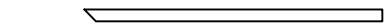
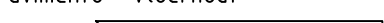
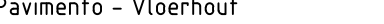
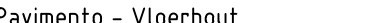

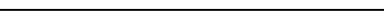
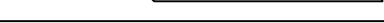
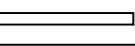



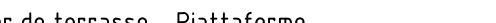

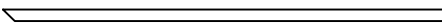
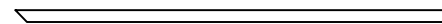
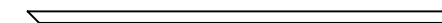
02

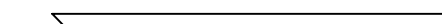

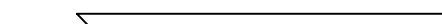



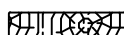
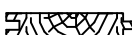
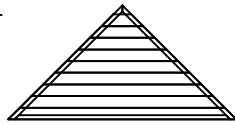
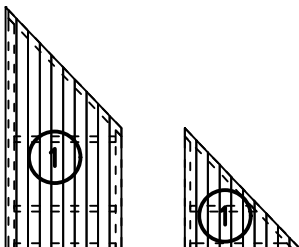
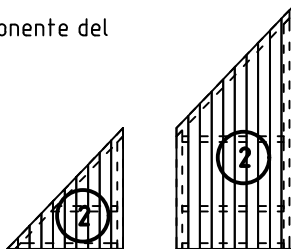

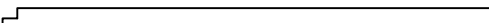
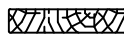

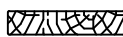

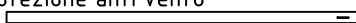











Pos	01.02.2018 Piece list - Stückliste - Liste des pièces - Elementi - Stuklijst - Tükítabel Art. Nr. 4014600 14/19	Q	P (mm)	L (mm)
001		1	40x57	588
002		17	40x114	588
003		37	40x114	3200
004		2	40x57	1570
005		2	40x57	1570
006		1	40x57	1897
007		6	40x114	1897
008		11	40x114	588
009		11	40x114	588
010		1	40x114	3200
016		2	40x57	3200
018		9	40x114	2620
019		9	40x114	4580
020		9	40x114	5602
021		10	40x114	1598
022		1	40x114	2620
023		1	40x114	4580
024		6	40x114	2118
025		17	40x114	436
026		11	40x114	588
027		11	40x114	808
028		1	40x114	5602
029		1	40x114	2620

Pos	01.02.2018 Piece list - Stückliste - Liste des pièces - Elementi - Stuklijst - Tükítabel Art. Nr. 4014600 15/19	Q	P (mm)	L (mm)
030		1	40x114	4580
031		17	40x114	310
032		1	40x57	310
033		17	40x114	310
034		1	40x57	310
035		1	40x57	2125
036		1	40x57	2125
037		1	40x57	2125
W2-1		1		
W3-1		1		
IAR2	Foundation - Fundament - Fondation - Fondamenta - Fundering - Immutatud alusraam 	2	70x45	4475
IAR5	Foundation - Fundament - Fondation - Fondamenta - Fundering - Immutatud alusraam 	2	70x45	2850
IAR1	Foundation - Fundament - Fondation - Fondamenta - Fundering - Immutatud alusraam 	2	70x45	2515
IAR6	Foundation - Fundament - Fondation - Fondamenta - Fundering - Immutatud alusraam 	13	45x45	2850
IAR7	Foundation - Fundament - Fondation - Fondamenta - Fundering - Immutatud alusraam 	1	45x45	2550
IAR10	Foundation - Fundament - Fondation - Fondamenta - Fundering - Immutatud alusraam 	1	45x45	2061
IAR3	Foundation - Fundament - Fondation - Fondamenta - Fundering - Immutatud alusraam 	1	45x45	1810
IAR4	Foundation - Fundament - Fondation - Fondamenta - Fundering - Immutatud alusraam 	1	45x45	1720
IAR9	Foundation - Fundament - Fondation - Fondamenta - Fundering - Immutatud alusraam 	1	45x45	707
IAR8	Foundation - Fundament - Fondation - Fondamenta - Fundering - Immutatud alusraam 	1	45x45	218
SR1	Rafter - Dachsparren - Chevron - Trave - Dak spar - Sarikas 	4	44x140	1845
RV2	Lath - Pfetten - Liteau - Piccola asse - Gordingen - Roov 	2	44x44	2942
RV1	Lath - Pfetten - Liteau - Piccola asse - Gordingen - Roov 	2	44x44	978





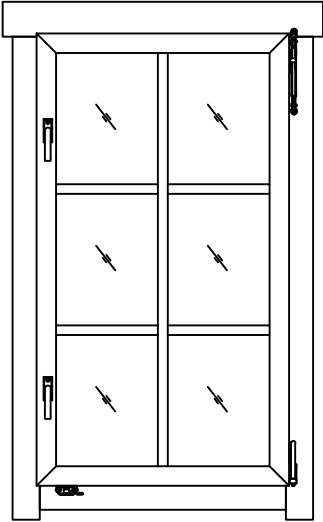
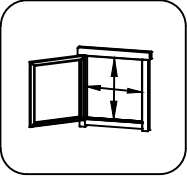
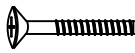
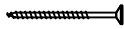

Pos	01.02.2018 Piece list - Stückliste - Liste des pièces - Elementi - Stuklijst - Tükítabel Art. Nr. 4014600 16/19	Q	P (mm)	L (mm)
A-PR2	Roof beam - Dachbalken - Panne de toit - Perlina del tetto - Gordingen / dakbalk - Pärlin 	1	44x140	4044
A-PR1	Roof beam - Dachbalken - Panne de toit - Perlina del tetto - Gordingen / dakbalk - Pärlin 	2	44x140	4000
	Floor boards - Fussbodenbretter - Lamé de plancher - Pavimento - Vloerhout - Pörandalaud 	18	90x18	2938
	Floor boards - Fussbodenbretter - Lamé de plancher - Pavimento - Vloerhout - Pörandalaud 	1	90x18	2931
	Floor boards - Fussbodenbretter - Lamé de plancher - Pavimento - Vloerhout - Pörandalaud 	1	90x18	2841
	Floor boards - Fussbodenbretter - Lamé de plancher - Pavimento - Vloerhout - Pörandalaud 	1	90x18	2751
	Floor boards - Fussbodenbretter - Lamé de plancher - Pavimento - Vloerhout - Pörandalaud 	1	90x18	2661
	Floor boards - Fussbodenbretter - Lamé de plancher - Pavimento - Vloerhout - Pörandalaud 	1	90x18	2571
	Floor boards - Fussbodenbretter - Lamé de plancher - Pavimento - Vloerhout - Pörandalaud 	1	90x18	2481
	Floor boards - Fussbodenbretter - Lamé de plancher - Pavimento - Vloerhout - Pörandalaud 	1	90x18	2391
	Floor boards - Fussbodenbretter - Lamé de plancher - Pavimento - Vloerhout - Pörandalaud 	1	90x18	2301
	Floor boards - Fussbodenbretter - Lamé de plancher - Pavimento - Vloerhout - Pörandalaud 	1	90x18	2211
	Floor boards - Fussbodenbretter - Lamé de plancher - Pavimento - Vloerhout - Pörandalaud 	1	90x18	2121
	Floor boards - Fussbodenbretter - Lamé de plancher - Pavimento - Vloerhout - Pörandalaud 	1	90x18	2031
	Floor boards - Fussbodenbretter - Lamé de plancher - Pavimento - Vloerhout - Pörandalaud 	1	90x18	1941
	Floor boards - Fussbodenbretter - Lamé de plancher - Pavimento - Vloerhout - Pörandalaud 	1	90x18	1851
	Floor boards - Fussbodenbretter - Lamé de plancher - Pavimento - Vloerhout - Pörandalaud 	1	90x18	1761
	Floor boards - Fussbodenbretter - Lamé de plancher - Pavimento - Vloerhout - Pörandalaud 	1	90x18	1671
	Floor boards - Fussbodenbretter - Lamé de plancher - Pavimento - Vloerhout - Pörandalaud 	33	90x18	1434
	Terrace boards - Terrassenbretter - Plancher de terrasse - Piattaforme terrazzo - Terrasvloer - Terrassilaud 	1	90x19	3780
	Terrace boards - Terrassenbretter - Plancher de terrasse - Piattaforme terrazzo - Terrasvloer - Terrassilaud 	1	90x19	3685
	Terrace boards - Terrassenbretter - Plancher de terrasse - Piattaforme terrazzo - Terrasvloer - Terrassilaud 	1	90x19	3590
	Terrace boards - Terrassenbretter - Plancher de terrasse - Piattaforme terrazzo - Terrasvloer - Terrassilaud 	1	90x19	3495

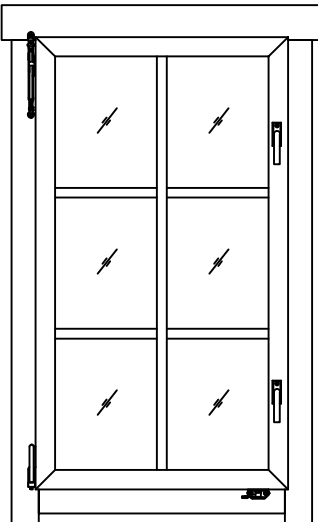
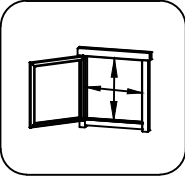
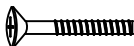
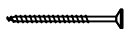

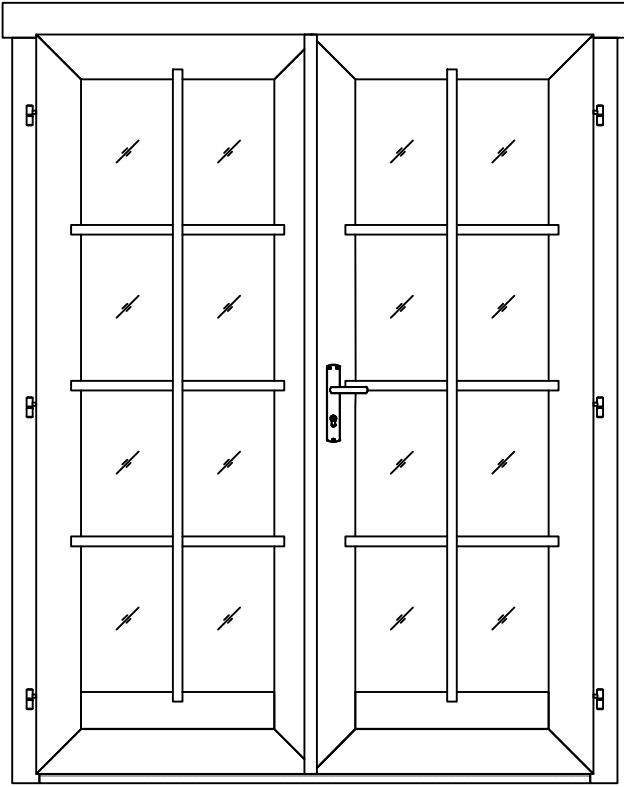
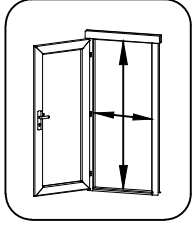
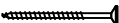
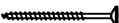
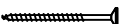

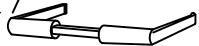
Pos	01.02.2018 Piece list - Stückliste - Liste des pièces - Elementi - Stuklijst - Tükítabel Art. Nr. 4014600 17/19	Q	P (mm)	L (mm)
	Terrace boards - Terrassenbretter - Plancher de terrasse - Piattaforme terrazzo - Terrasvloer - Terrassilaud 	1	90x19	3400
	Terrace boards - Terrassenbretter - Plancher de terrasse - Piattaforme terrazzo - Terrasvloer - Terrassilaud 	1	90x19	3305
	Terrace boards - Terrassenbretter - Plancher de terrasse - Piattaforme terrazzo - Terrasvloer - Terrassilaud 	1	90x19	3210
	Terrace boards - Terrassenbretter - Plancher de terrasse - Piattaforme terrazzo - Terrasvloer - Terrassilaud 	1	90x19	3115
	Terrace boards - Terrassenbretter - Plancher de terrasse - Piattaforme terrazzo - Terrasvloer - Terrassilaud 	1	90x19	3020
	Terrace boards - Terrassenbretter - Plancher de terrasse - Piattaforme terrazzo - Terrasvloer - Terrassilaud 	1	90x19	2925
	Terrace boards - Terrassenbretter - Plancher de terrasse - Piattaforme terrazzo - Terrasvloer - Terrassilaud 	1	90x19	2830
	Terrace boards - Terrassenbretter - Plancher de terrasse - Piattaforme terrazzo - Terrasvloer - Terrassilaud 	1	90x19	2735
	Terrace boards - Terrassenbretter - Plancher de terrasse - Piattaforme terrazzo - Terrasvloer - Terrassilaud 	1	90x19	2640
	Terrace boards - Terrassenbretter - Plancher de terrasse - Piattaforme terrazzo - Terrasvloer - Terrassilaud 	1	90x19	2545
	Terrace boards - Terrassenbretter - Plancher de terrasse - Piattaforme terrazzo - Terrasvloer - Terrassilaud 	18	90x19	2456
	Roof boards - Dachbretter - Voliges - Perlina per tetto - Dakhout - Katuselaud 	90	90x18	1868
CS	Ceiling shield - Element - Panneau de toiture - Pannello del soffitto - Plafond bedeking - Laekilp 	1		
CS	Roof element - Dachelement - Panneau de toit prémonté - Componente del tetto - Dakelement - Katusekilp 	4		
CS	Roof element - Dachelement - Panneau de toit prémonté - Componente del tetto - Dakelement - Katusekilp 	4		
	Floor fillet - Fussbodenleiste - Corniere de finition du plancher - Finitura per pavimento (battisco pa) - Vloerafwerkljst - Põrandaliist 		18x18	19.65
	Post - Pfosten - Poteau - Piede registrabile - Stijl - Post 	1	70x70	1883
TB-1	Fascia board - Traufbrett - Bandeau de toit - Finitura lati tetto - Gevellijst - Räästalaud 	2	18x90	3674

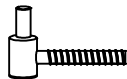
Pos	01.02.2018 Piece list - Stückliste - Liste des pièces - Elementi - Stuklijst - Tükitalabel Art. Nr. 4014600	18/19	Q	P (mm)	L (mm)
TB-2	Fascia board - Traufbrett - Bandeau de toit - Finitura lati tetto - Gevellijst - Räästalaud 		4	18x90	3840
DRV-1	Roof edge reinforcement - Dachrandverstärkung - Corniere de renfort de bord de toit - Rinforzo x tetto - Dakrand versterking - Räästatugevdus 		2	44x44	4000
	Terrace edge board - Terrassenbrett, eingang - Lamé de seuil d'entree de terrasse - Terrazzo uso abitacolo - Terrasvloer dorpel - Terrassi servaliist 		1	19x40	2510
KFS-1	Storm protection - Sturmleiste - Latte anti-tempete - Protezione anti vento - Stormverankering / beveiliging - Tormikinnitusliist 		6	22x45	2500
HS12	Screw for fascia boards - Schrauben für traufbretter - Vis pour fixation bandeau de toit - Viti x striscia del tetto - Schroef voor gevellijst - Kruvi räästalauale 		52	4x40	
HS12	Screws for terrace edge board - Schrauben für terrassenbrett - Vis de fixation de lame de seuil d'entree de terrasse - Vite per unire delle assi del terrazzo - Schroeven voor terrashout - Kruvi terrassi servaliistule 		7	4x40	
HS13	Screw for triangular fixing - Montagschraube für dreieckige - Vis d'assemblage pour triangle - Vite per fissaggio triangolare - Schroef voor driehoekig afdeklijst - Kruvi kolmnurga monteerimiseks seinale 		10	4x60	
HS13	Screw for post - Schrauben für pfosten - Vis de fixation des poteaux - Viti per inviare - Schroef voor stijlen - Kruvi postile 		2	4x60	
HS13	Screw for roof edge reinforcement - Schrauben für dachrandverstärkung - Vis pour fixation corniere renfort de bord de toit - Viti x rinforzo bordo tetto - Schroef voor dakrand versterking - Kruvi räästatugevdusele 		18	4x60	
HS18	Screw for foundation - Schrauben zur befestigung fundament - Vis de fixations des poutrelles de fondations - Viti x fondamenta - Schroef voor fundering - Kruvi alusraamile 		42	5x120	
HS18	Screw for fixing roof elements - Schraube für befestigung dachelementen - Vis de fixation des panneaux de toit - Vite per fissare gli elementi del tetto - Schroef voor bevestiging dakelement - Kruvi kilpide kinnitamiseks seinaga 		48	5x120	
HS18	Screw for roof beams - Schrauben für dachbalken - Vis pour fixation pannes de toit - Viti per perline del tetto - Schroef voor gordingen / dakbalken - Kruvi pärlinitele 		22	5x120	
HS18	Screw for wall details - Schraube für wand details - Vis pour mur details - Viti per elementi della porta - Schroef voor wand details - Kruvi seinadetailidele 		25	5x120	
HS18	Screw for gable - Schrauben für giebel - Vis pour fixation des pignons - Viti per timpano - Schroef voor gevelpunt - Kruvi viilude kinnitamiseks 		4	5x120	
HS16	Screw for 1. wall beam - Schraube für 1. bohlenreihe - Vis de fixations 1ere rangée de madriers avec poutrelles de fondations - Vite fissaggio alle fondamenta - Schroef voor 1 wandbalk - Kruvi poolaualae 		10	5x90	
HS16	Screw for roof lath - Schraube für dachlatte - Vis pour latte - Vite per listello del tetto - Schroef voor daklat - Kruvi roovile 		14	5x90	
HS16	Screw for foundation - Schrauben zur befestigung fundament - Vis de fixations des poutrelles de fondations - Viti x fondamenta - Schroef voor fundering - Kruvi alusraamile 		6	5x90	
HS20	Screw for post height adjustment - Schrauben für regulierungsschraube für pfosten - Vis de fixation de support réglable de poteau - Viti per fissare ed aggiustare l'altezza del palo verticale - Schroef voor hoogte instelling sfijlen - Kruvi vajumispoldile 		8	6x50	
HS21	Screw for fixing roof elements - Schraube für befestigung - dachelementen - Vis de fixation des panneaux de toit - Vite per fissare gli elementi del tetto - Schroef voor bevestiging dakelement - Kruvi kilpide montaažiks 		120	6x80	
HS24	Screw for wall details - Schraube für wand details - Vis pour mur details - Viti per elementi della porta - Schroef voor wand details - Kruvi seinadetailidele 		8	8x220	
NF2	Zn nail for floor fillet - Zn nägel für fussbodenleiste - Pointe pour corniere de finition du plancher - Chiodi x fissaggio pavimento - Spijker(nagel) voor vloer afdeklijst - Nael põrandaliistule 		40	1.4x40	
SH40	Hammer block - Schlagholz - Calle de frappe - Blocco di legno da usare come cuscinetto quando si usa il martello - Slagklos - Löögiklots 		1		
SFS	Nut for storm protection - Schraubenmutter für sturmleiste - Erou pour latte anti-tempete - Dado x asta protezione vento - Moer voor stormverankering - Mutter tormikinnitusliistule 		12	D6	

Pos	24.11.2017 Piece list - Stückliste - Liste des pièces - Elementi - Stuklijst - Tükitalabel 710x1224 AK.1.106.TSSP SGC	1/1	Q	P (mm)	L (mm)
	<p data-bbox="258 145 1292 174">Glass size - Glasgröße - Taille de la vitre - Misura del vetro - Glas afmeting - Klaasi mõõt: 566x1080 mm</p>   <p data-bbox="1369 342 1492 371">610x1124 mm</p>				
FS1	<p data-bbox="258 1948 1021 2004">Window handle fittings - Fenstergriff - Poignée de fenetre - Maniglia c/ferramenta - Raamhendel -/grendel -/klink - Aknalink</p>		2		
FSP	<p data-bbox="258 2027 1101 2105">Bolt for window handle fittings - Bolzen für fenstergriff beschlag - Vis pour fixation poignée de fenetre - Bullone x apertura manuale finestra - Schroef voor raamhendel - Akna käepideme polt</p>		4		
HS1	<p data-bbox="258 2116 1109 2195">Screw for georgian bars - Schraube für sprossen - Vis pour croisillons - Viti per unire la griglia georgiana della finestra - Schroeven voor raamverdeling - Krugi akna petfeliistule</p>		6	2.5x20	

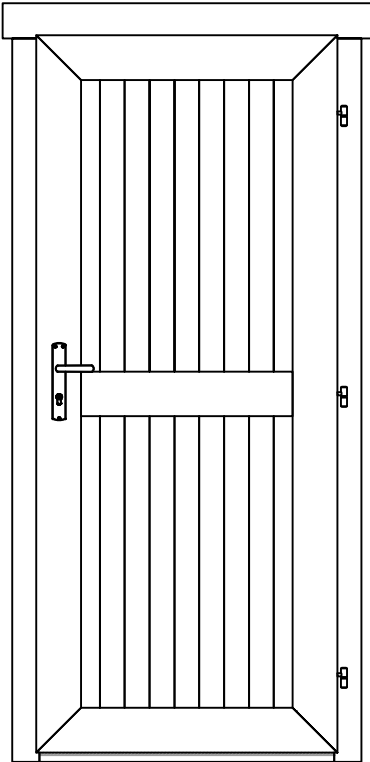
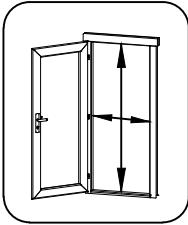
Pos	24.11.2017 Piece list - Stückliste - Liste des pièces - Elementi - Stuklijst - Tükítabel 710x1224 AK.1.106.TSSV SGC	1/1	Q	P (mm)	L (mm)
	<p data-bbox="258 152 1289 183">Glass size - Glasgröße - Taille de la vitre - Misura del vetro - Glas afmeting - Klaasi mõõt: 566x1080 mm</p>   <p data-bbox="1369 349 1490 376">610x1124 mm</p>				
FS1	<p data-bbox="258 1953 1021 2007">Window handle fittings - Fenstergriff - Poignée de fenetre - Maniglia c/ferramenta - Raamhendel -/grendel -/klink - Aknalink</p>		2		
FSP	<p data-bbox="258 2029 1104 2110">Bolt for window handle fittings - Bolzen für fenstergriff beschlag - Vis pour fixation poignée de fenetre - Bullone x apertura manuale finestra - Schroef voor raamhendel - Akna käepideme polt</p>		4		
HS1	<p data-bbox="258 2119 1104 2199">Screw for georgian bars - Schraube für sprossen - Vis pour croisillons - Viti per unire la griglia georgiana della finestra - Schroeven voor raamverdeling - Krugi akna petfeliistule</p>		6	2.5x20	

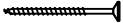
Pos	24.11.2017 Piece list - Stückliste - Liste des pièces - Elementi - Stuklijst - Tükitalabel 1494x1957 TUK.1.108.TSVP.MMb SGC	1/1	Q	P (mm)	L (mm)
	<p>Glass size - Glasgröße - Taille de la vitre - Misura del vetro - Glas afmeting - Klaasi mõõt: 514x1593 mm</p>   <p>1394x1873 mm</p>				
HS1	Screw for georgian bars - Schraube für sprossen - Vis pour croisillons - Viti per unire la griglia georgiana della finestra - Schroeven voor raamverdeling - Kruvi ukse peffeliistule		16	2.5x20	
HS4	Screw for door fillet - Schraube zur befestigung türleiste - Vis pour fixation baguette d'arret de porte - Viti per massellino della porta - Schroef voor deurlijst - Kruvi ukse kokkuvaltšiliistule		5	3x30	
HS16	Screw for door jamb - Schraube für türrahmen - Vis de fixation partie haute avec montants du cadre de porte - Viti x fissaggio montanti porte - Schroef voor deurkozijn - Kruvi ukse lengile		4	5x90	
HS25	Screw for doorstep - Schrauben für swelle - Vis pour fixation barre de seuil - Vite per soglia della porta - Schroef voor deurdorpel - Kruvi lävepakule		3	4.5x65	
TL4	Door handle fittings - Türgriff - Poignee de porte - Maniglie - Deurhendel / klink - Ukse käepide		1		
TL5	Set of door lock covers - Schlossblenden - Set de garnitures de porte - Copertura serrature - Slot sluitplaat set - Ukse lukuplaat		1		
	Cylinder lock - Zylinderschloss - Barillet de porte - Serratura - Cylinder slot - Ukse lukusüdamik		1	30x35	
	Male bolt hinge for door - Türband - Partie male de paumelle de porte - Cerniera anube x porta - Scharnier bout - Ukse polthing isane		6		
	Striker for barrel bolt - Hülse für grendelriegel - Gache au sol du targette - Boccola per fermo della porta - Huls voor vergrendelingsschuif - Vasturaud ukse servariivile		2		

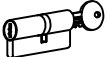
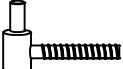
Pos	13.01.2017	Piece list - Stückliste - Liste des pièces - Elementi - Stuklijst - Tükitalabel 835x1900 UL.2.100.IVP.MMd TC	1/1	Q	P (mm)	L (mm)
		  <p>735x1818 mm</p>				
HS25	Screw for doorstep - Schrauben für swelle - Vis pour fixation barre de seuil - Vite per soglia della porta - Schroef voor deurdorpel - Kruvi lävepakule		2	4.5x65		
HS16	Screw for door jamb - Schraube für türrahmen - Vis de fixation partie haute avec montants du cadre de porte - Viti x fissaggio montanti porte - Schroef voor deurkozijn - Kruvi ukse lengile		4	5x90		
TL4	Door handle fittings - Türgriff - Poignée de porte - Maniglie - Deurhendel / klink - Ukse käepide		1			
TL5	Set of door lock covers - Schlossblenden - Set de garnitures de porte - Copertura serrature - Slot sluitplaat set - Ukse lukuplaat		1			
	Cylinder lock - Zylinderschloss - Barillet de porte - Serratura - Cylinder slot - Ukse lukusüdamik		1	30x35		
	Male bolt hinge for door - Türband - Partie male de paumelle de porte - Cerniera anube x porta - Scharnier bout - Ukse polthing isane		3			