

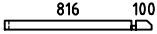

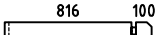

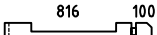





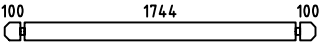
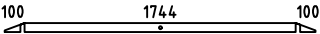
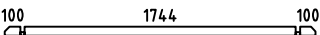
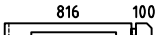
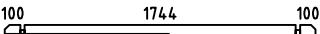
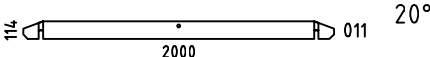
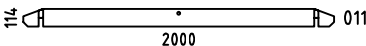
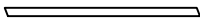
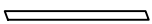

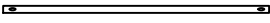

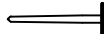



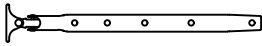

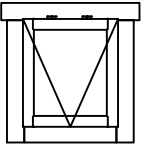
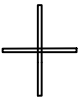
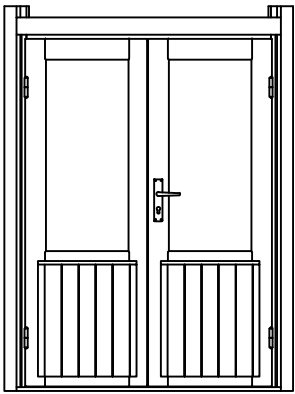
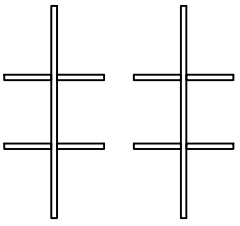
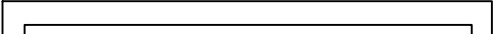

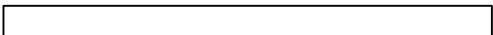

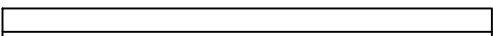

Sunny28A

Pos	Specification-Spezifikation-Specificatie Sunny28A	St.	Profile (mm)	Length (mm)
001		1	28x57	944
002		22	28x114	944
003		1	28x114	944
004		10	28x114	170
005		10	28x114	228
006		37	28x114	2000
007		2	28x57	2000
008		1	28x57	2000
009		1	28x114	944
010		1	28x114	2000
WA-1		1		
WB-1		1		
SR1	RAFTER-DACHSPARREN-DAKSPAR 	4	44x55	1256
SR2	RAFTER-DACHSPARREN-DAKSPAR 	4	44x55	926
	Eave Board-Traubret-Dakranden board 	4	18x70	2250
	Storm Brace-Sturmleiste 	3	18x40	2000
PE1	Ceiling Element-Deckenelement-Plafond Element 3 	1	830x1173	
	Double Door Set-Doppeltür Satz-Dubbele Deur Set  3x25 x2 4x60 x4	1		
	Nail-Nagel-Spijker 1.2x20 	25	1.2x20	
N1	Ridge piece-Firstelement-Nokstuk 	1		
DE1	Roof Panel-Dach Elemente-Dakpanelen 	4+4	1175+1098	
	Screw-Schraube-Schroef 4x60 	80		
	Ventilation Panel-Lüftungsgitter Set 	1		
WS1	Window Stay-Fensterfeststelle 	2		
	Wood Bolt set for Storm Brace-Holzschraubensatz für Sturmleisten 6x45 	6		
Kood	GartenHaus GmbH	Materjal	File Sunny28A.dwg	Leht 1/2

Pos	Specification-Spezifikation-Specificatie Sunny28A			St.	Profile (mm)	Length (mm)
HS1	Wood Bolt set-Holzschraubesatz-Hout Bout 8x80			4		
W4N 5 4x60.5	WINDOW 540x605  Window Glazing Bar Fenstersprossen Raamroeden 			2		
DD6P 127.2 x189.1	DOOR 1272x1891  Door Glazing Bar Türsprossen Deurroeden 			1		
CORNER DOOR SET						
1	Top Jamb			1	58x42	1272
2	Threshold			1	58x42	1272
3-4	Vertical Jamb			2	58x42	1891
5-6	Post Set			1+1	42x61	2020
7-8	Cover Slat			2	40x18	1860
9-10	Casting			2	18x95	1500
	Screw-Schraube-Schroef 4x60			16		
	Screw-Schraube-Schroef 5x90			16		
Kood	GartenHaus GmbH	Materjal	File Sunny28A.dwg	Leht	2/2	

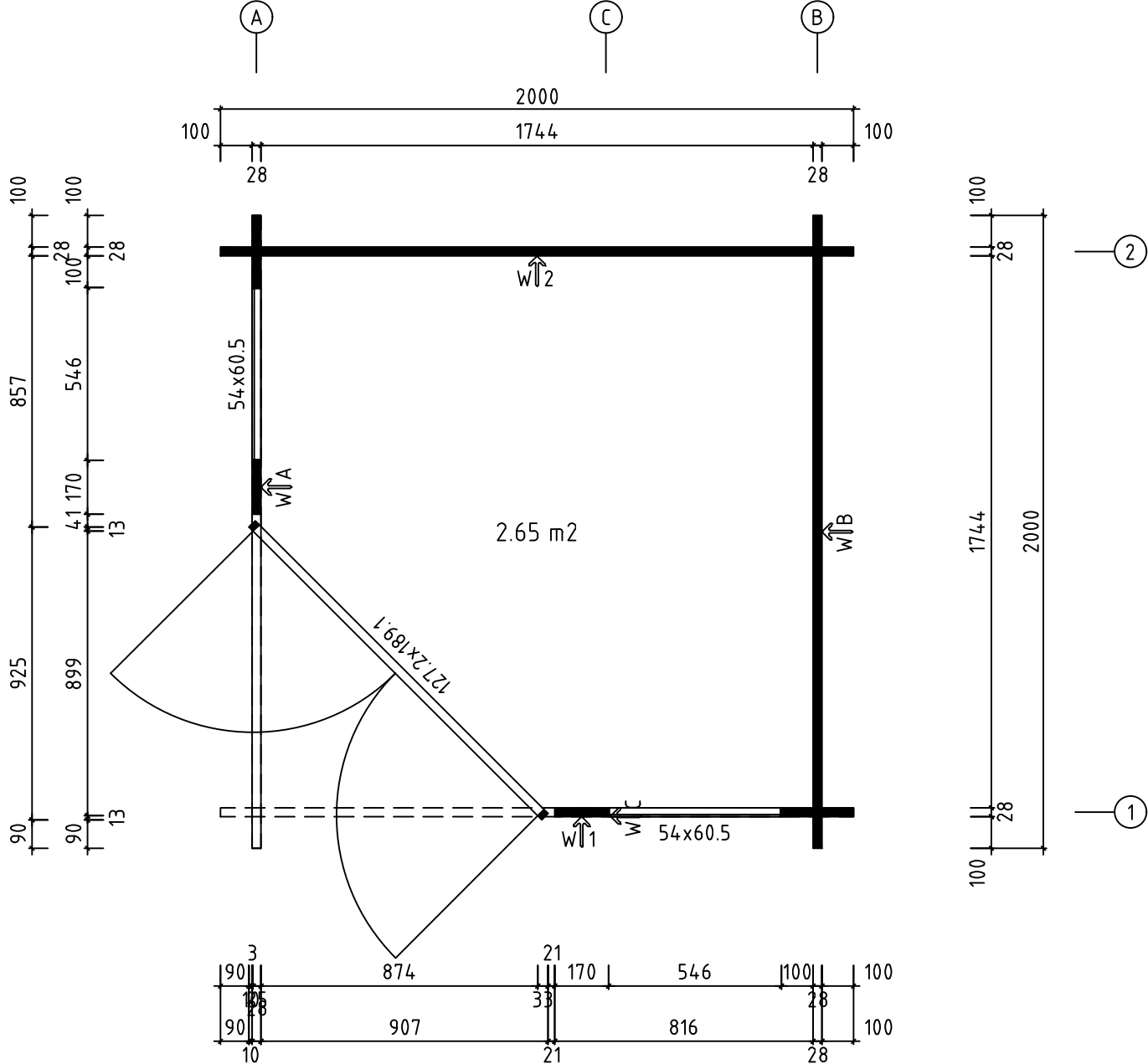
H = 1.700 m
 TOTAL: 2.65 m²



Model	Sunny28A		Drawing	PLAN		Page	
 www.gartenhaus-gmbh.de www.gartenhaus.at www.gartenhaus.ch +49 (0) 40 537 9978-50	Drawn by	J.Soo	Material	28x114		Scale	1:20
	Date	30.11.2018		File	Sunny28A.dwg		

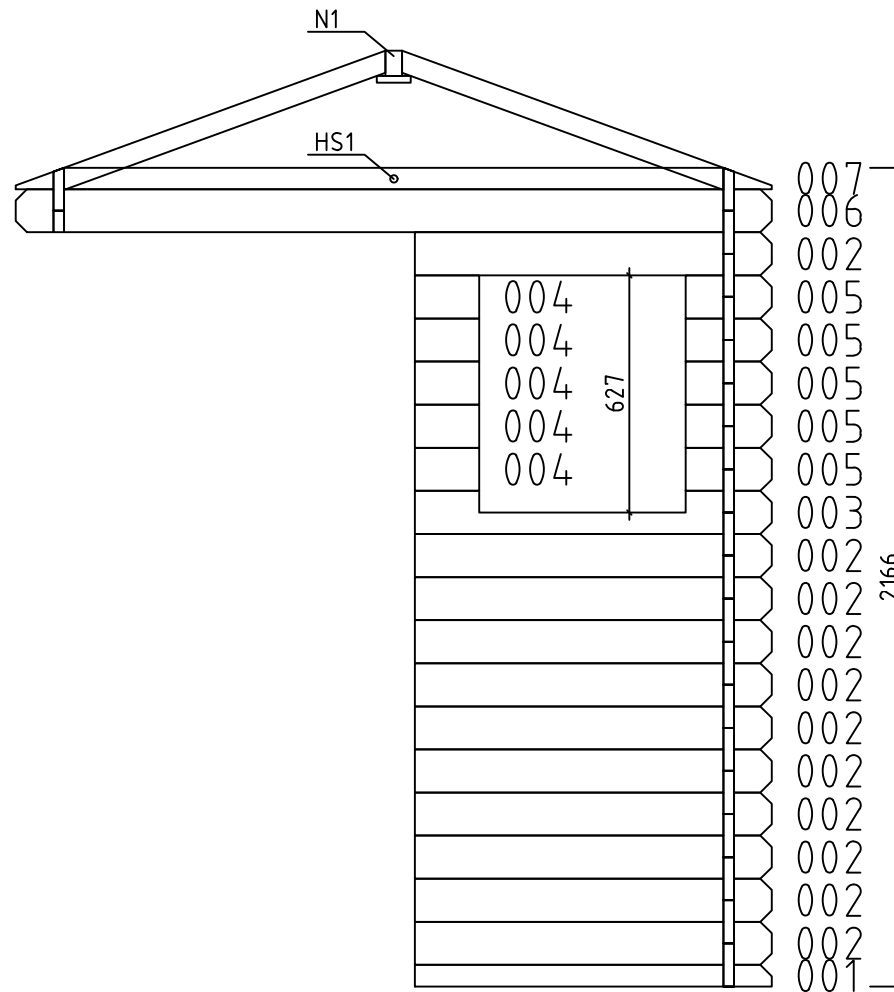

Wall-Wand 1 ↗

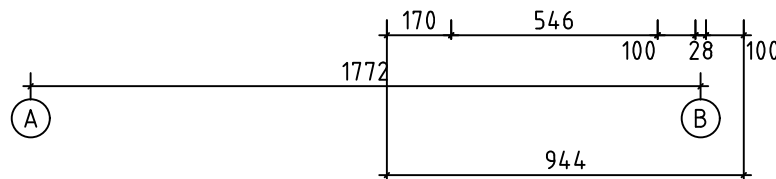

Model	Sunny28A	Drawing	WALL-WAND 1	Page	6	
 www.gartenhaus-gmbh.de www.gartenhaus.at www.gartenhaus.ch +49 (0) 40 537 9978-50	Drawn by	J.Soo	Material	2.8x11.4	Scale	1:20
	Date	30.11.2018	File	Sunny28A.dwg		

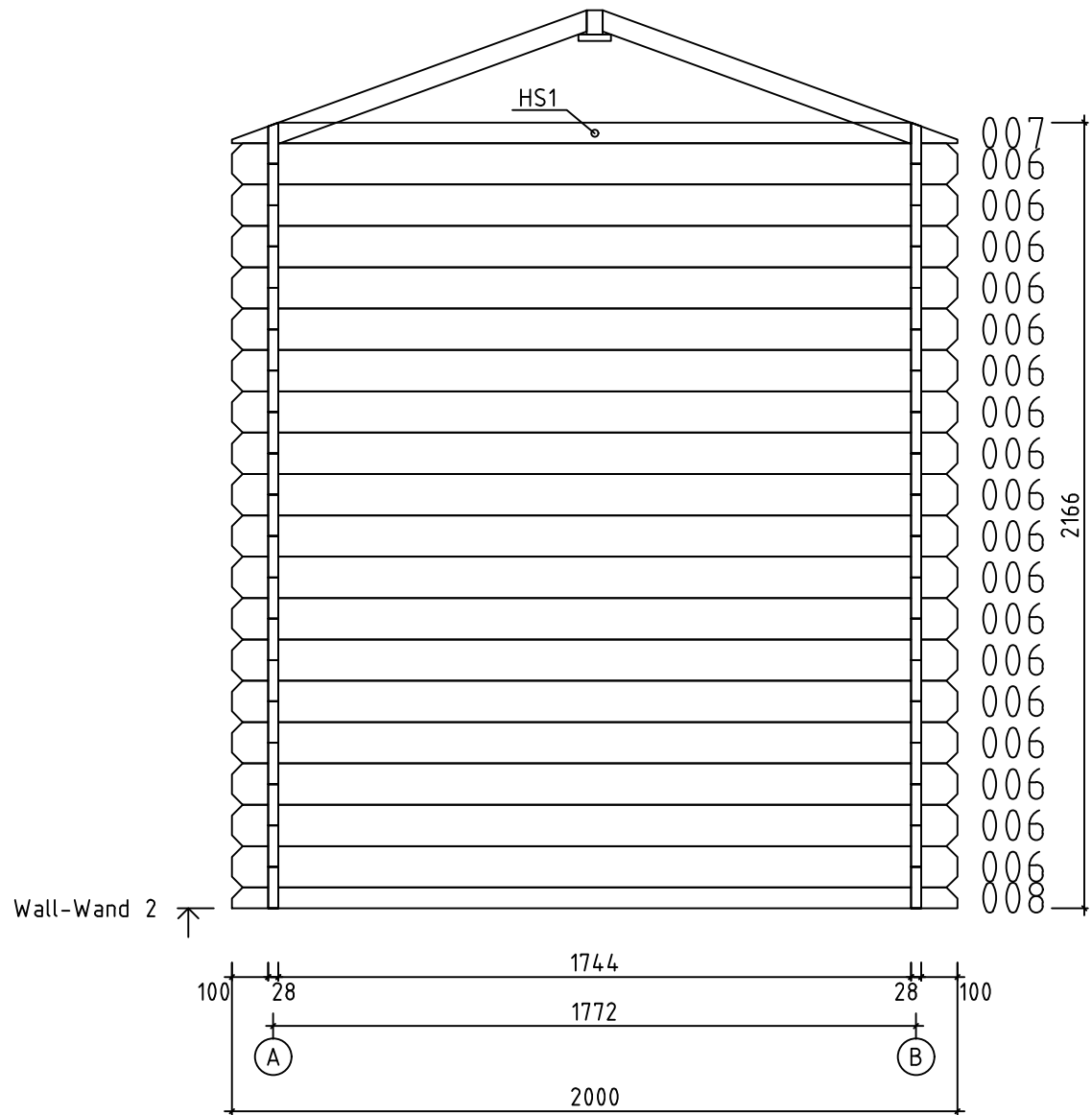

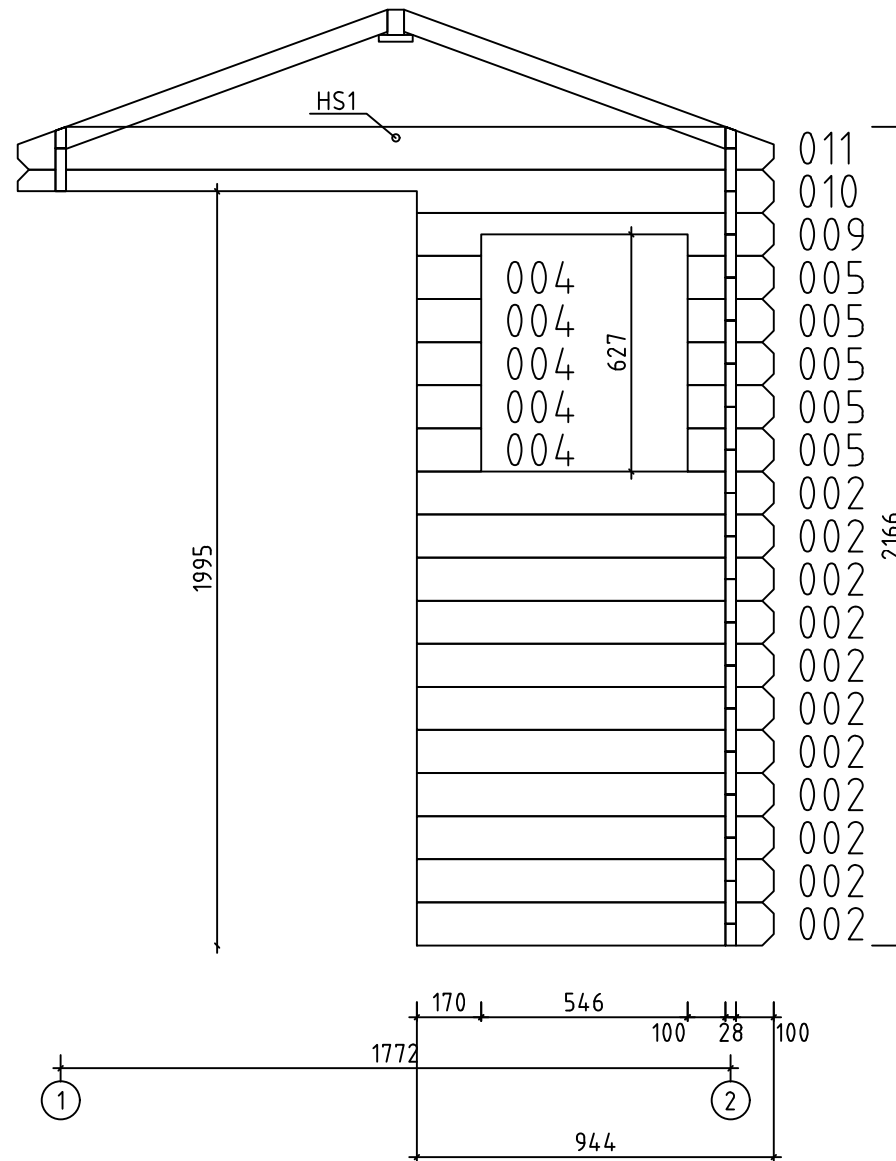

Model	Sunny28A	Drawing	WALL-WAND 2	Page	7	
 www.gartenhaus-gmbh.de www.gartenhaus.at www.gartenhaus.ch +49 (0) 40 537 9978-50	Drawn by	J.Soo	Material	2.8x11.4	Scale	1:20
	Date	30.11.2018	File	Sunny28A.dwg		



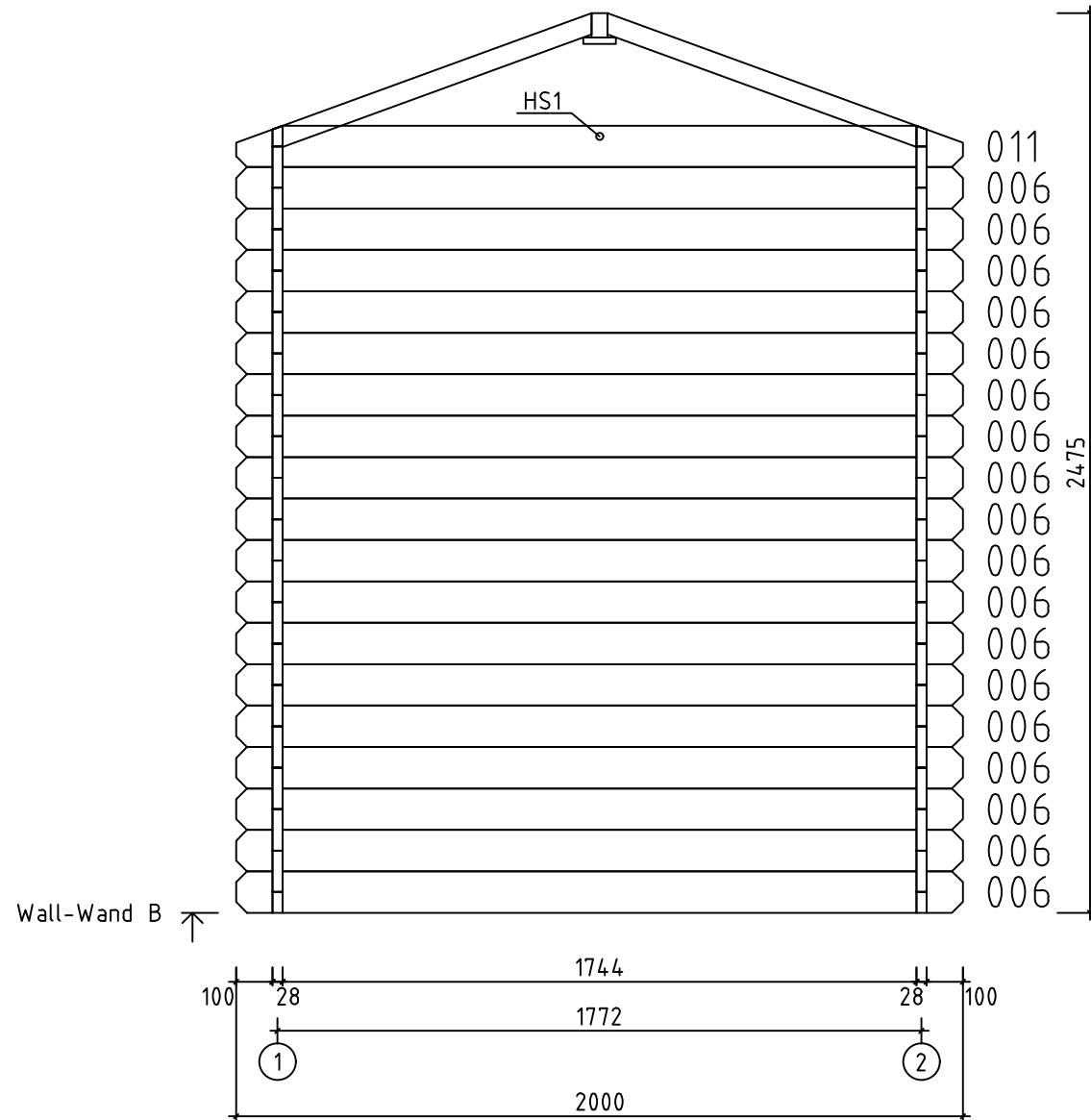

Wall-Wand A ↗

Model	Sunny28A	Drawing	WALL-WAND A	Page	3	
 www.gartenhaus-gmbh.de www.gartenhaus.at www.gartenhaus.ch +49 (0) 40 537 9978-50	Drawn by	J.Soo	Material	2.8x11.4	Scale	1:20
	Date	30.11.2018	File	Sunny28A.dwg		

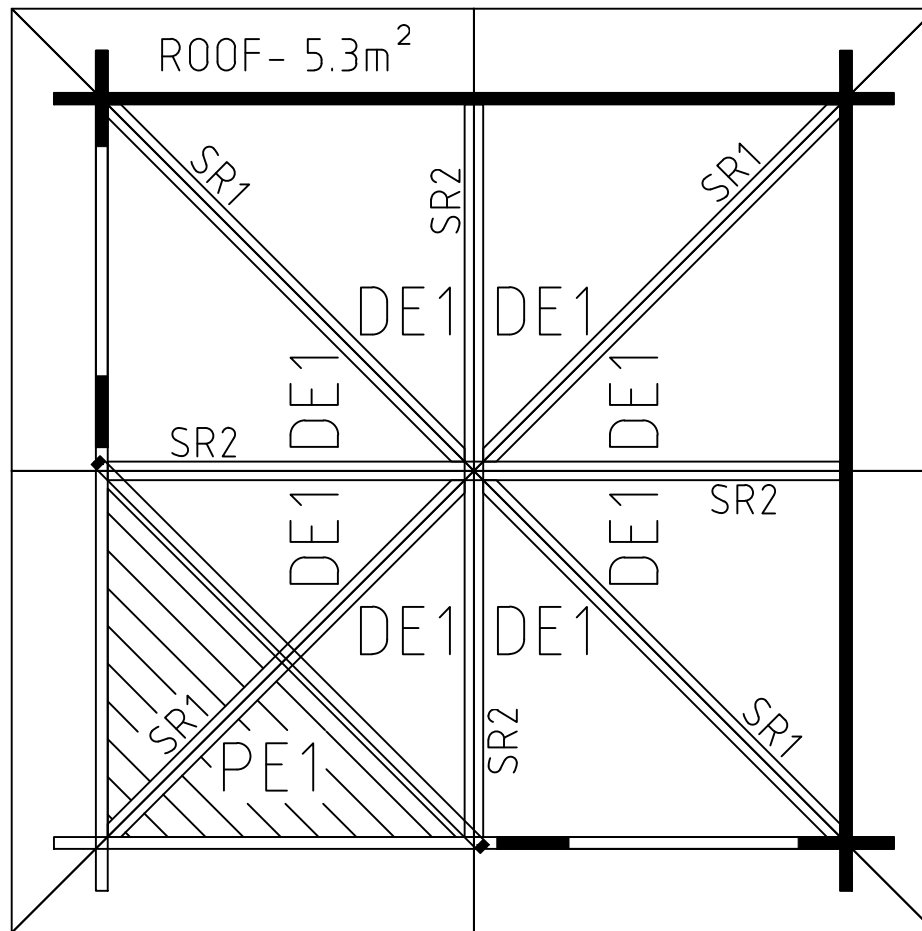

Model	Sunny28A	Drawing	WALL-WAND B	Page	4	
 www.gartenhaus-gmbh.de www.gartenhaus.at www.gartenhaus.ch +49 (0) 40 537 9978-50	Drawn by	J.Soo	Material	2.8x11.4	Scale	1:20
	Date	30.11.2018	File	Sunny28A.dwg		



Model	Sunny28A	Drawing	ROOF	Page
 www.gartenhaus-gmbh.de www.gartenhaus.at www.gartenhaus.ch +49 (0) 40 537 9978-50	Drawn by	J.Soo	Material	28x114
	Date	30.11.2018	File	Sunny28A.dwg

The guide is illustrative. This guide is not project specification.
Der Leitfaden ist illustrativ. Dieser Leitfaden ist keine Projektspezifikation.
De gids is illustratief. Deze gids is geen projectspecificatie.

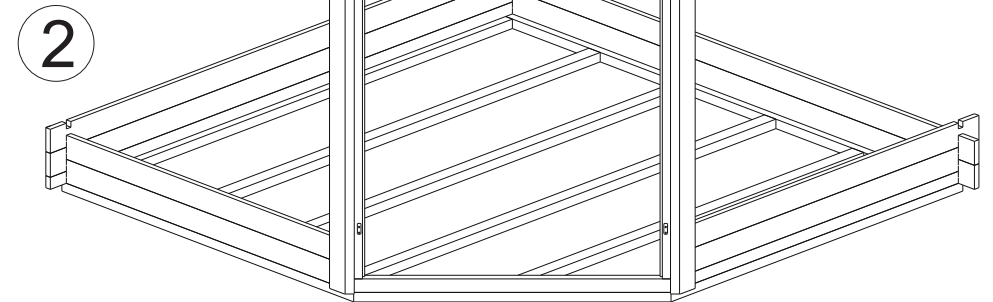
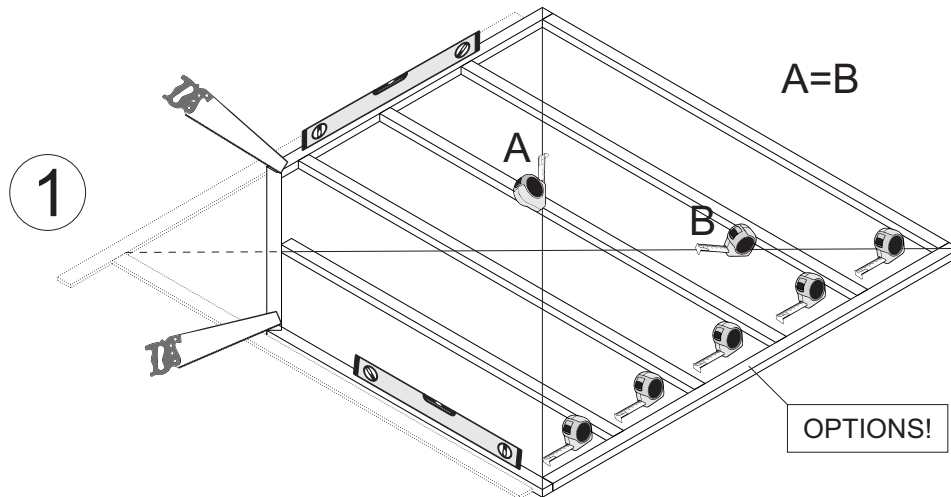
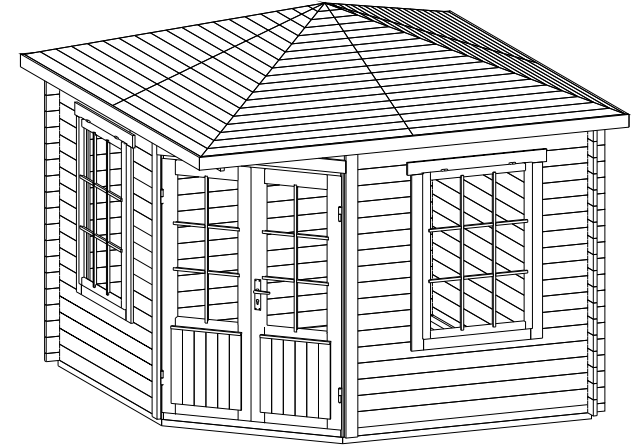
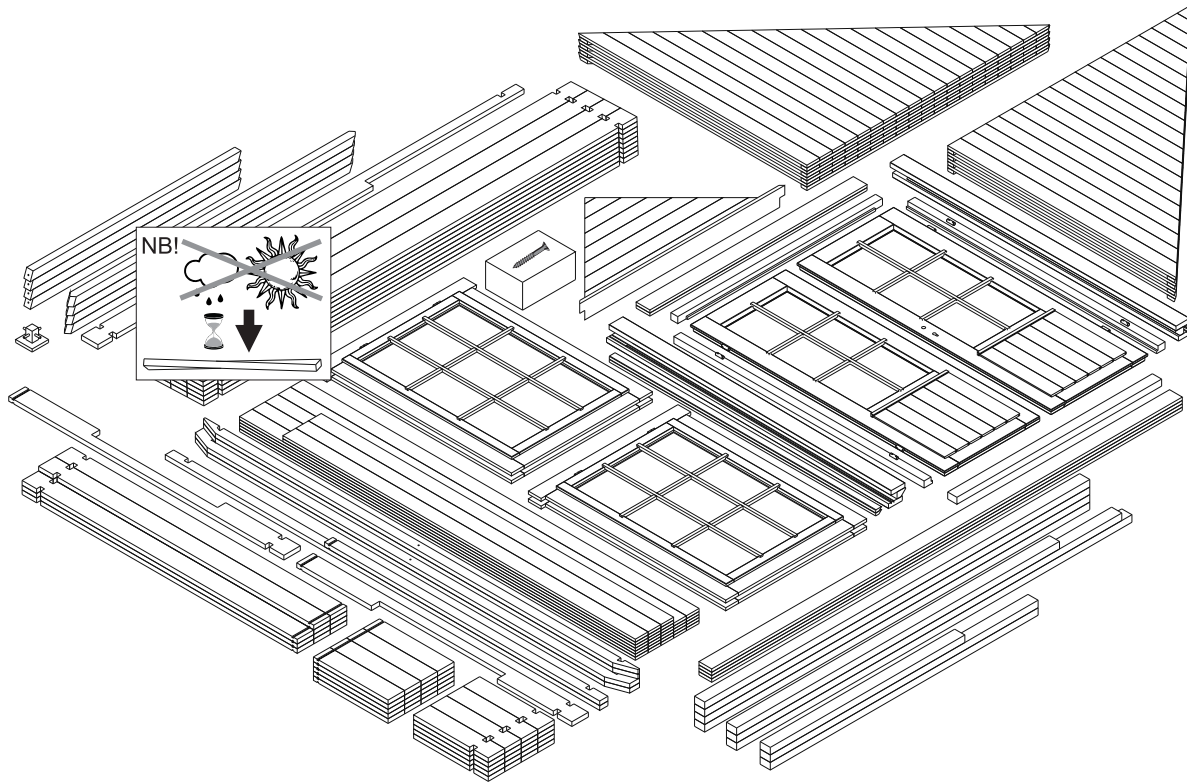

2

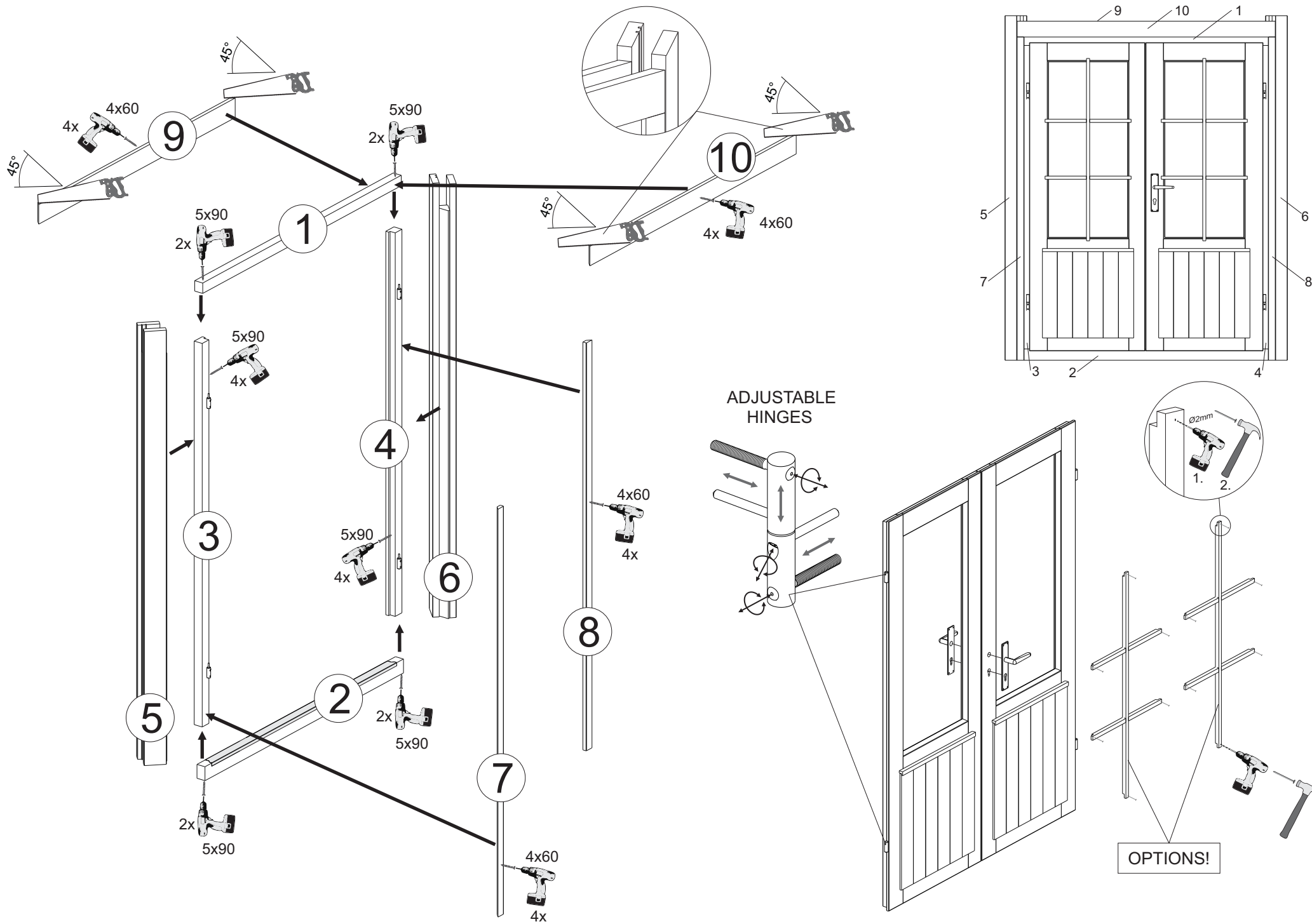

3

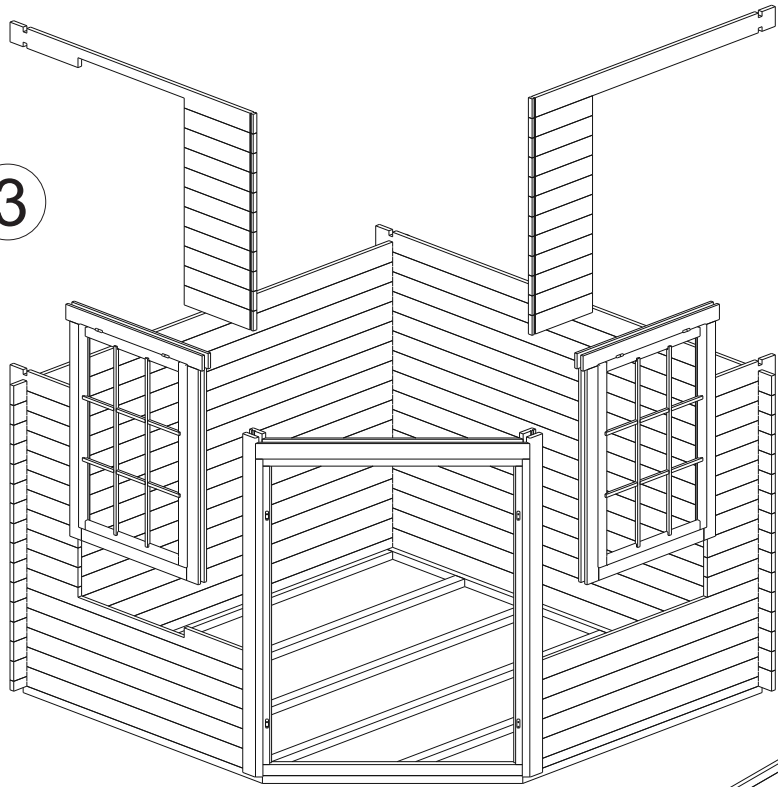

5

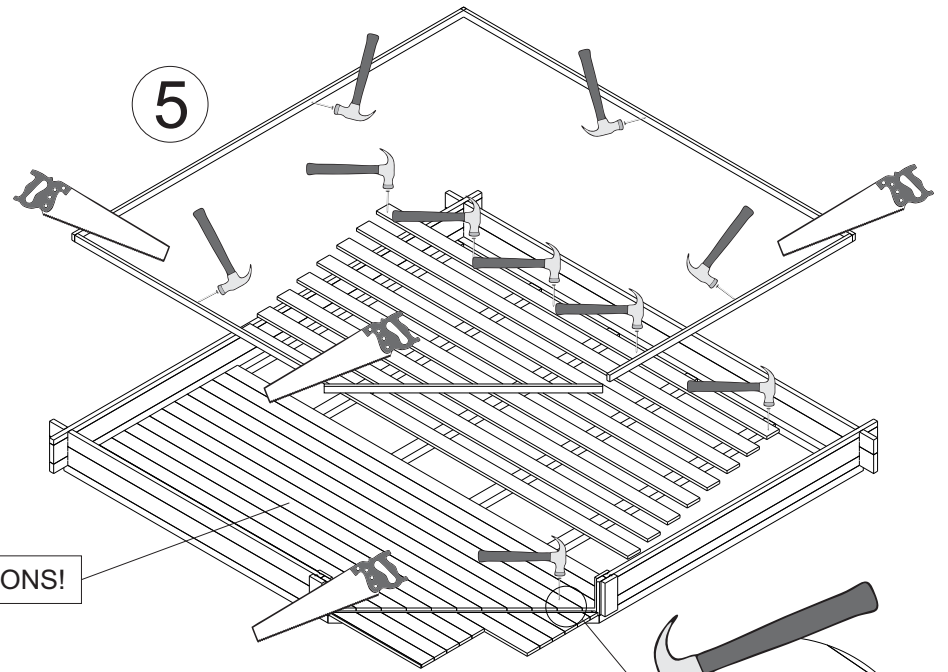

OPTIONS!

4

