

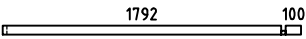

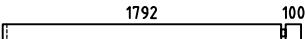







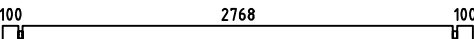
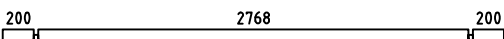
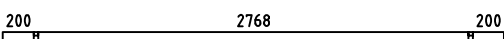



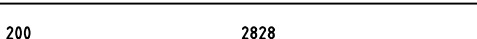
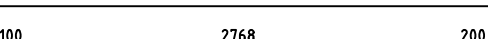
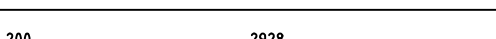
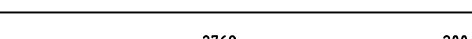
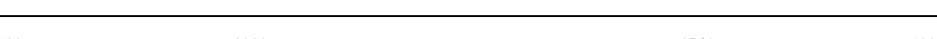
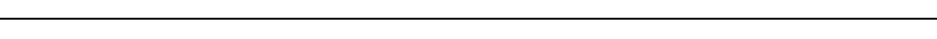

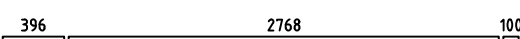
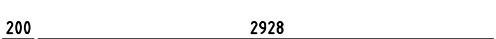
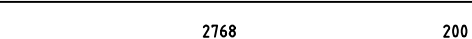
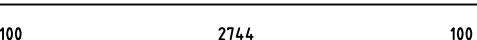
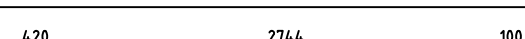
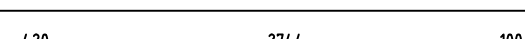
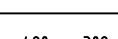

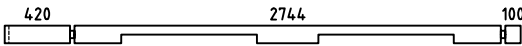
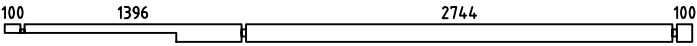
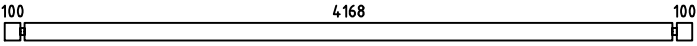
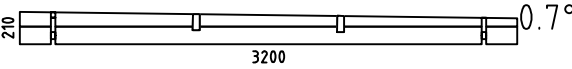
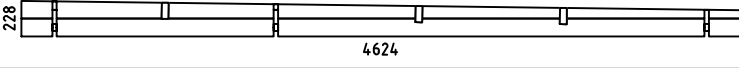
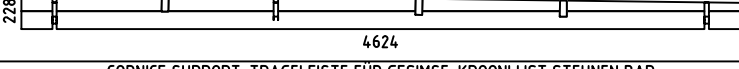

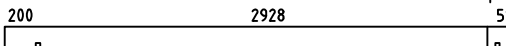
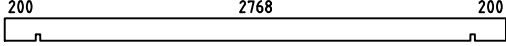
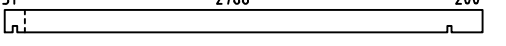
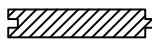

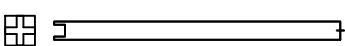



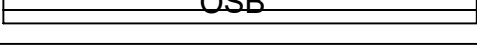
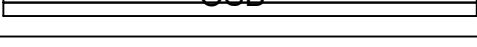
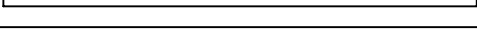
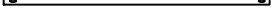

Pepe28

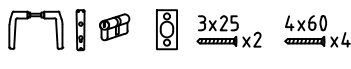
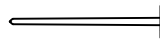
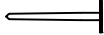
Pos	Specification-Spezifikation-Specificatie Pepe28	St.	Profile (mm)	Length (mm)
001		1	28x57	1920
002		6	28x114	1920
003		11	28x114	525
004		22	28x114	525
005		1	28x114	3024
006		1	28x114	3224
007		1	28x54	3224
008		1	28x57	228
009		34	28x114	228
010		1	28x114	3184
011		1	28x114	3056
012		1	28x114	3124
013		1	28x36	3170
014		1	28x36	3010
015		1	28x57	5980
016		7	28x114	5980
017		21	28x114	395
018		11	28x114	3320
019		1	28x114	3170
020		1	28x114	3010
021		1	28x114	3000
024		5	28x114	3320
025		1	28x114	3320
026		10	28x114	750
027		10	28x114	430
Kood	GartenHaus GmbH	Materjal	File Pepe28.dwg	Leht 1/3

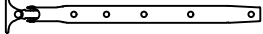
Pos	Specification-Spezifikation-Specificatie Pepe28	St.	Profile (mm)	Length (mm)
028		1	28x114	3320
029		1	28x114	4424
032		18	28x114	4424
WA-1		1		
WB-1		1		
WC-1		1		
CS1	CORNICE SUPPORT-TRAGELEISTE FÜR GESIMSE-KROONLIJST STEUNEN BAR 	2	44x70	200
PR1	Purlin-Dakbalk-Dachpfette 	2	44x144	3235
PR3	Purlin-Dakbalk-Dachpfette 	1	44x144	3224
PR2	Purlin-Dakbalk-Dachpfette 	2	44x144	3075
DP1	Roof board-Dachbrett-Dakplank 	37	88x18	4624
DP2	Roof board-Dachbrett-Dakplank 	34	88x18	3200
	+POST 85x85 	1		2040
PE1	Ceiling Element-Deckenelement-Plafond Element 1 	1	886x1253	
L1	Cornice-Gesimse-Kroonlijst 	1	20x250	1412
L2	Cornice-Gesimse-Kroonlijst 	1	20x250	2976
L3	Cornice-Gesimse-Kroonlijst 	1	20x250	3030
L4	Cornice-Gesimse-Kroonlijst 	1	20x250	3190
L5	Cornice-Gesimse-Kroonlijst 	1	20x250	3216
L6	Cornice-Gesimse-Kroonlijst 	1	20x250	3264
L7	Cornice-Gesimse-Kroonlijst 	1	20x250	4640
	Storm Brace-Sturmleiste 	5	18x40	2000
	Adjustable foot-Stellfuß+Schrauben 4x50 4stück für Post 	1		
	Double Door Set-Doppeltür Satz-Dubbele Deur Set 	1		
	Nail-Nagel-Spijker 	395		

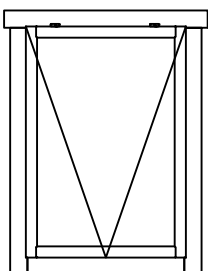
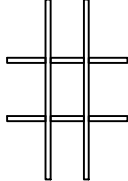
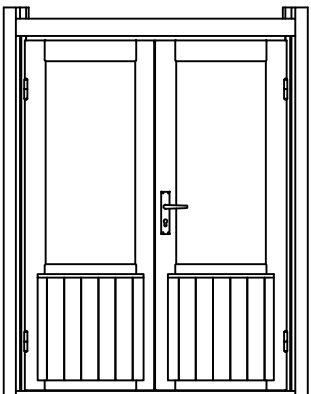
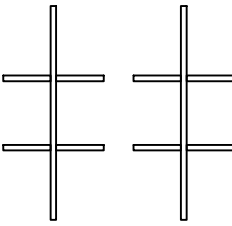
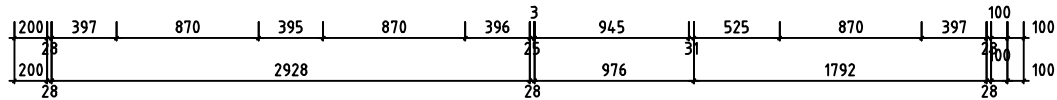
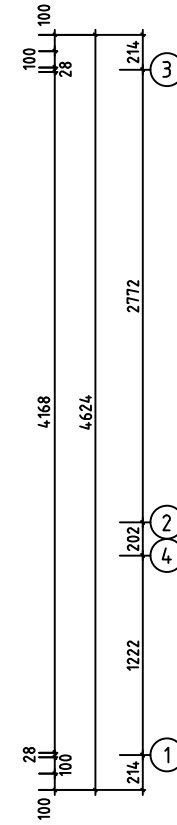
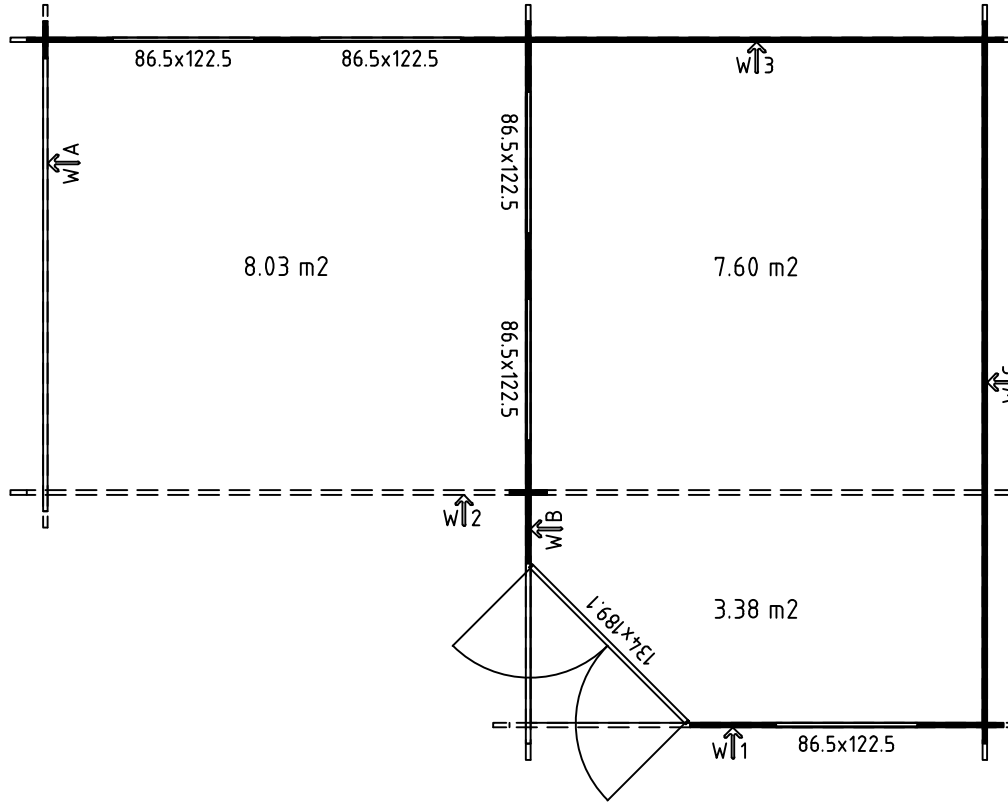
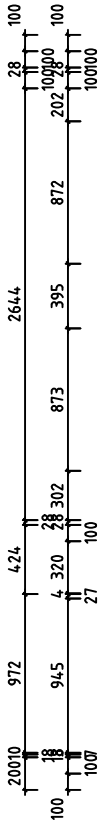
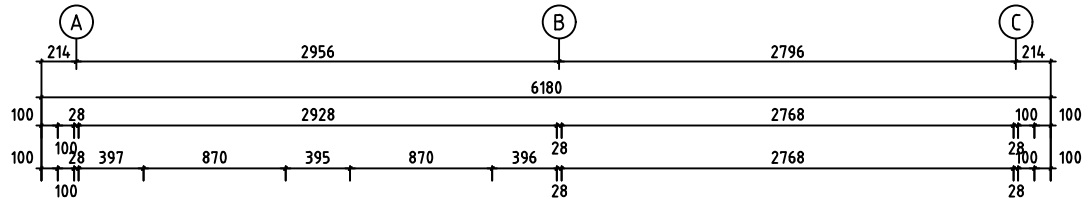
Pos	Specification-Spezifikation-Specificatie Pepe28	St.	Profile (mm)	Length (mm)
	Nail-Nagel-Spijker 1.2x20 	55		
	Screw-Schraube-Schroef 5x90 	4		
	Ventilation Panel-Lüftungsgitter Set 	1		
	Window Stay-Fensterfeststelle 	5		
	Wood Bolt set for Storm Brace-Holzschraubensatz für Sturmleisten 6x45 	10		
W9N 86.5 X122.5	<p>WINDOW 865x1225</p>  <p>Window Glazing Bar Fenstersprossen Raamroeden</p> 	5		
DD6P 134 X189.1	<p>DOOR 1340x1891</p>  <p>Door Glazing Bar Türsprossen Deurroeden</p> 	1		
Kood	GartenHaus GmbH	Materjal	File	Pepe28.dwg
			Leht	3/3



Model Pepe28  www.gartenhaus-gmbh.de www.gartenhaus.at www.gartenhaus.ch +49 (0) 40 537 9978-50	Drawing PLAN	Page 	
	Drawn by R.Tamm	Material 28x114	Scale 1:40
	Date 21.08.2018	File Pepe28.dwg	

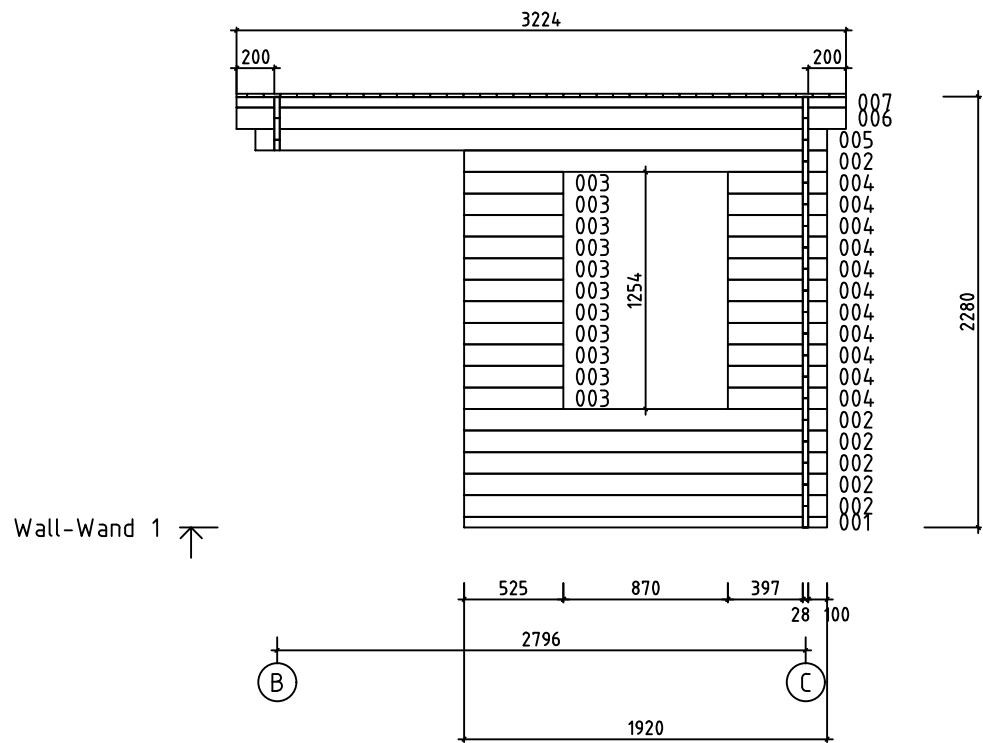

Model	Pepe28	Drawing	WALL-WAND 1	Page	5	
 www.gartenhaus-gmbh.de www.gartenhaus.at www.gartenhaus.ch +49 (0) 40 537 9978-50	Drawn by	R.Tamm	Material	2.8x11.4	Scale	1:40
	Date	21.08.2018	File	Pepe28.dwg		

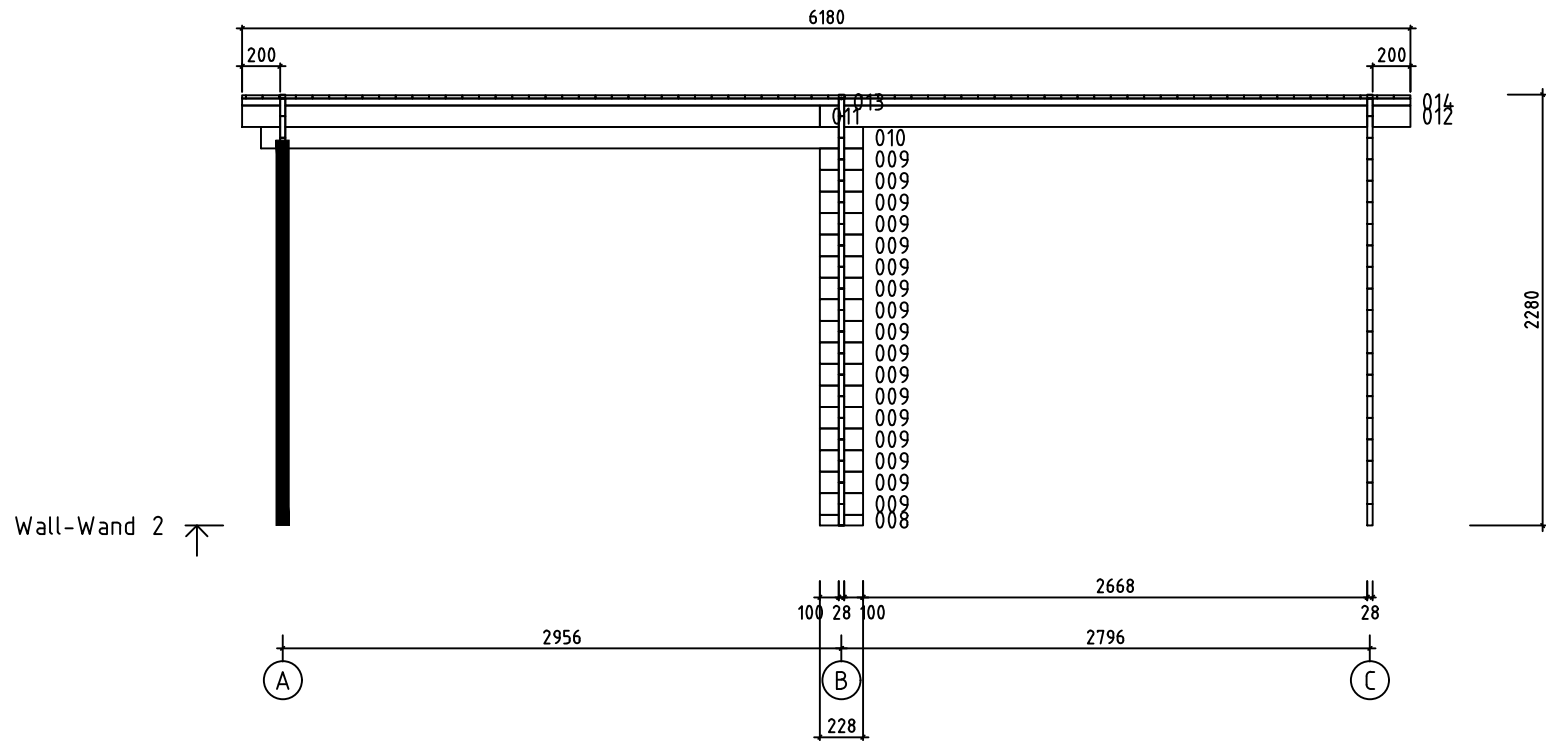

Model	Pepe28	Drawing	WALL-WAND 2	Page	6	
 www.gartenhaus-gmbh.de www.gartenhaus.at www.gartenhaus.ch +49 (0) 40 537 9978-50	Drawn by	R.Tamm	Material	2.8x11.4	Scale	1:40
	Date	21.08.2018	File	Pepe28.dwg		

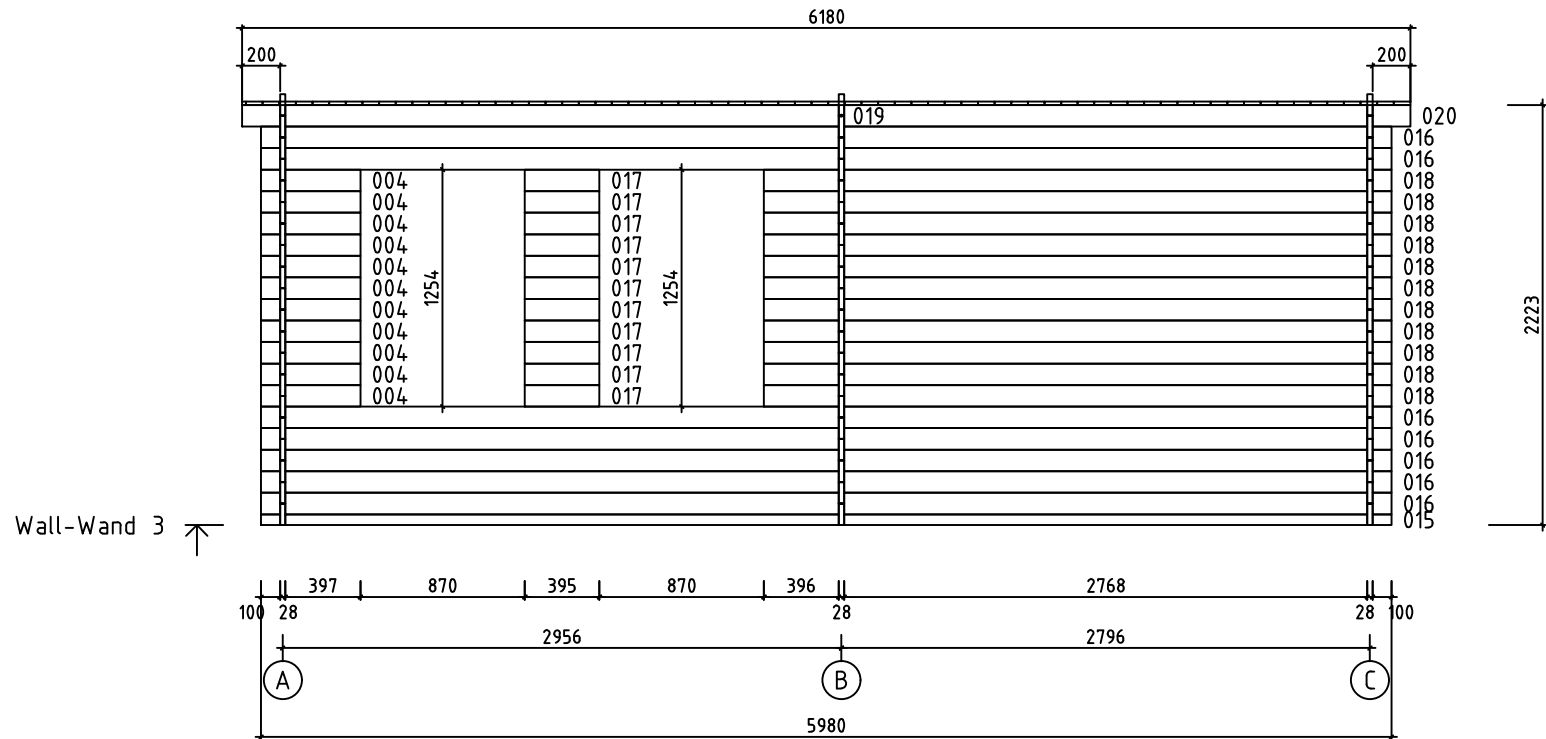

Model	Pepe28	Drawing	WALL-WAND 3	Page	7	
 www.gartenhaus-gmbh.de www.gartenhaus.at www.gartenhaus.ch +49 (0) 40 537 9978-50	Drawn by	R.Tamm	Material	2.8x11.4	Scale	1:40
	Date	21.08.2018	File	Pepe28.dwg		

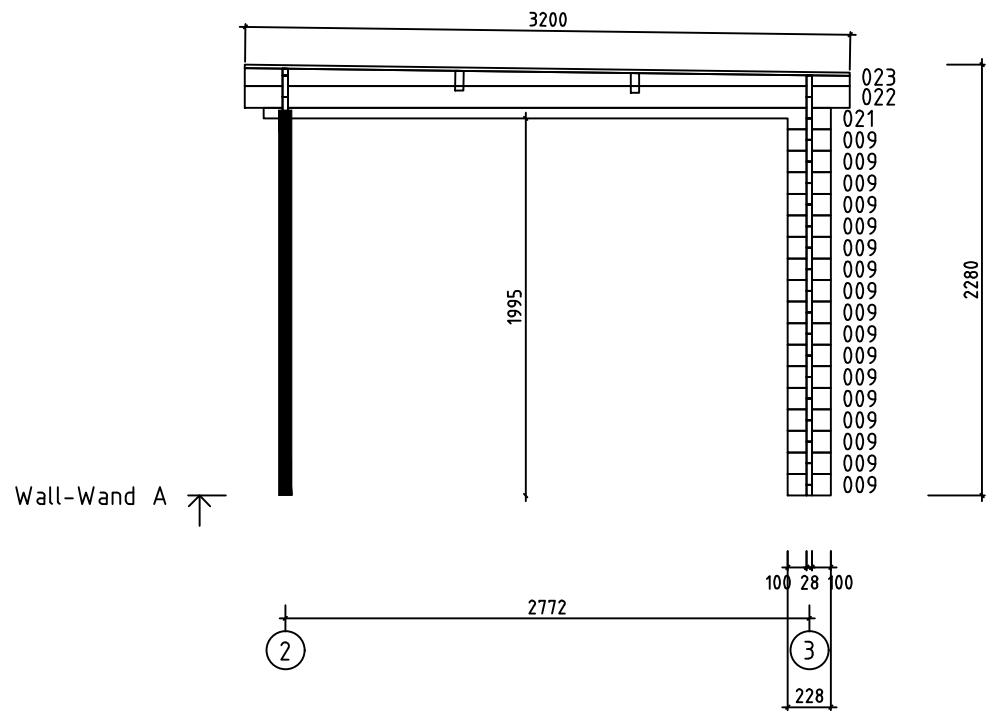

Model	Pepe28	Drawing	WALL-WAND A	Page	2	
 www.gartenhaus-gmbh.de www.gartenhaus.at www.gartenhaus.ch +49 (0) 40 537 9978-50	Drawn by	R.Tamm	Material	2.8x11.4	Scale	1:40
	Date	21.08.2018	File	Pepe28.dwg		

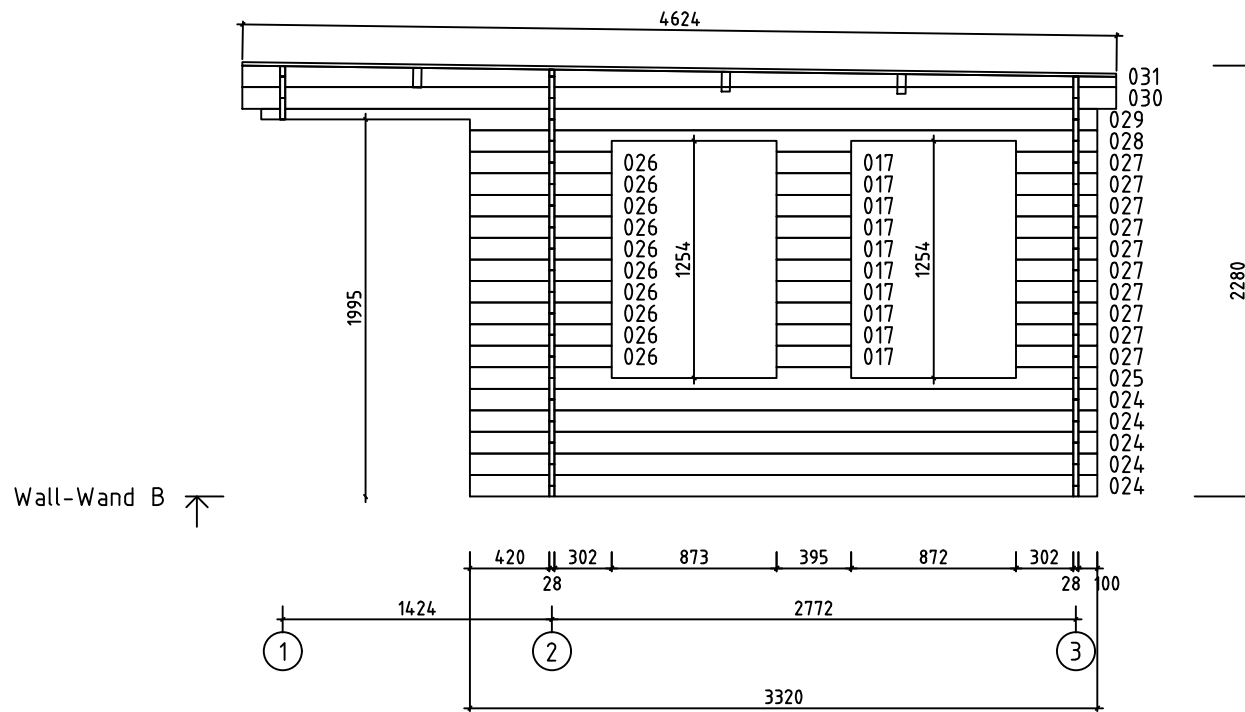

Model	Pepe28	Drawing	WALL-WAND B	Page	3	
 www.gartenhaus-gmbh.de www.gartenhaus.at www.gartenhaus.ch +49 (0) 40 537 9978-50	Drawn by	R. Tamm	Material	2.8x11.4	Scale	1:40
	Date	21.08.2018	File	Pepe28.dwg		

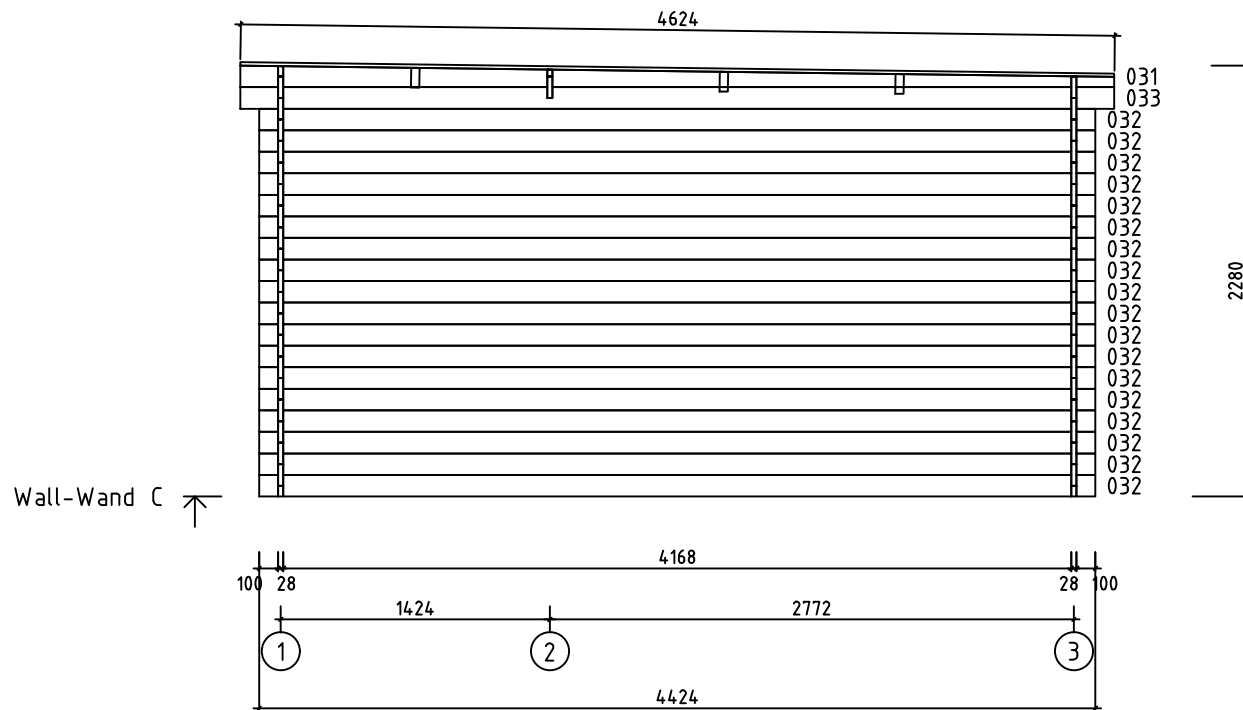

Model	Pepe28	Drawing	WALL-WAND C	Page	4	
 www.gartenhaus-gmbh.de www.gartenhaus.at www.gartenhaus.ch +49 (0) 40 537 9978-50	Drawn by	R.Tamm	Material	2.8x11.4	Scale	1:40
	Date	21.08.2018	File	Pepe28.dwg		

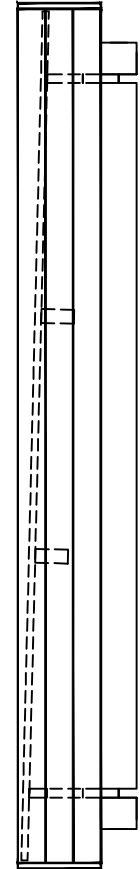
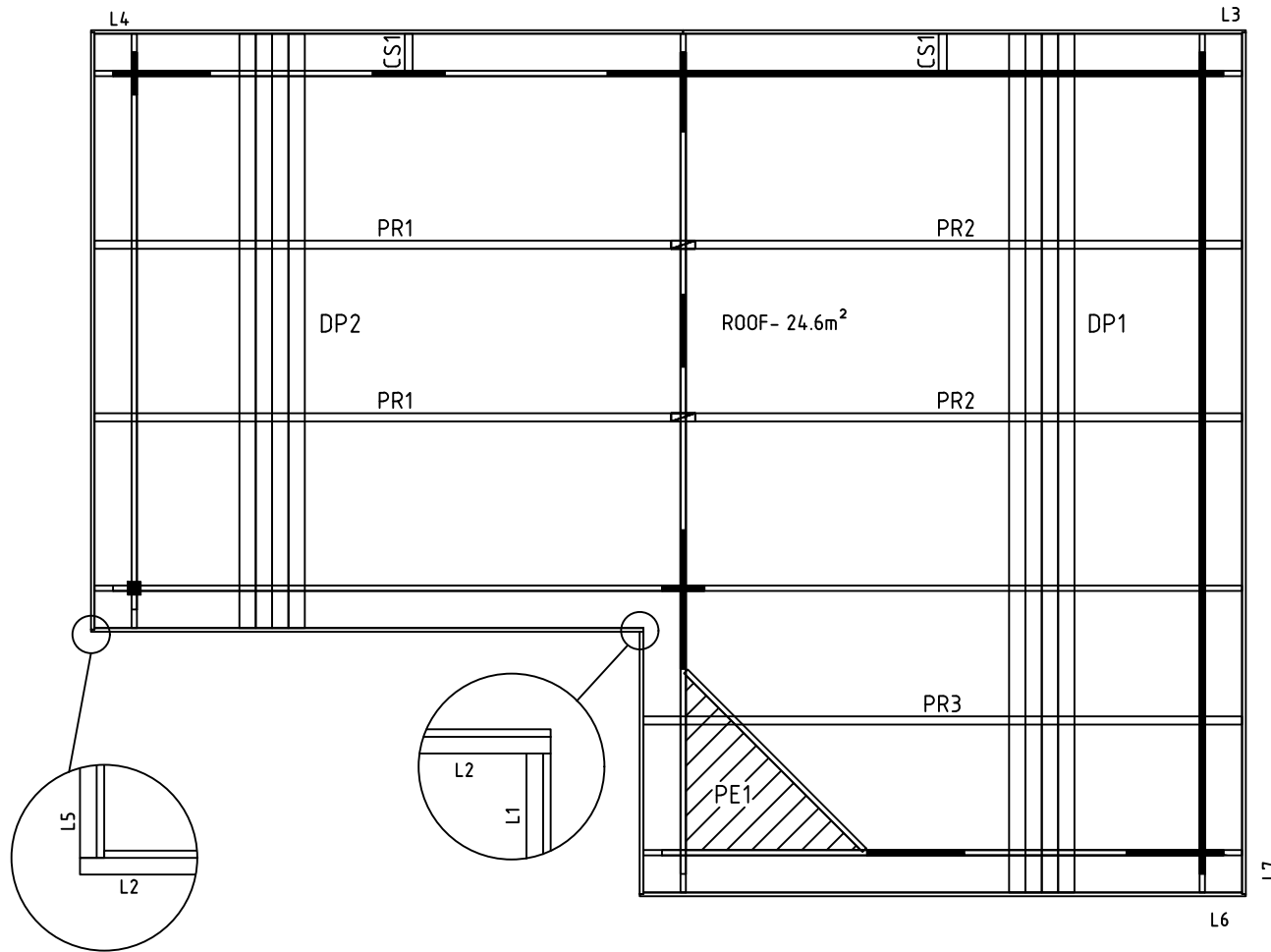

Model	Pepe28	Drawing	ROOF	Page
 www.gartenhaus-gmbh.de www.gartenhaus.at www.gartenhaus.ch +49 (0) 40 537 9978-50	Drawn by	R.Tamm	Material	28x114
	Date	21.08.2018	File	Pepe28.dwg
			Scale	1:40

The guide is illustrative. This guide is not project specification.
 Der Leitfaden ist illustrativ. Dieser Leitfaden ist keine Projektspezifikation.
 De gids is illustratief. Deze gids is geen projectspecificatie.

WA-1		1
WB-1		1

NB!

NB!

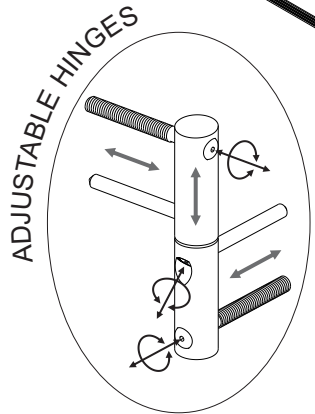
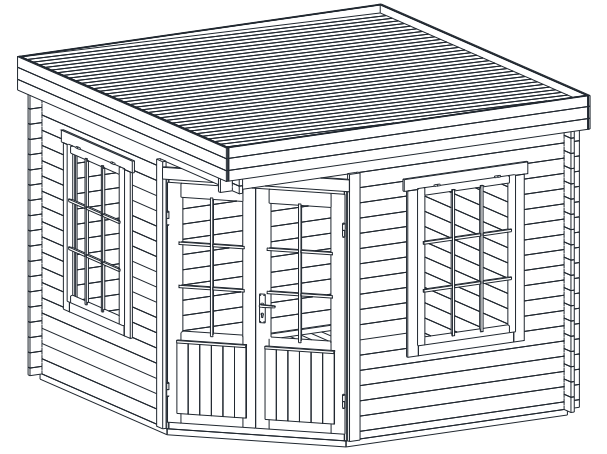

ADJUSTABLE HINGES

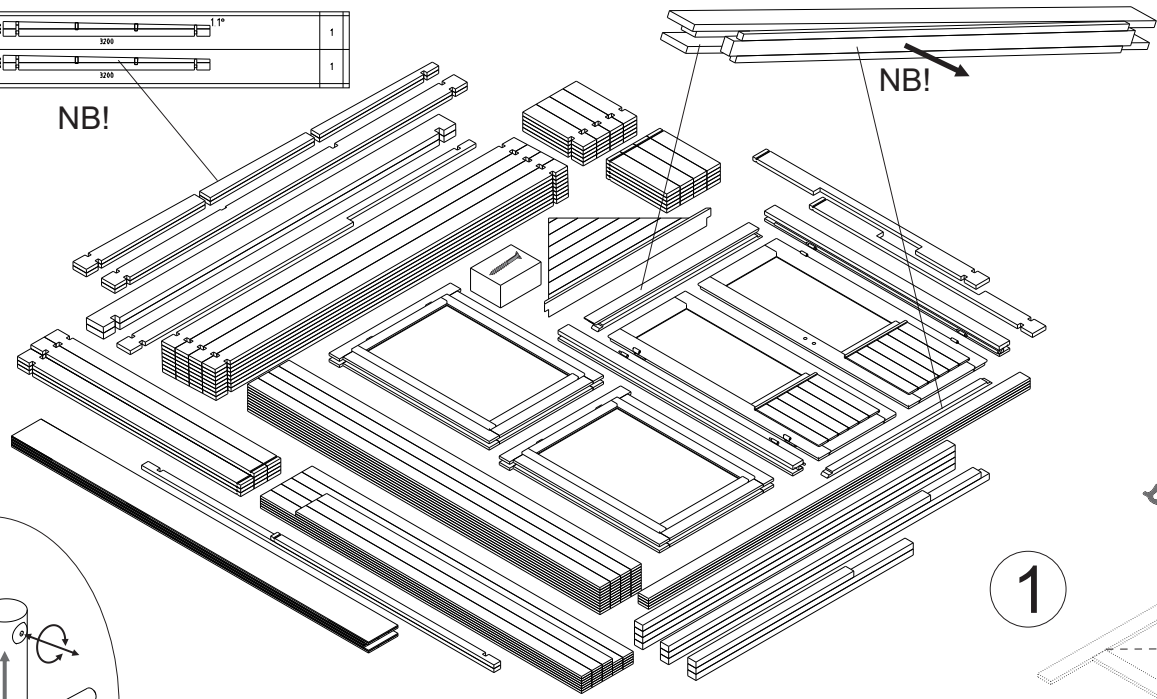

1

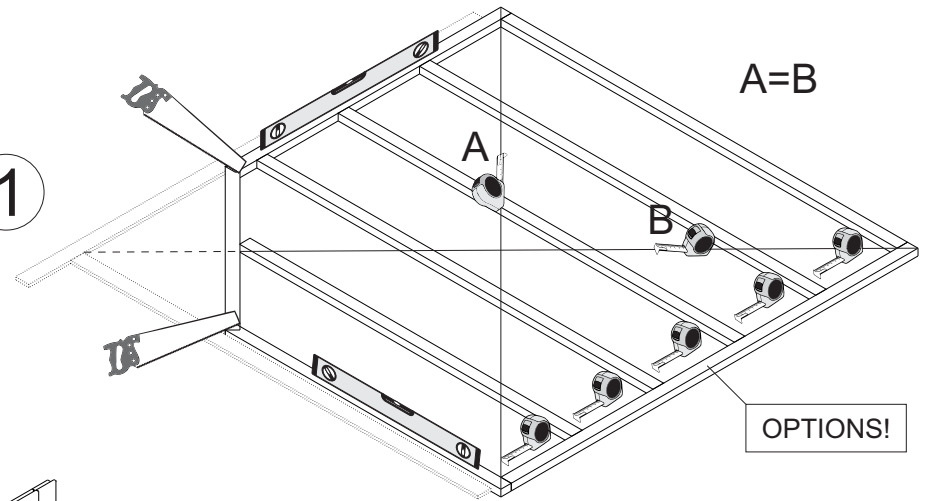

A=B

OPTIONS!

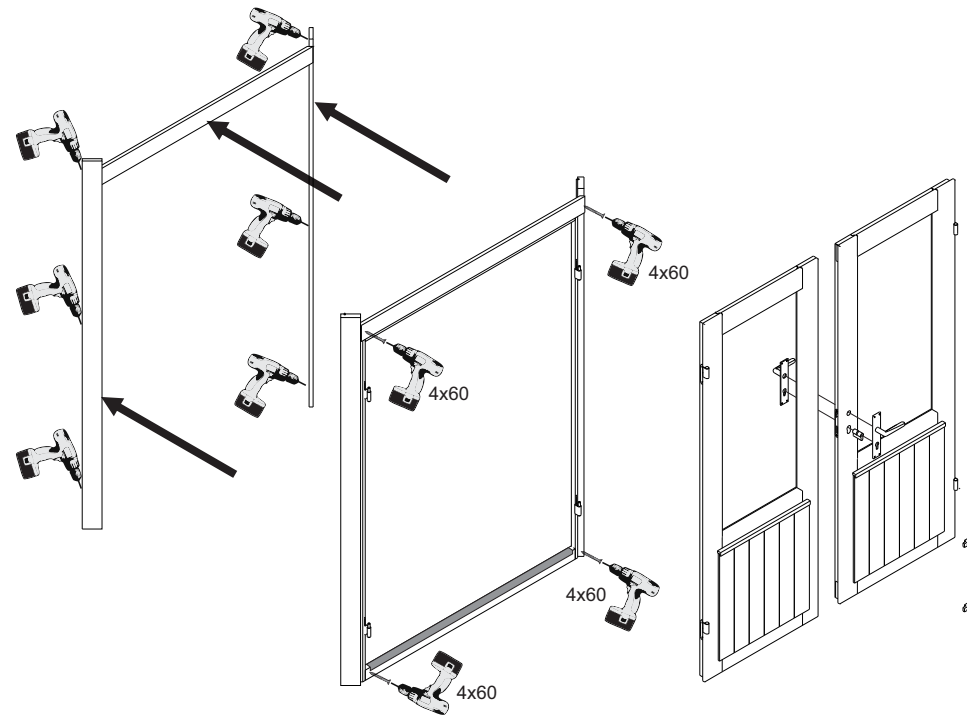

OPTIONS!

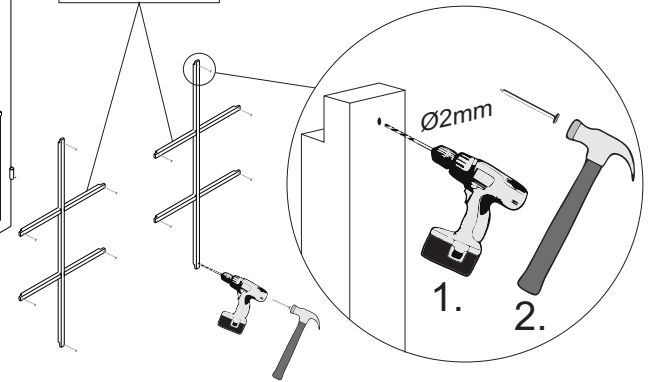

1.

2.

Ø2mm

2

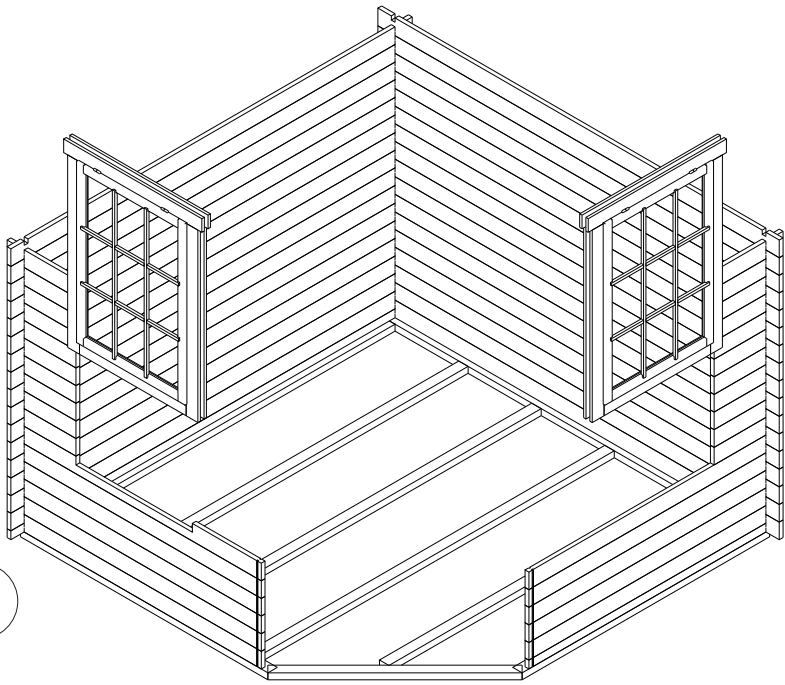

3

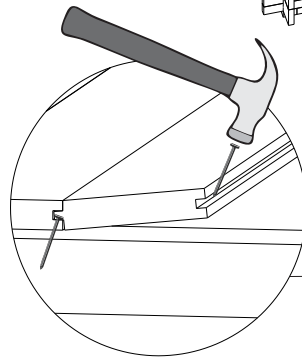
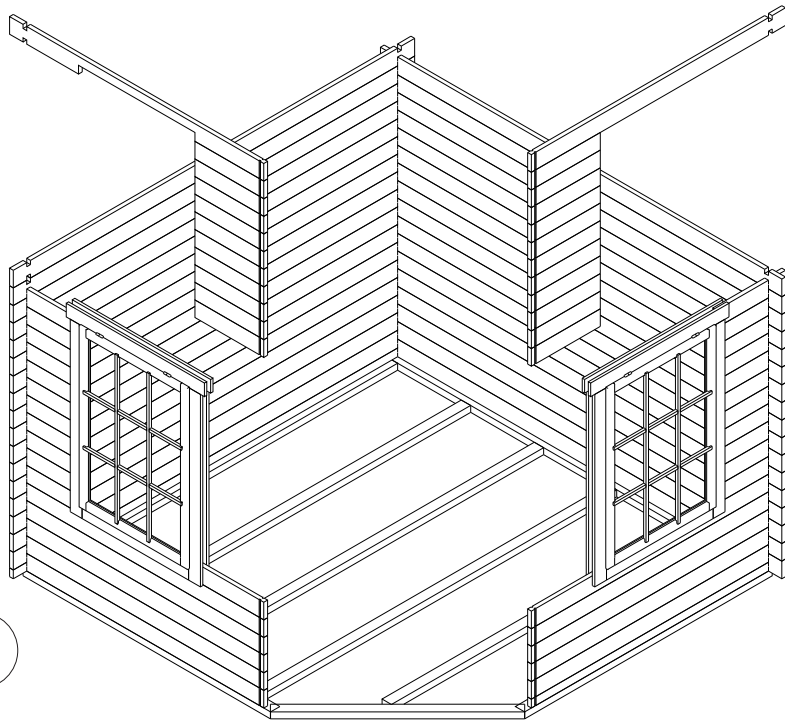

OPTIONS!

4

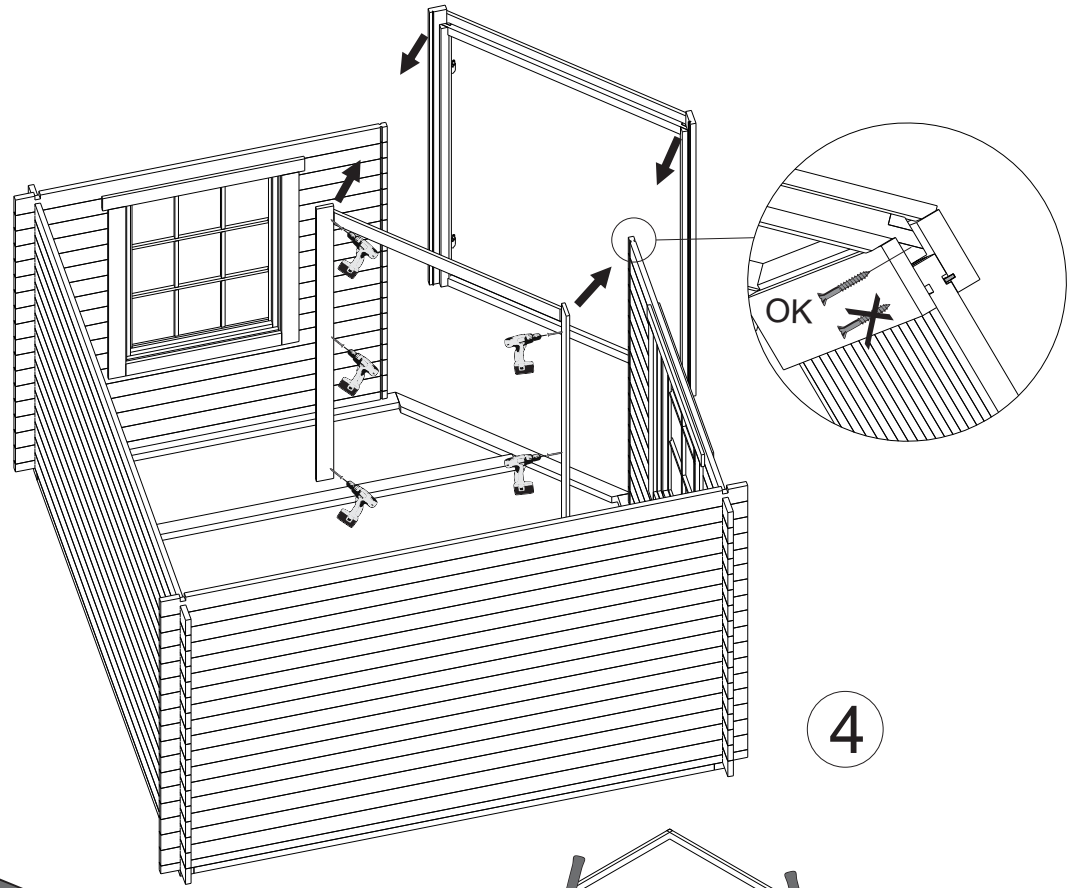

5

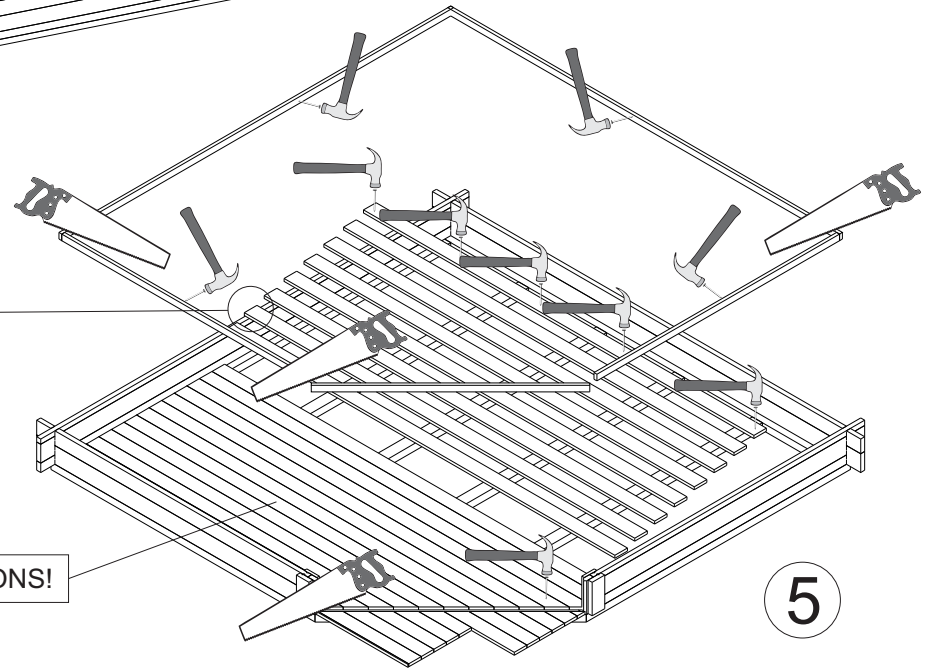

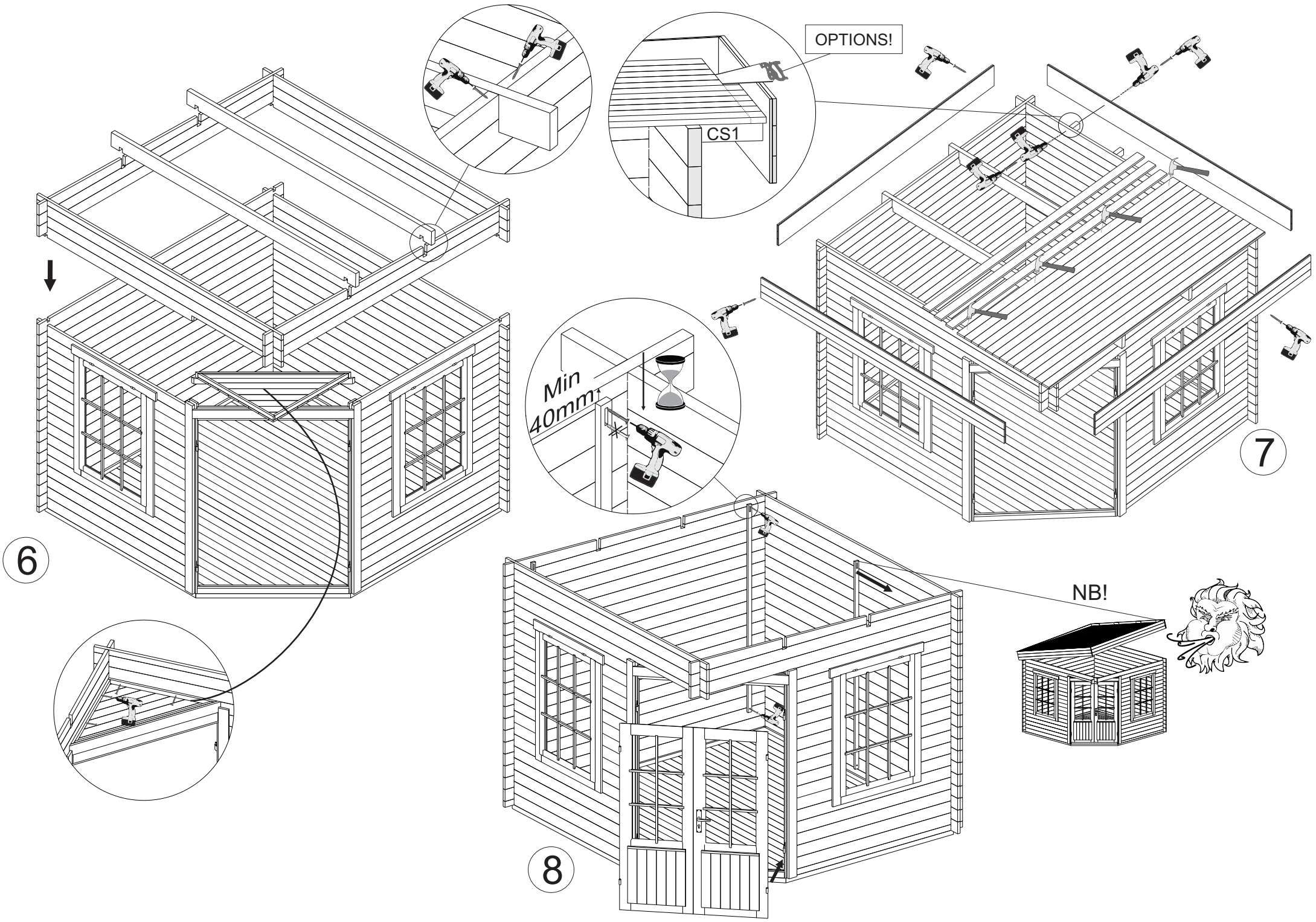

POST

