

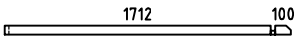

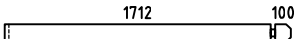







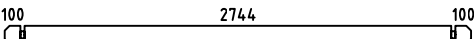
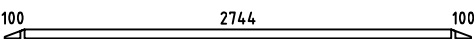
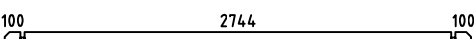
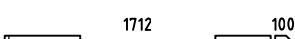
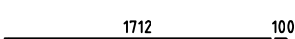
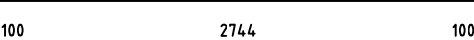
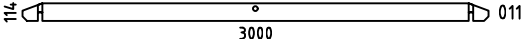
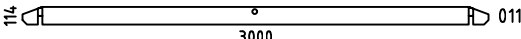
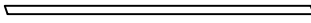
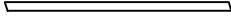

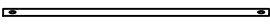







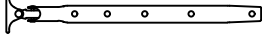

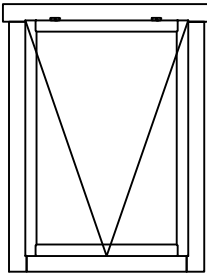
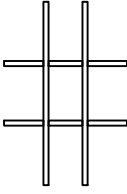
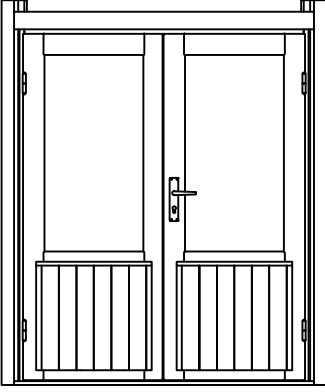
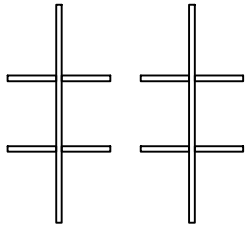
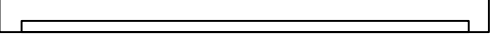

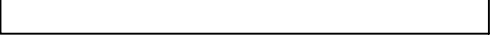

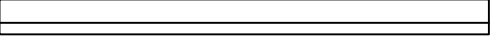
Monica28

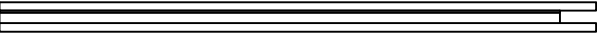
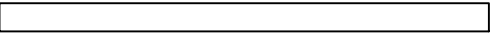
Pos	Specification-Spezifikation-Specificatie Monica28	St.	Profile (mm)	Length (mm)
001		1	28x57	1840
002		11	28x114	1840
003		21	28x114	485
004		21	28x114	485
005		37	28x114	3000
006		2	28x57	3000
007		1	28x57	3000
008		1	28x114	1840
009		1	28x114	1840
010		1	28x114	3000
WA-1		1		
WB-1		1		
SR2	RAFTER-DACHSPARREN-DAKSPAR 	4	44x55	1986
SR1	RAFTER-DACHSPARREN-DAKSPAR 	4	44x55	1458
	Eave Board-Traubret-Dakranden board 	4	18x70	3250
	Storm Brace-Sturmleiste 	3	18x40	2000
PE1	Ceiling Element-Deckenelement-Plafond Element 1 	1	931x1316	
	Double Door Set-Doppeltür Satz-Dubbele Deur Set  3x25 x2 4x60 x4	1		
	Nail-Nagel-Spijker 1.2x20 	30	1.2x20	
N1	Ridge piece-Firstelement-Nokstuk 	1		
DE1	Roof Panel-Dach Elemente-Dakpanelen 	4+4	1685x1590	
	Screw-Schraube-Schroef 4x60 	80		
	Ventilation Panel-Lüftungsgitter Set 	1		
WS1	Window Stay-Fensterfeststelle 	2		
HS1	Wood Bolt set-Holzschraubesatz-Hout Bout 8x80 	4		

Pos	Specification-Spezifikation-Specificatie Monica28			St.	Profile (mm)	Length (mm)
W9N 86.5 X122.5	<p>WINDOW 865x1225</p>  <p>Window Glazing Bar Fenstersprossen Raamroeden</p> 			2		
DD6P 141.5 x189.1	<p>DOOR 1415x1891</p>  <p>Door Glazing Bar Türsprossen Deuroeiden</p> 			1		
CORNER DOOR SET						
1	Top Jamb			1	58x42	1415
2	Threshold			1	58x42	1415
3-4	Vertical Jamb			2	58x42	1891
5-6	Post Set			1+1	42x61	2020
7-8	Cover Slat			2	40x18	1860
9-10	Casting			2	18x95	1500
	Screw-Schraube-Schroef 4x60			16		
	Screw-Schraube-Schroef 5x90			16		
Kood	GartenHaus GmbH	Materjal	File	Monica28.dwg	Leht	2/2

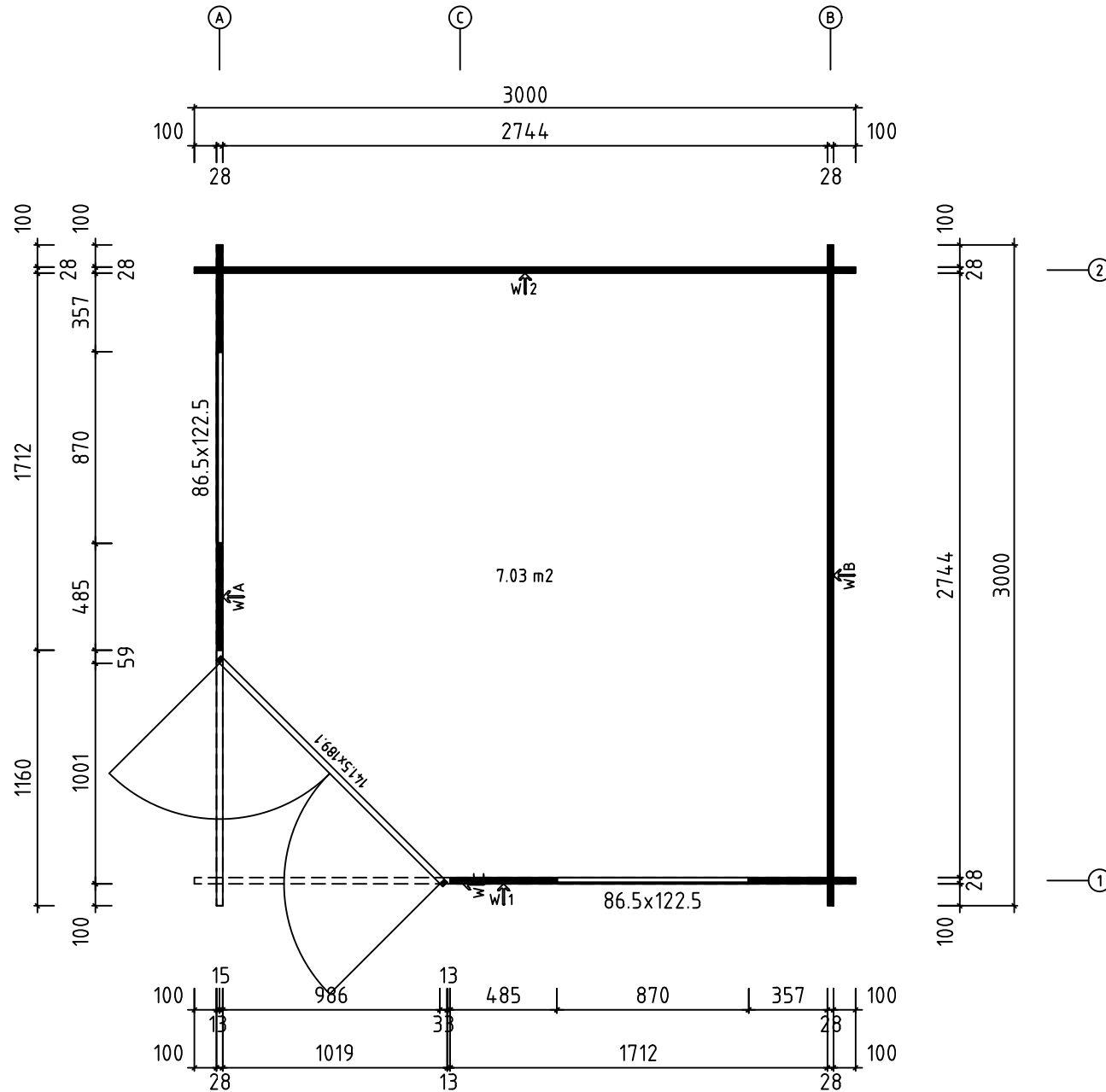
H = 1.500 m  
TOTAL: 7.05 m<sup>2</sup>



Model	Monica28	Drawing	PLAN	Page
 <a href="http://www.gartenhaus-gmbh.de">www.gartenhaus-gmbh.de</a> <a href="http://www.gartenhaus.at">www.gartenhaus.at</a> <a href="http://www.gartenhaus.ch">www.gartenhaus.ch</a> +49 (0) 40 537 9978-50	Drawn by	J.Soo	Material	28x114
	Date	22.01.2019	File	Monica28.dwg

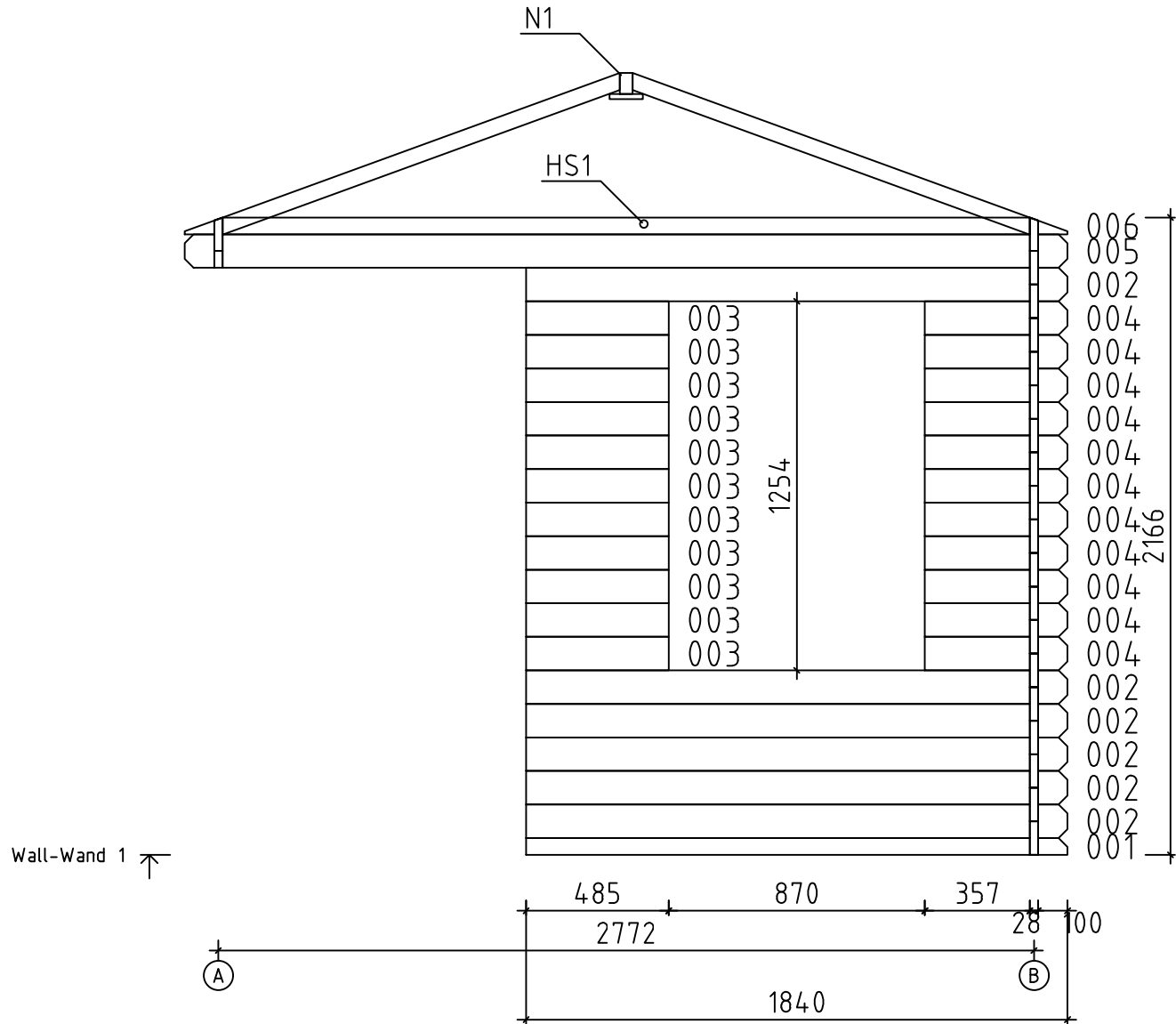

Model	Monica28	Drawing	WALL-WAND 1	Page	6	
 <a href="http://www.gartenhaus-gmbh.de">www.gartenhaus-gmbh.de</a> <a href="http://www.gartenhaus.at">www.gartenhaus.at</a> <a href="http://www.gartenhaus.ch">www.gartenhaus.ch</a> +49 (0) 40 537 9978-50	Drawn by	J.Soo	Material	2.8x11.4	Scale	1:20
	Date	22.01.2019	File	Monica28.dwg		

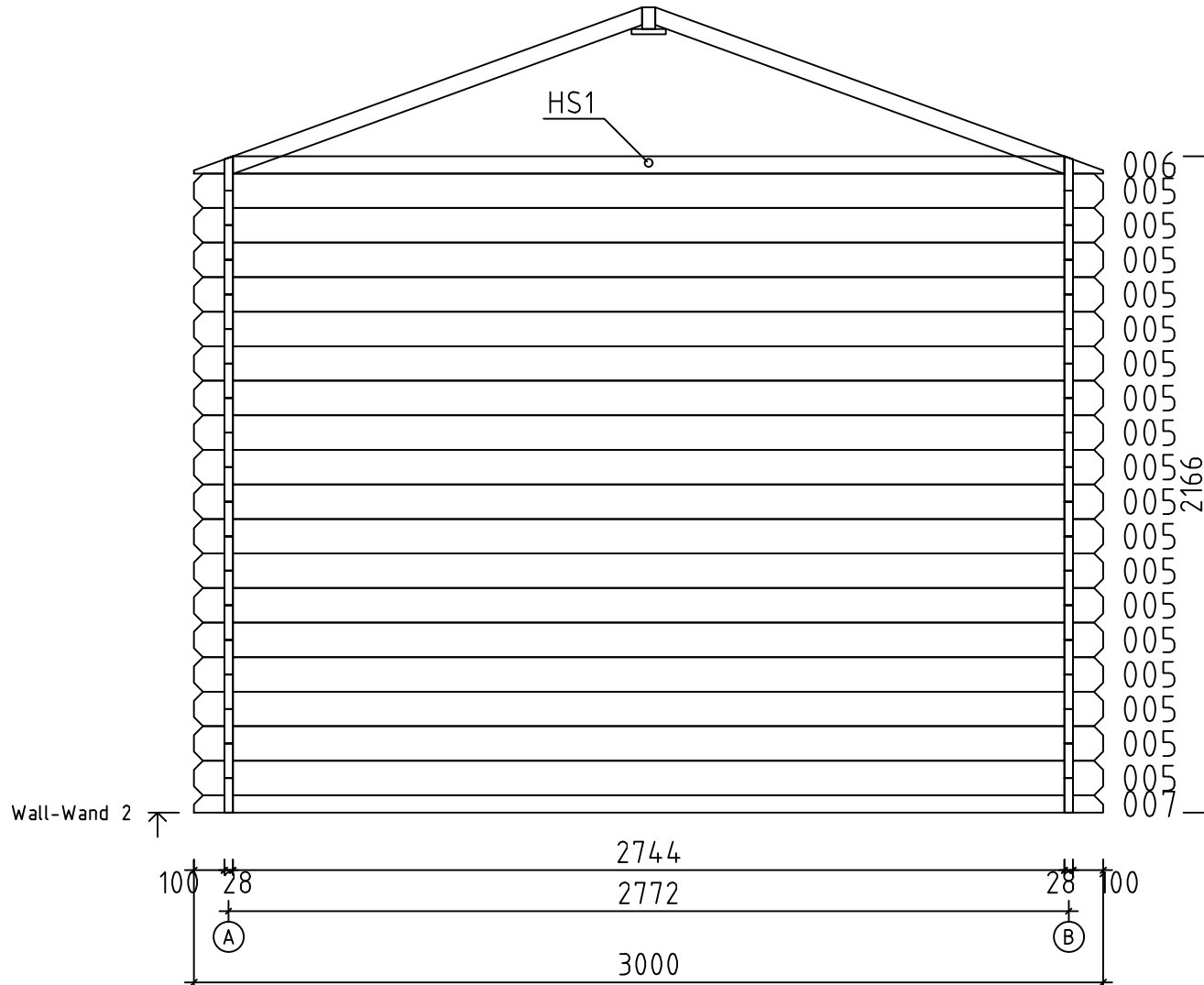

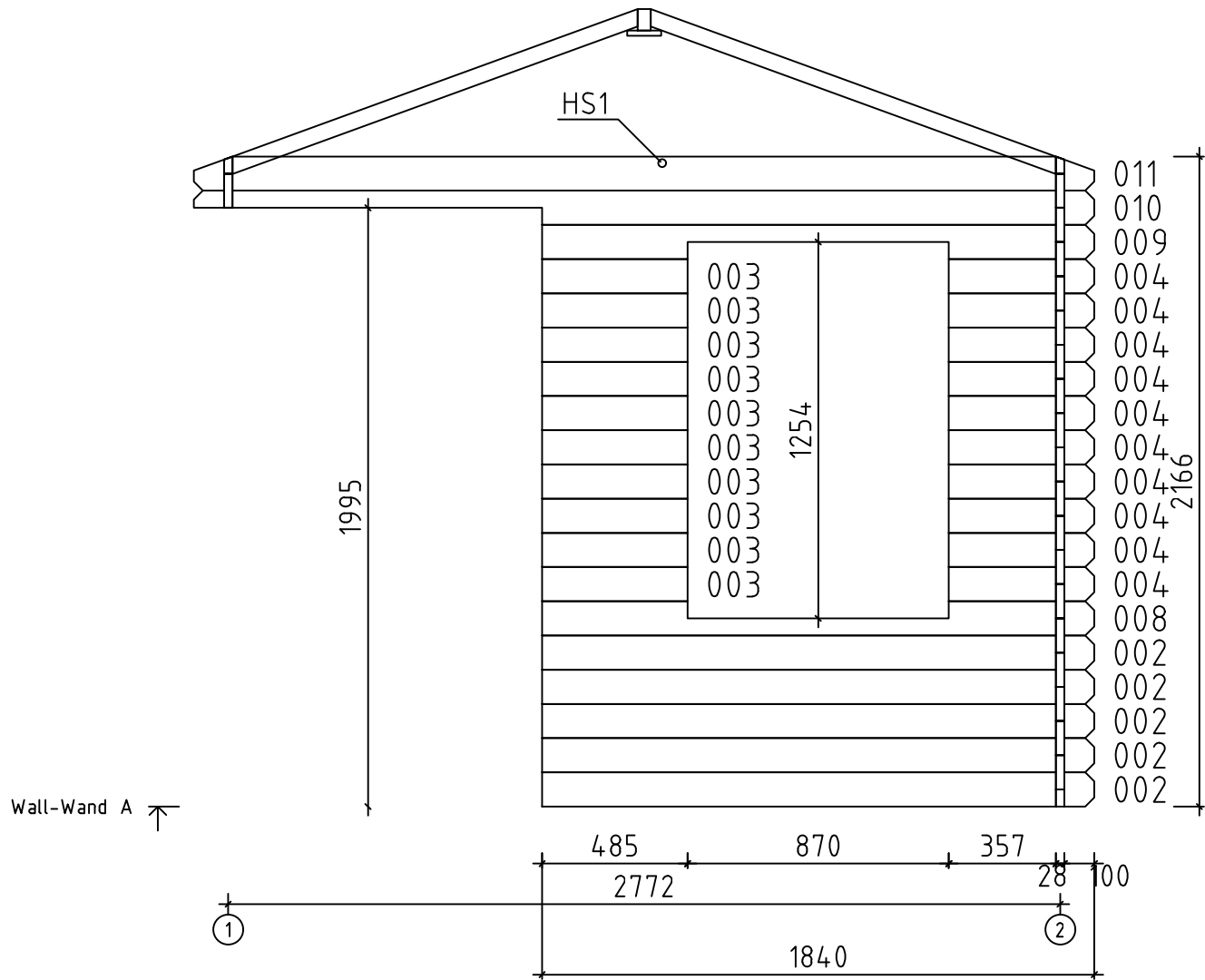

Model	Monica28	Drawing	WALL-WAND 2	Page	7	
 <a href="http://www.gartenhaus-gmbh.de">www.gartenhaus-gmbh.de</a> <a href="http://www.gartenhaus.at">www.gartenhaus.at</a> <a href="http://www.gartenhaus.ch">www.gartenhaus.ch</a> +49 (0) 40 537 9978-50	Drawn by	J.Soo	Material	2.8x11.4	Scale	1:20
	Date	22.01.2019	File	Monica28.dwg		

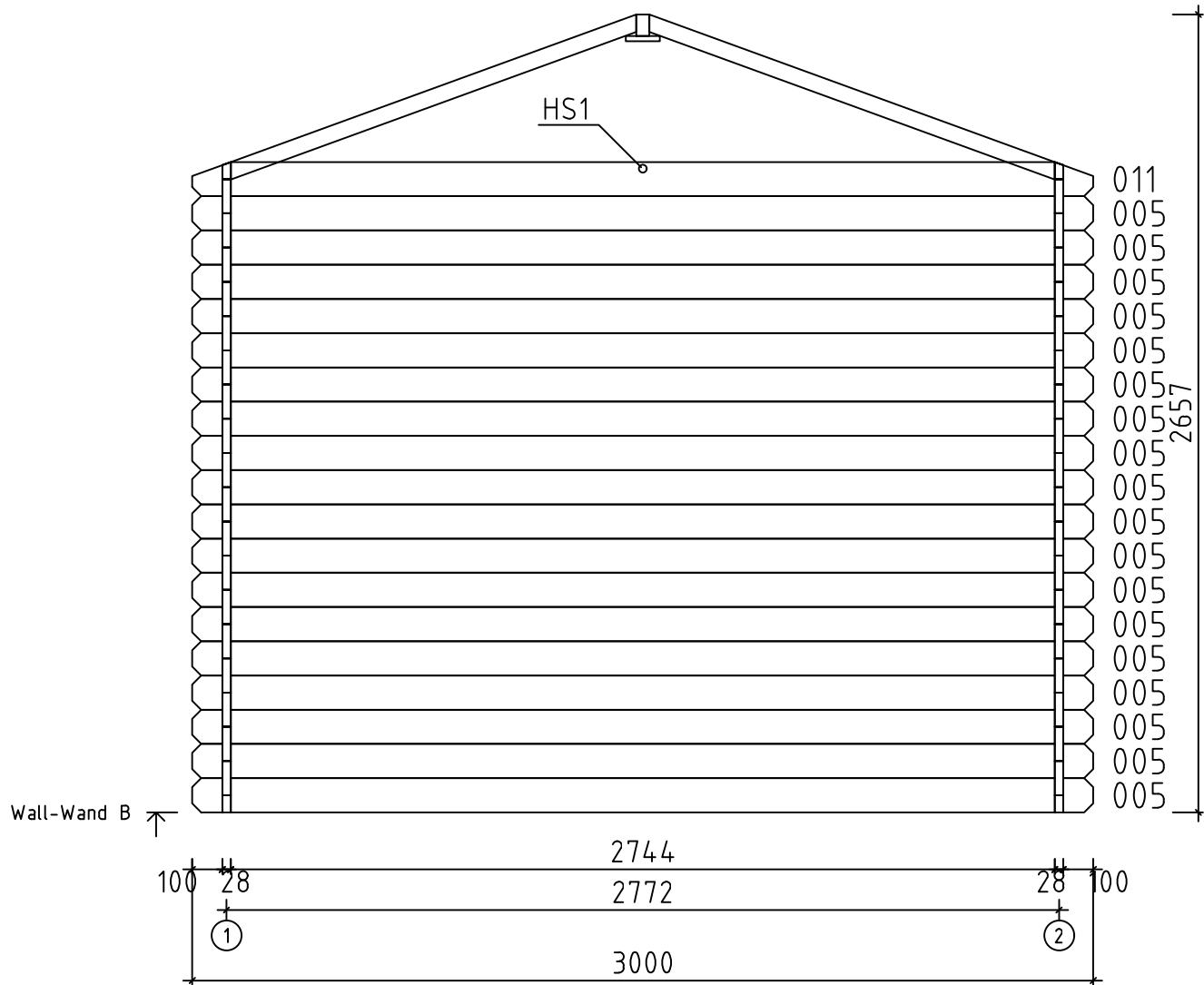

Wall-Wand A ↗

Model	Monica28	Drawing	WALL-WAND A	Page	3	
 <a href="http://www.gartenhaus-gmbh.de">www.gartenhaus-gmbh.de</a> <a href="http://www.gartenhaus.at">www.gartenhaus.at</a> <a href="http://www.gartenhaus.ch">www.gartenhaus.ch</a> +49 (0) 40 537 9978-50	Drawn by	J.Soo	Material	2.8x11.4	Scale	1:20
	Date	22.01.2019	File	Monica28.dwg		



Model	Monica28	Drawing	WALL-WAND B	Page	4	
 <a href="http://www.gartenhaus-gmbh.de">www.gartenhaus-gmbh.de</a> <a href="http://www.gartenhaus.at">www.gartenhaus.at</a> <a href="http://www.gartenhaus.ch">www.gartenhaus.ch</a> +49 (0) 40 537 9978-50	Drawn by	J.Soo	Material	2.8x11.4	Scale	1:20
	Date	22.01.2019	File	Monica28.dwg		



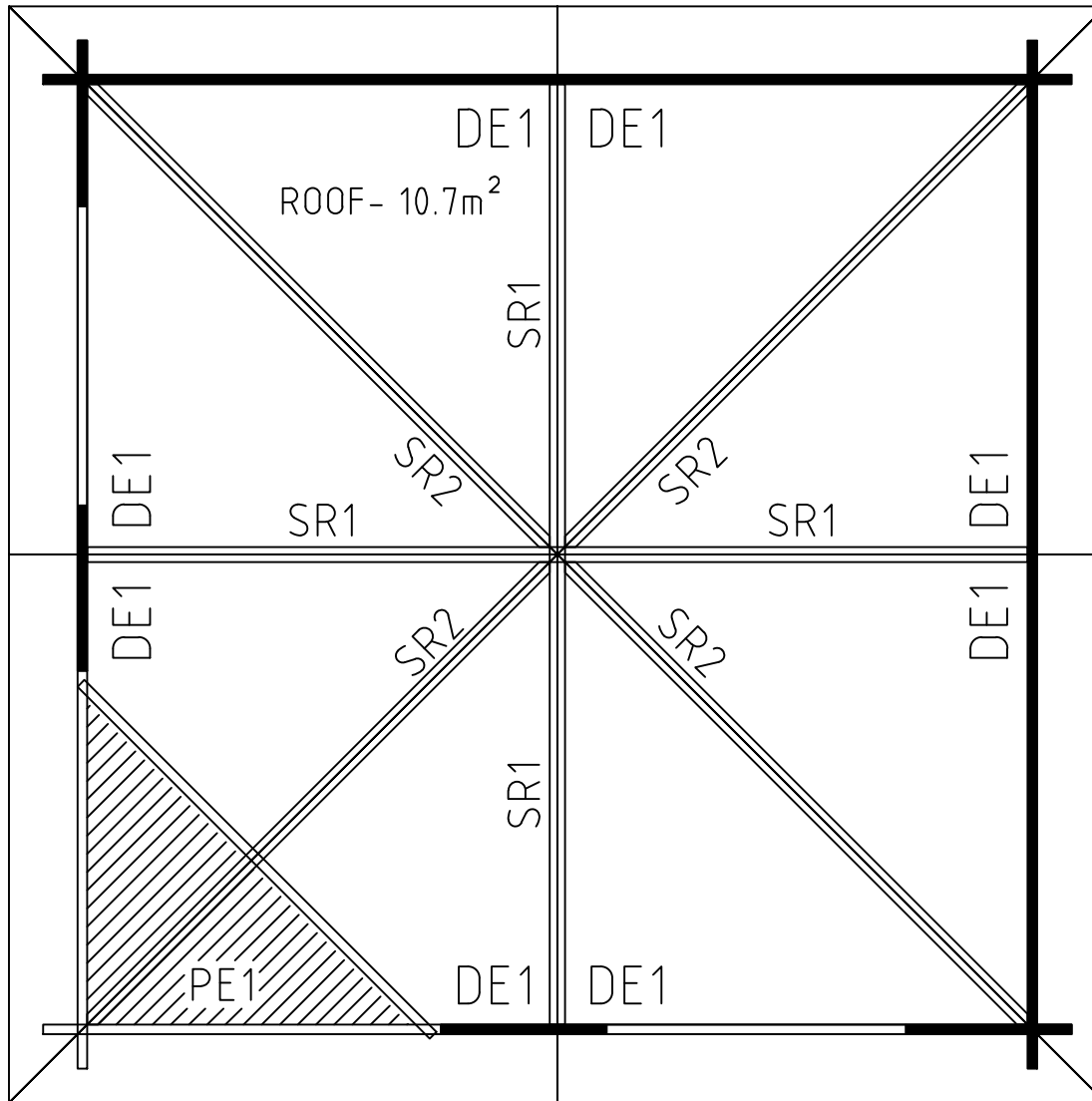

Model	Monica28	Drawing	ROOF	Page
 <a href="http://www.gartenhaus-gmbh.de">www.gartenhaus-gmbh.de</a> <a href="http://www.gartenhaus.at">www.gartenhaus.at</a> <a href="http://www.gartenhaus.ch">www.gartenhaus.ch</a> +49 (0) 40 537 9978-50	Drawn by	J.Soo	Material	28x114
	Date	22.01.2019	File	Monica28.dwg
			Scale	1:20

The guide is illustrative. This guide is not project specification.  
Der Leitfaden ist illustrativ. Dieser Leitfaden ist keine Projektspezifikation.  
De gids is illustratief. Deze gids is geen projectspecificatie.

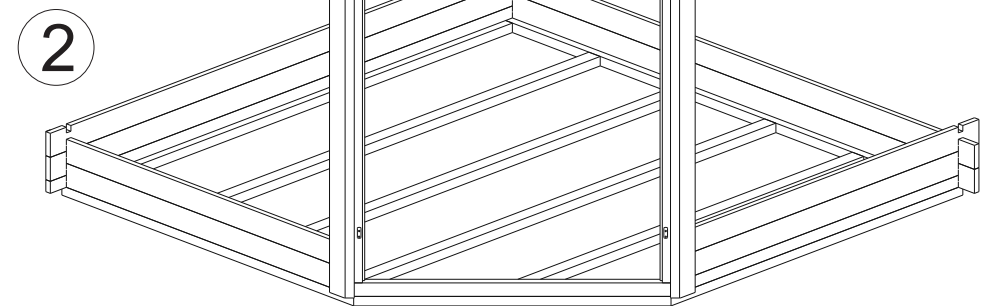
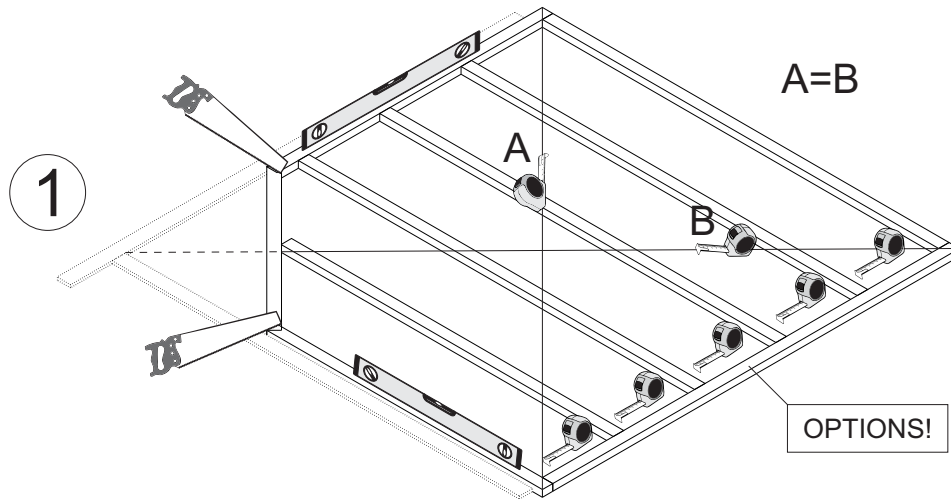
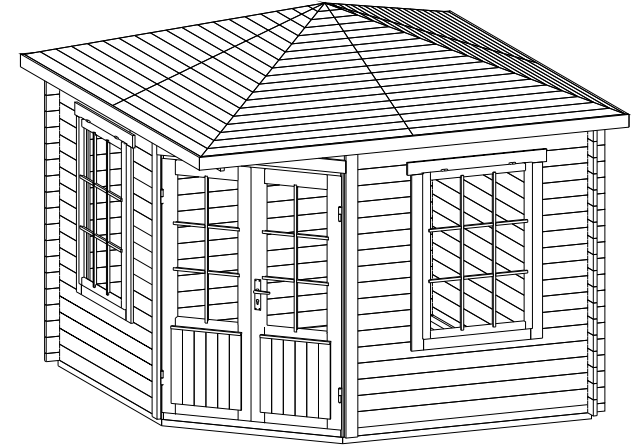
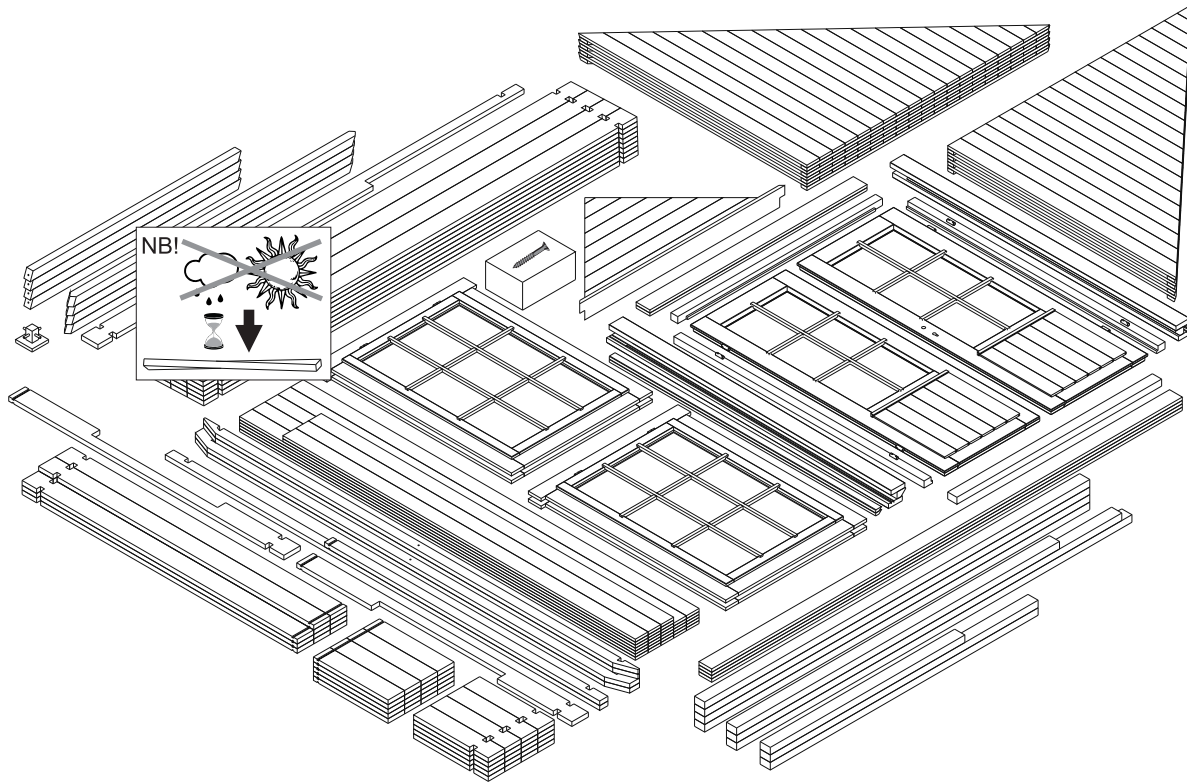

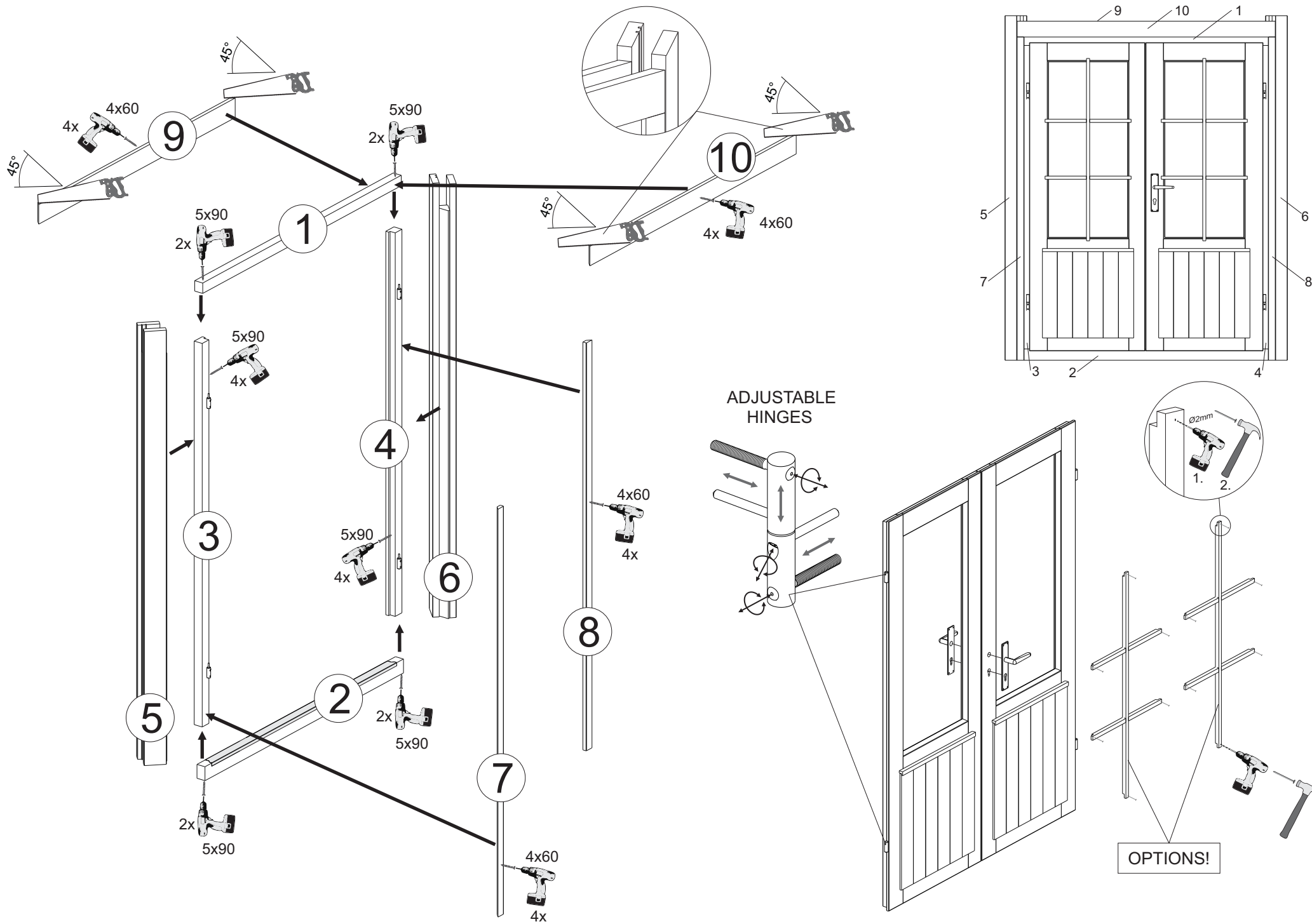

3

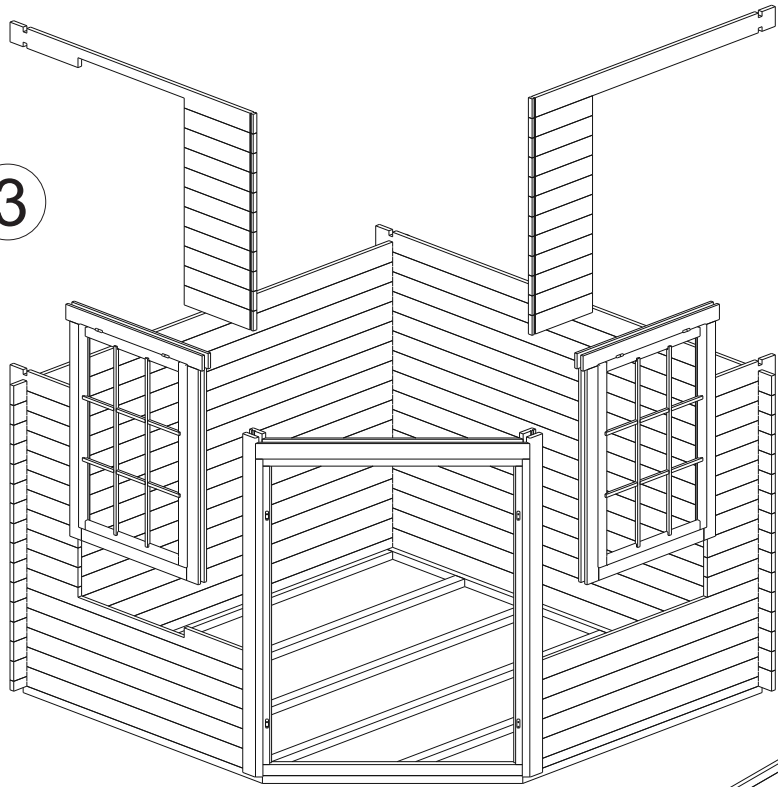

5

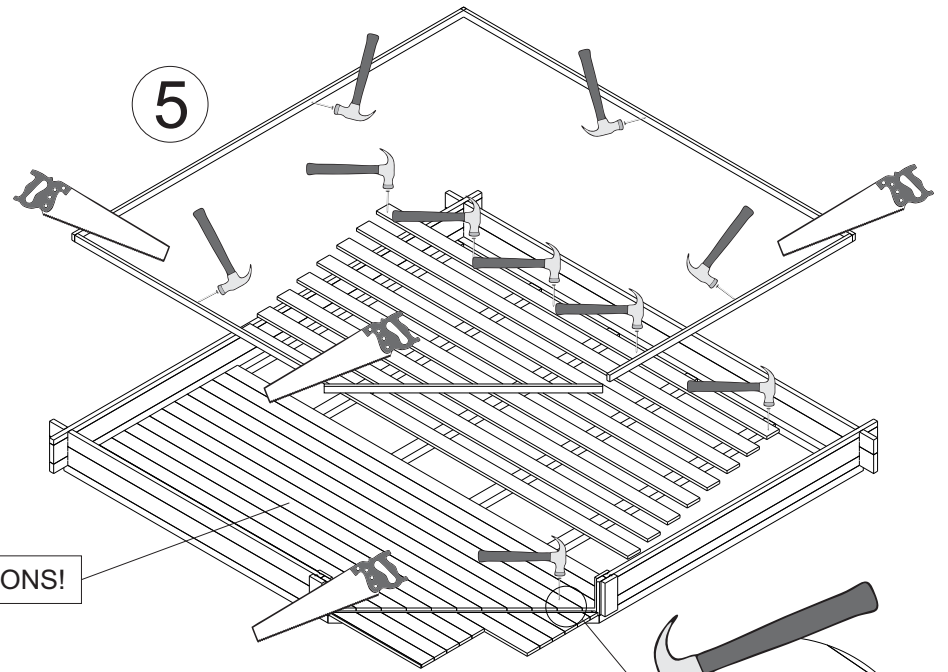

OPTIONS!

4

