

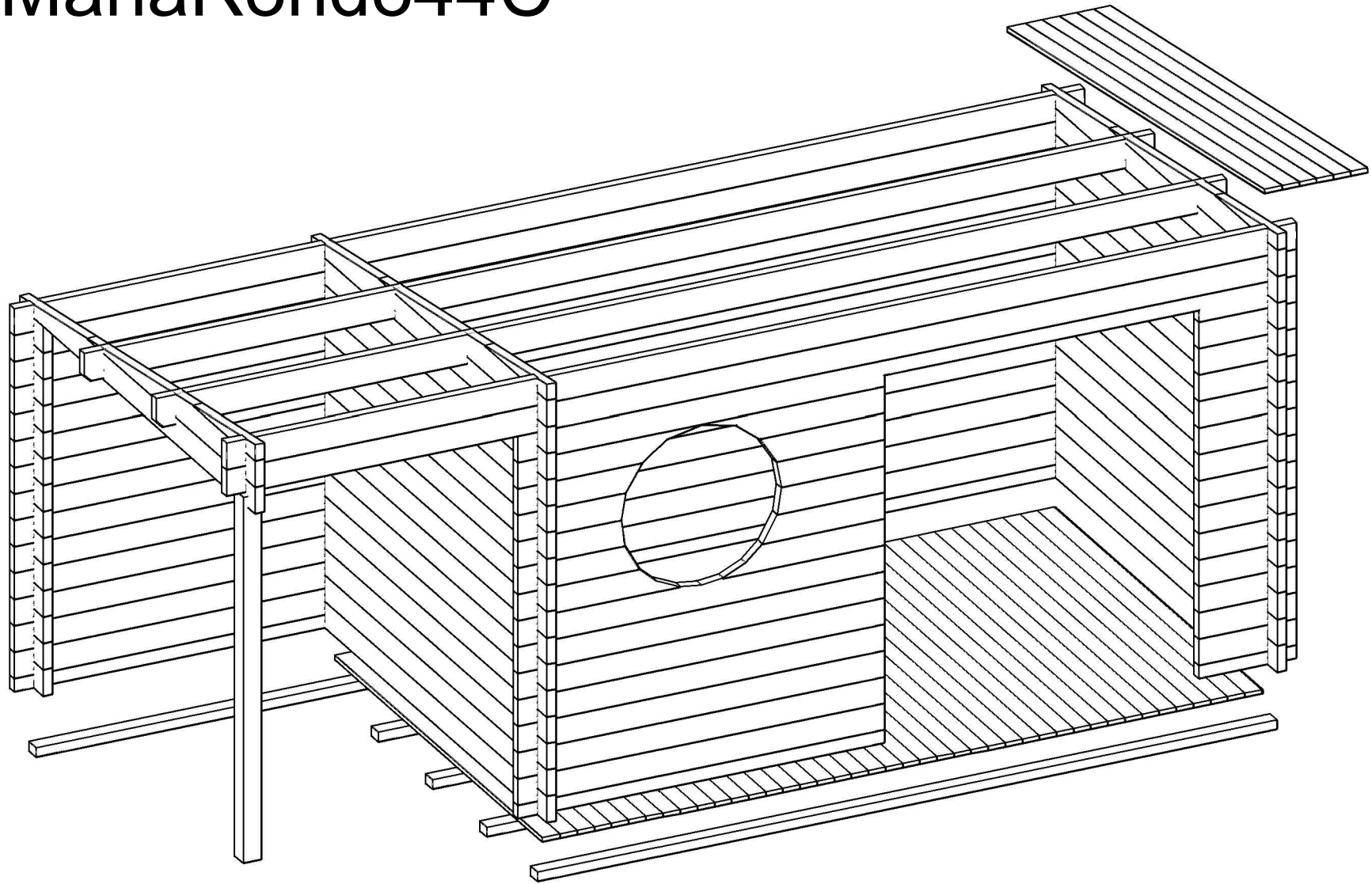

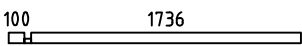







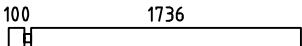

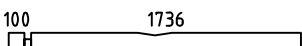
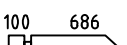
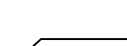







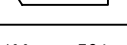
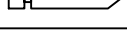
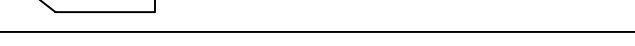
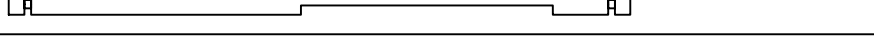
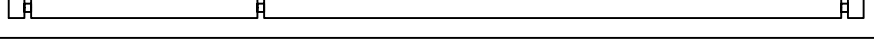
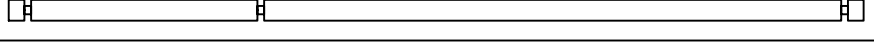
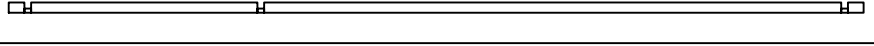

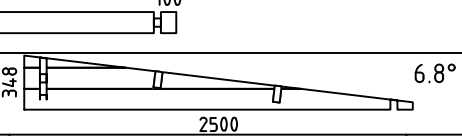
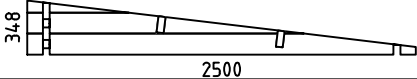
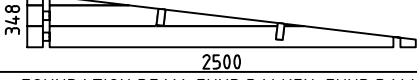

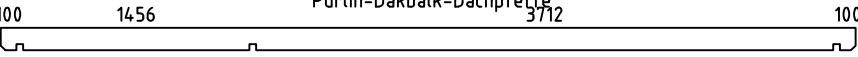
MariaRondo44C

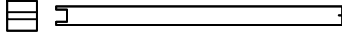

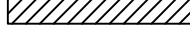
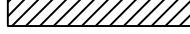
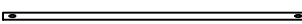
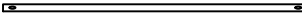

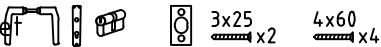
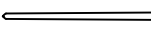
Pos	Specification-Spezifikation-Specificatie MariaRondo44C ISO	St.	Profile (mm)	Length (mm)
001		1	44x68	1880
002		1	44x68	500
003		6	44x135	1880
004		13	44x135	500
005		1	44x135	1880
006		1	44x135	830
007		1	44x135	830
008		1	44x135	622
009		1	44x135	622
010		1	44x135	548
011		1	44x135	548
012		1	44x135	553
013		1	44x135	553
014		1	44x135	639
015		1	44x135	639
016		1	44x135	940
017		1	44x135	940
018		1	44x135	4000
019		14	44x135	5500
020		1	44x134	5500
021		1	44x68	5500
022		1	44x134	5500
023		14	44x135	244
027		28	44x135	2500
WA-1		1		

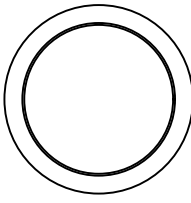
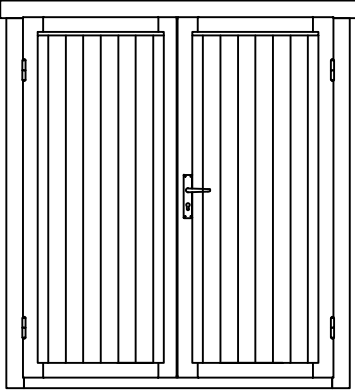
Pos	Specification-Spezifikation-Specificatie MariaRondo44C ISO	St.	Profile (mm)	Length (mm)
WB-1		1		
WC-1		1		
FB1	FOUNDATION BEAM-FUND.BALKEN-FUND.BALK 	1	70x45	5300
FB2	FOUNDATION BEAM-FUND.BALKEN-FUND.BALK 	4	70x45	3800
PR1	Purlin-Dakbalk-Dachpfette 	2	44x144	5500
	Floor board-Fussbodenbrett-Vloerplank 	43	88x18	2202
DP1	Roof board-Dachbrett-Dakplank 	63	88x18	2750
	-POST 85x85 	1		1935
	Base Board-Fussbleiste-Plinten 18x40x3000 	3	18x40	9rmt.
L2	Eave Board-Traufenblende-Afdeklank 	2	18x120	2790
L1	Facia Board-Giebelblende-Gevelplank 	4	18x120	2768
	Storm Brace-Sturmleiste 	2	18x40	1820
	Storm Brace-Sturmleiste 	2	18x40	2000
	Adjustable foot-Stellfuß+Schrauben 4x50 4stück für Post 	1		
	Double Door Set-Doppeltür Satz-Dubbele Deur Set 	1		
	Nail-Nagel-Spijker 	510		
	Ventilation Panel-Lüftungsgitter Set 	1		
	Wood Bolt set for Storm Brace-Holzschraubensatz für Sturmleisten 6x45 	8		
W O R O U N D 8 2 5	WINDOW 860x860 ISO 	1		
Code	GartenHaus GmbH	Material	File	MariaRondo44C.dwg
			Page	2/3

Pos	Specification-Spezifikation-Specificatie MariaRondo44C ISO	St.	Profile (mm)	Length (mm)
DDL 1 60X185	<p style="text-align: center;">DOOR 1600x1850</p> 	1		
Code	GartenHaus GmbH	Material	File	MariaRondo44C.dwg
Page			3/3	

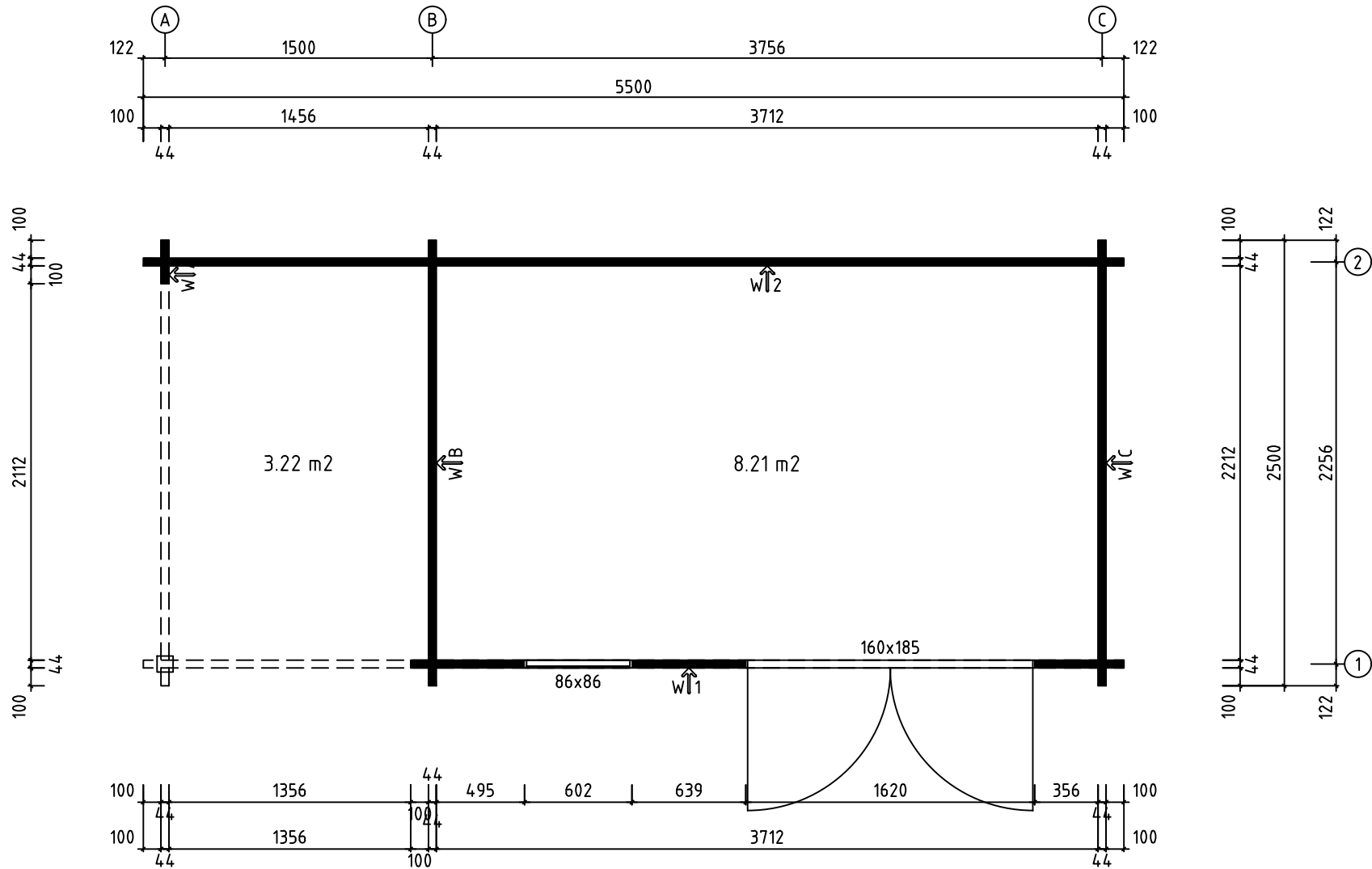
TOTAL: 11.43 m²



Model	MariaRondo44C ISO		Drawing	PLAN	Page
 www.gartenhaus-gmbh.de www.gartenhaus.at www.gartenhaus.ch +49 (0) 40 537 9978-50	Drawn by	R.Tamm	Material	44x135	Scale
	Date	29.03.2017	File	MariaRondo44C.dwg	

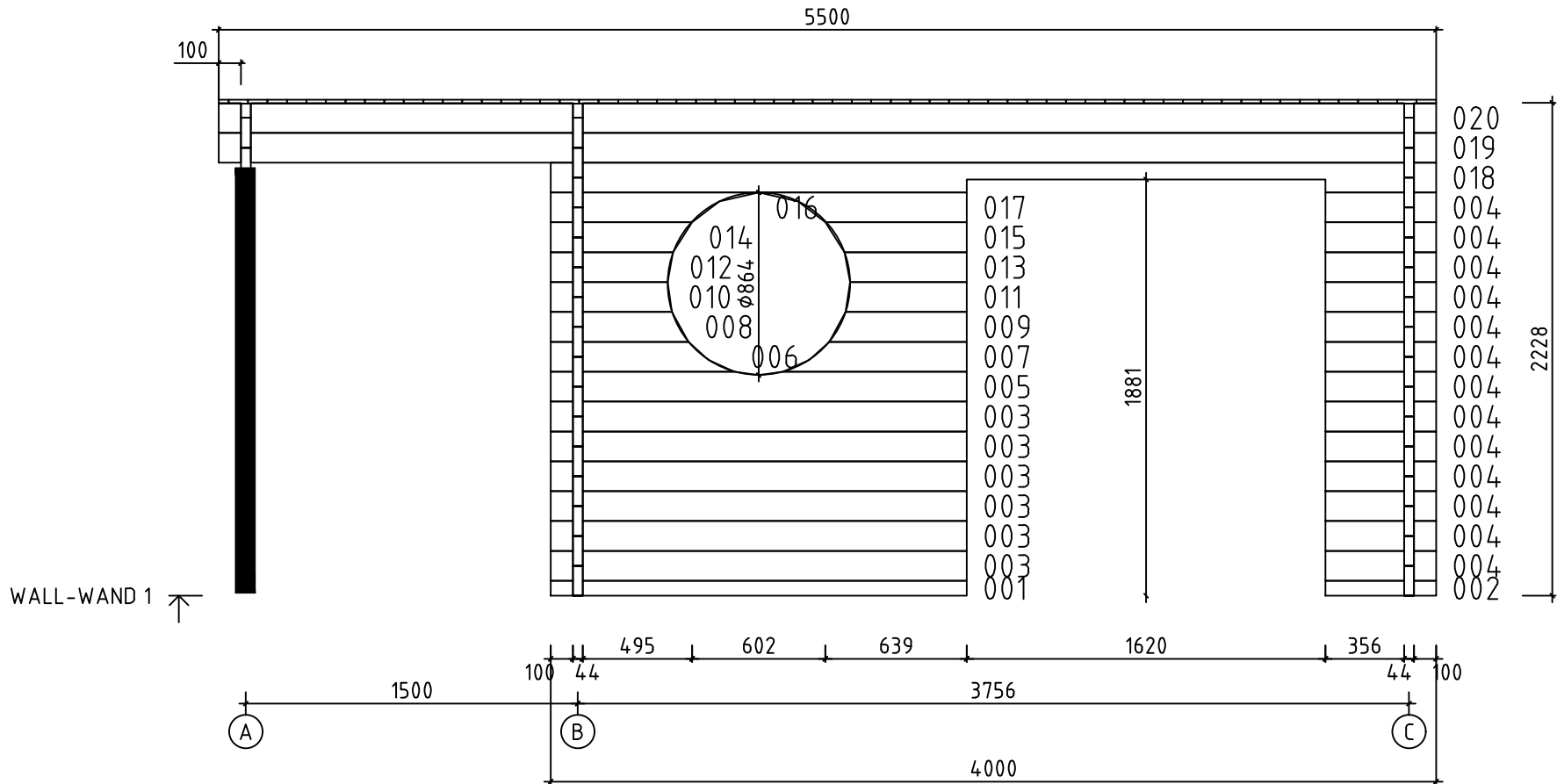

Model	MariaRondo44C ISO	Drawing	WALL-WAND 1	Page	5	
 www.gartenhaus-gmbh.de www.gartenhaus.at www.gartenhaus.ch +49 (0) 40 537 9978-50	Drawn by	R.Tamm	Material	4.4x13.5	Scale	1:30
	Date	29.03.2017	File	MariaRondo44C.dwg		

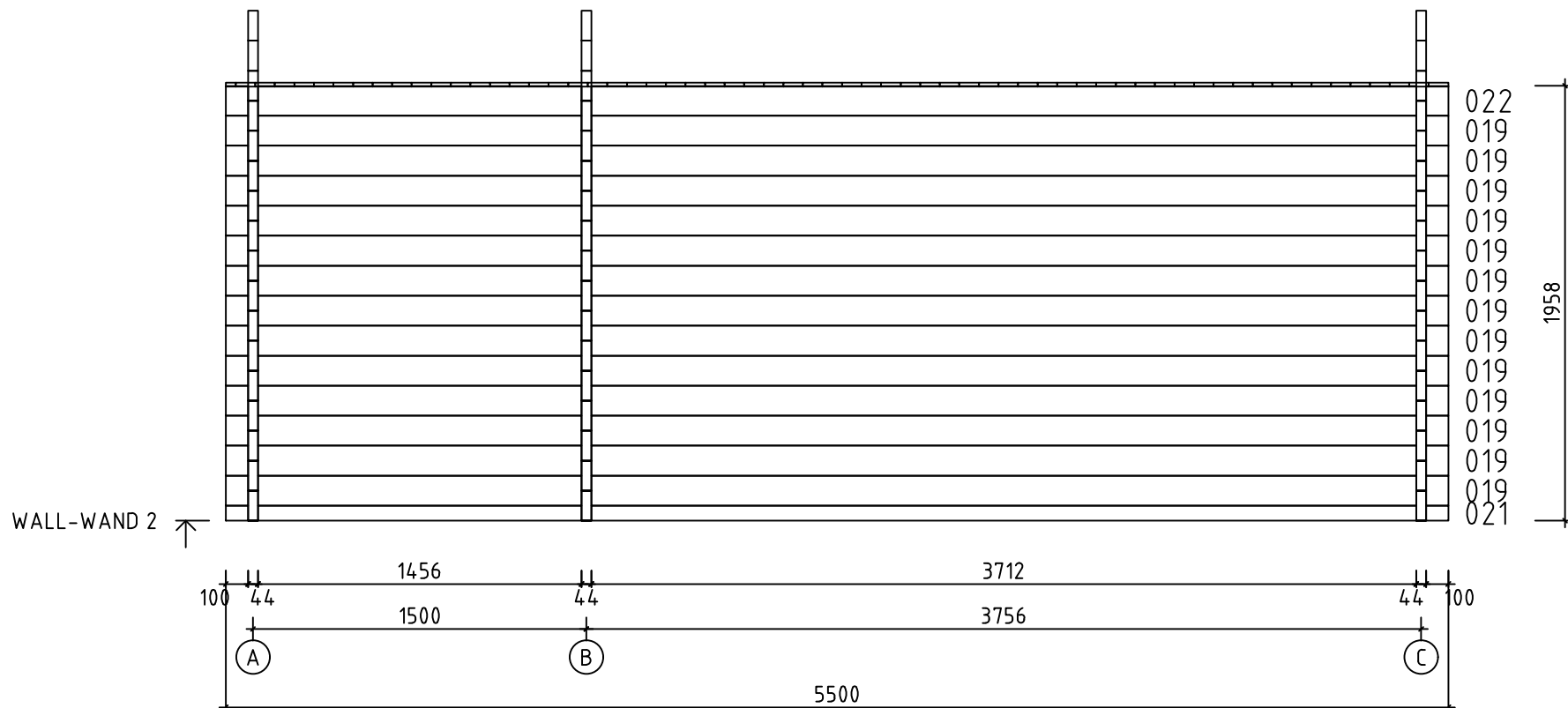

Model	MariaRondo44C ISO	Drawing	WALL-WAND 2	Page	6	
 www.gartenhaus-gmbh.de www.gartenhaus.at www.gartenhaus.ch +49 (0) 40 537 9978-50	Drawn by	R.Tamm	Material	4.4x13.5	Scale	1:30
	Date	29.03.2017	File	MariaRondo44C.dwg		

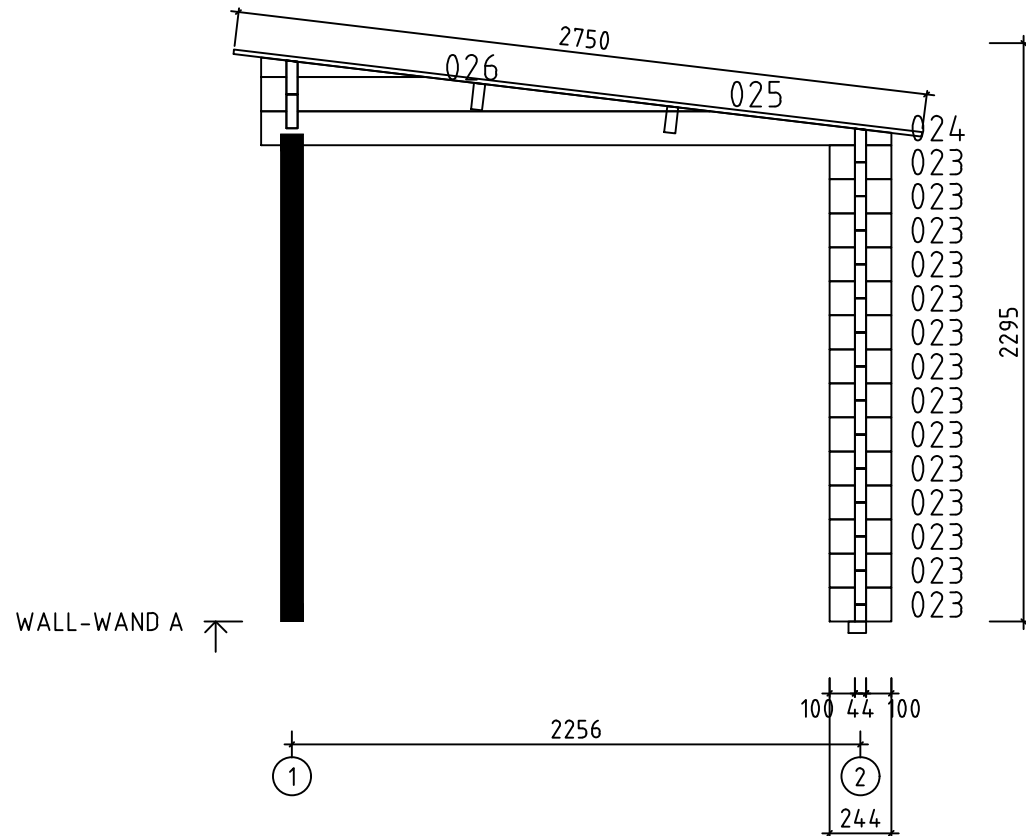

Model	MariaRondo44C ISO	Drawing	WALL-WAND A	Page	2	
 www.gartenhaus-gmbh.de www.gartenhaus.at www.gartenhaus.ch +49 (0) 40 537 9978-50	Drawn by	R.Tamm	Material	4.4x13.5	Scale	1:30
	Date	29.03.2017	File	MariaRondo44C.dwg		

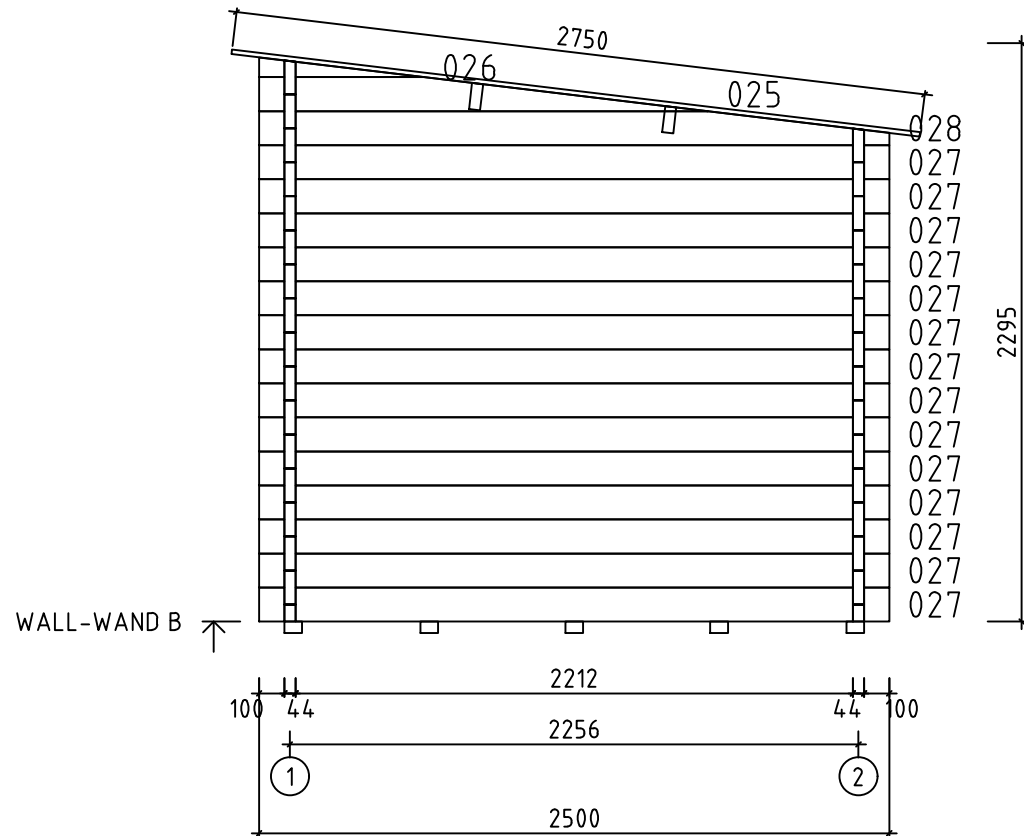

Model	MariaRondo44C ISO	Drawing	WALL-WAND B	Page	3	
 www.gartenhaus-gmbh.de www.gartenhaus.at www.gartenhaus.ch +49 (0) 40 537 9978-50	Drawn by	R.Tamm	Material	4.4x13.5	Scale	1:30
	Date	29.03.2017	File	MariaRondo44C.dwg		

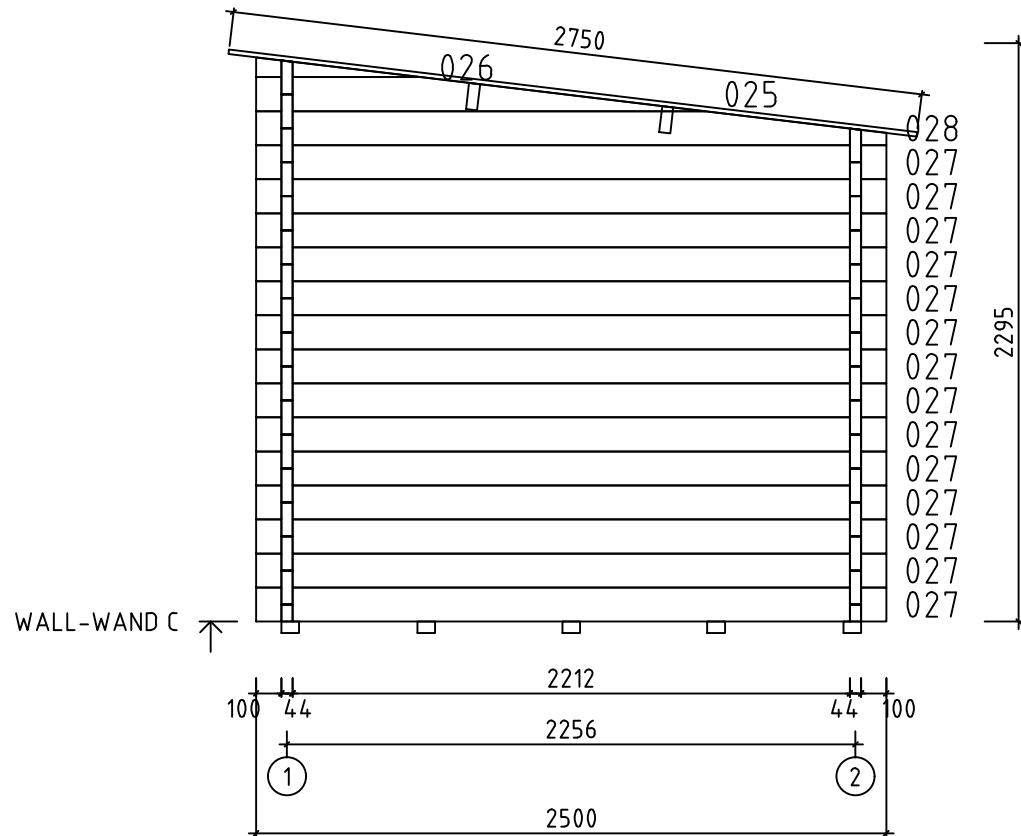

Model	MariaRondo44C ISO	Drawing	WALL-WAND C	Page	4	
 www.gartenhaus-gmbh.de www.gartenhaus.at www.gartenhaus.ch +49 (0) 40 537 9978-50	Drawn by	R.Tamm	Material	4.4x13.5	Scale	1:30
	Date	29.03.2017	File	MariaRondo44C.dwg		

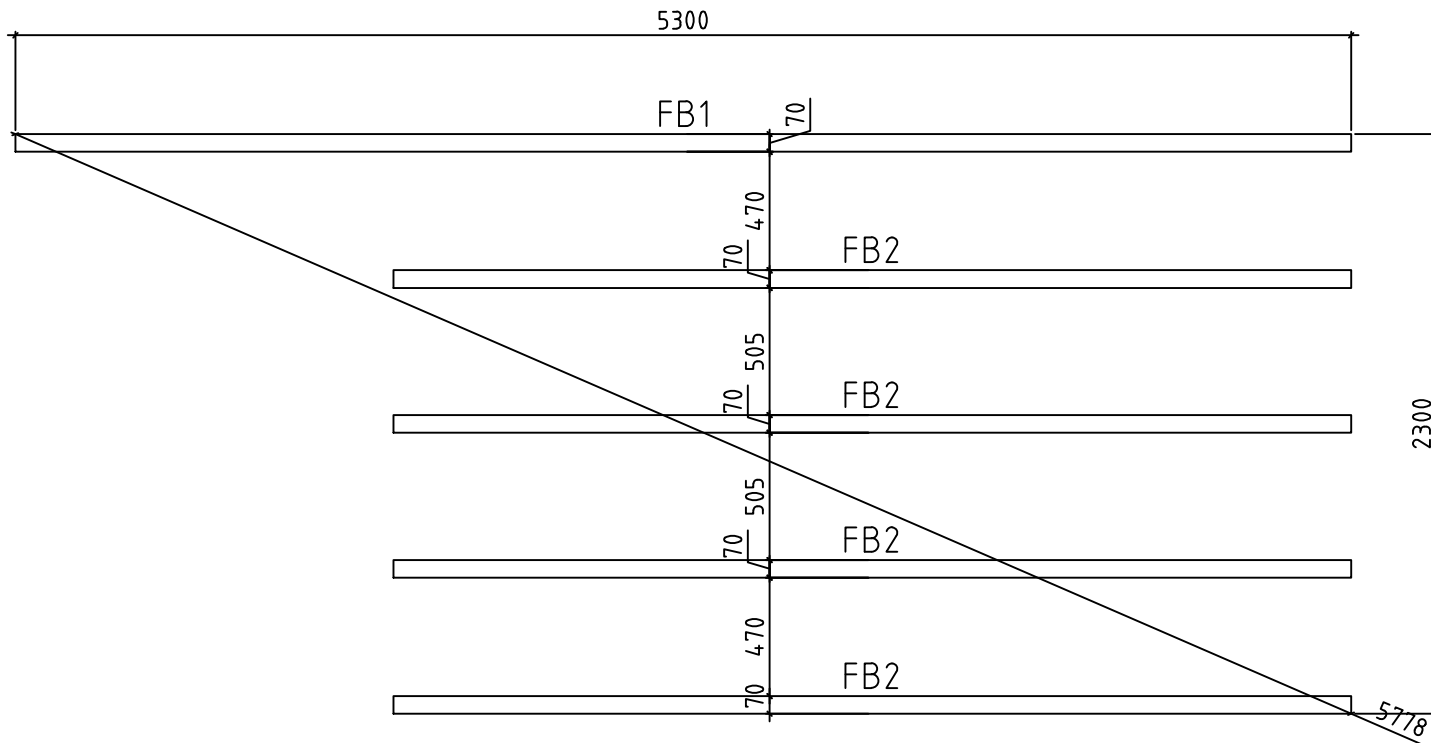

Model	MariaRondo44C ISO	Drawing	FOUNDATION	Page
 www.gartenhaus-gmbh.de www.gartenhaus.at www.gartenhaus.ch +49 (0) 40 537 9978-50	Drawn by	R.Tamm	Material	44x135
	Date	29.03.2017	File	MariaRondo44C.dwg
				Scale 1:30

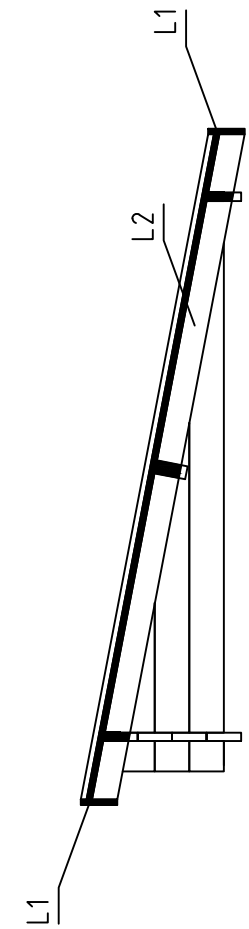
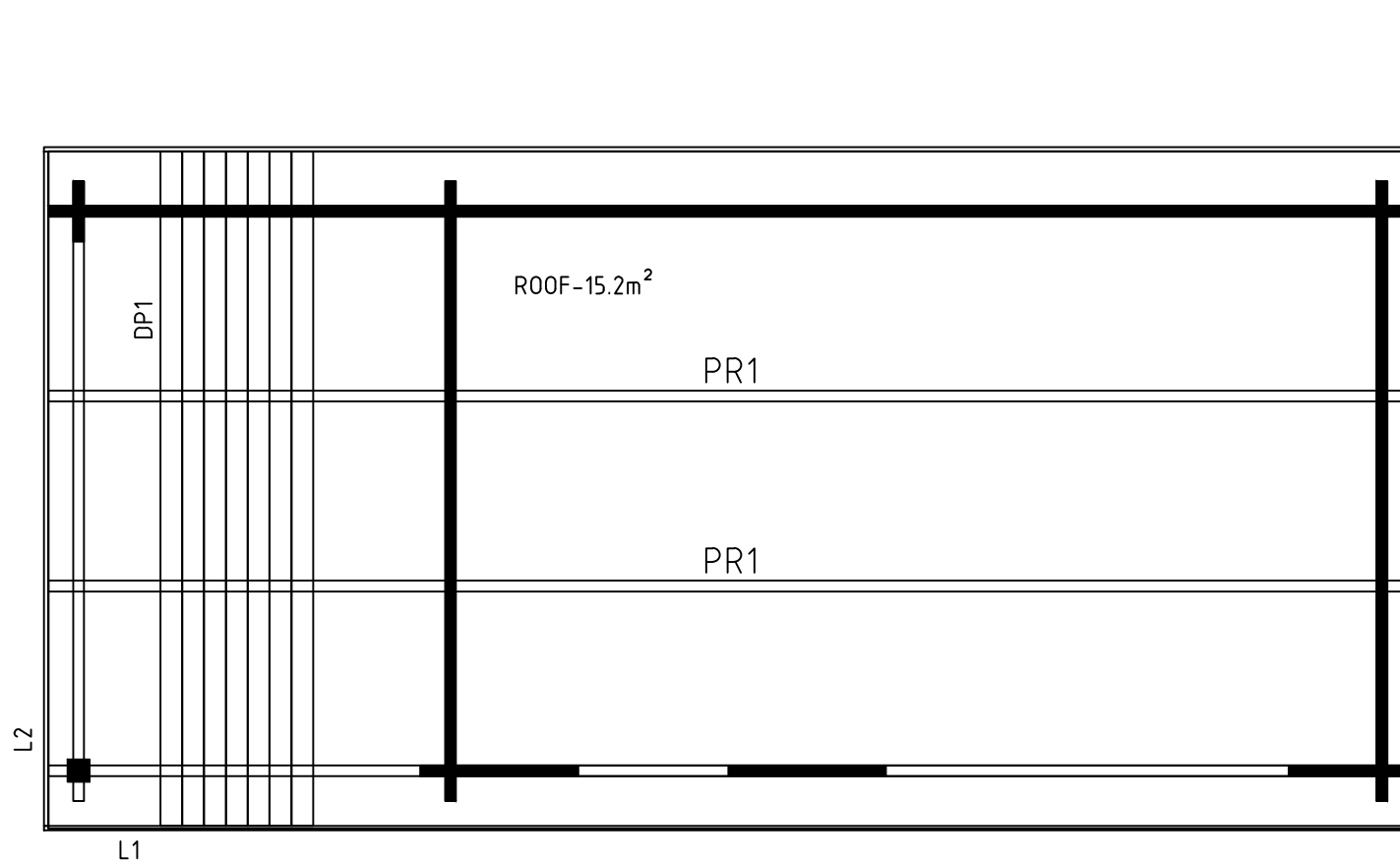

Model	MariaRondo44C ISO	Drawing	ROOF	Page		
 www.gartenhaus-gmbh.de www.gartenhaus.at www.gartenhaus.ch +49 (0) 40 537 9978-50	Drawn by	R.Tamm	Material	44x135	Scale	1:30
	Date	29.03.2017	File	MariaRondo44C.dwg		

The guide is illustrative. This guide is not project specification.
 Der Leitfaden ist illustrativ. Dieser Leitfaden ist keine Projektspezifikation.
 De gids is illustratief. Deze gids is geen projectspecificatie.

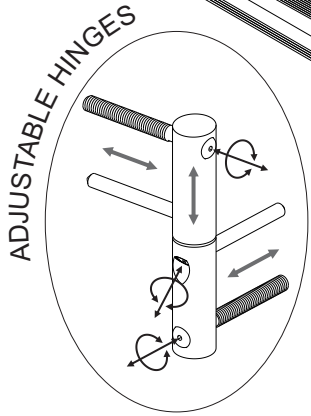
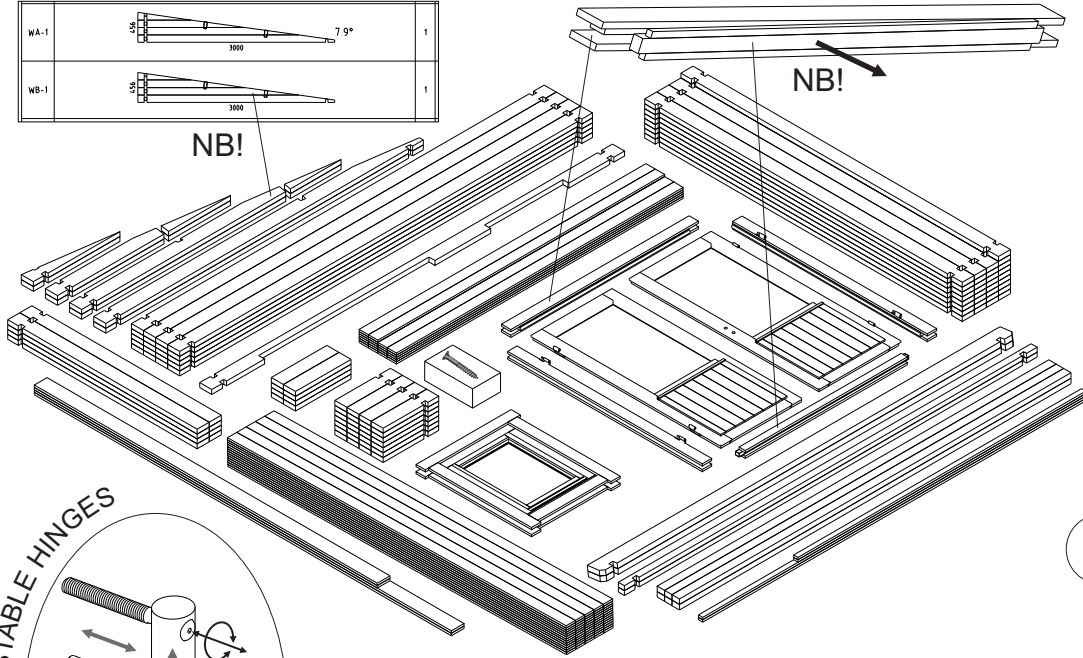
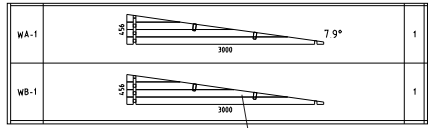

TYPE- B
4x60

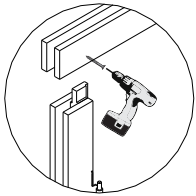

TYPE- B
4x60

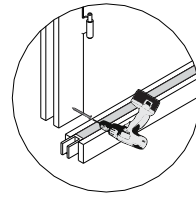

TYPE- A
5x90

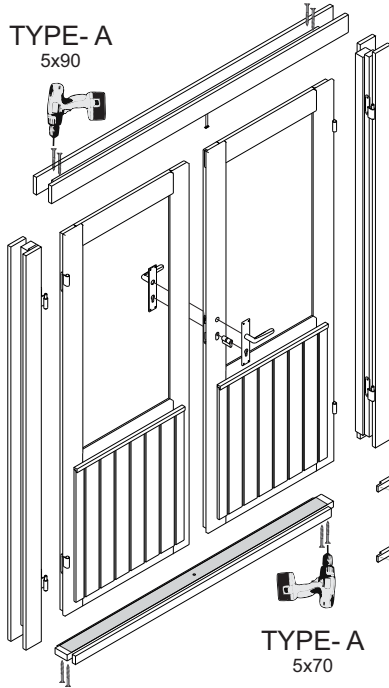

TYPE- A
5x70

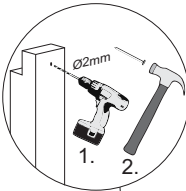

OPTIONS!

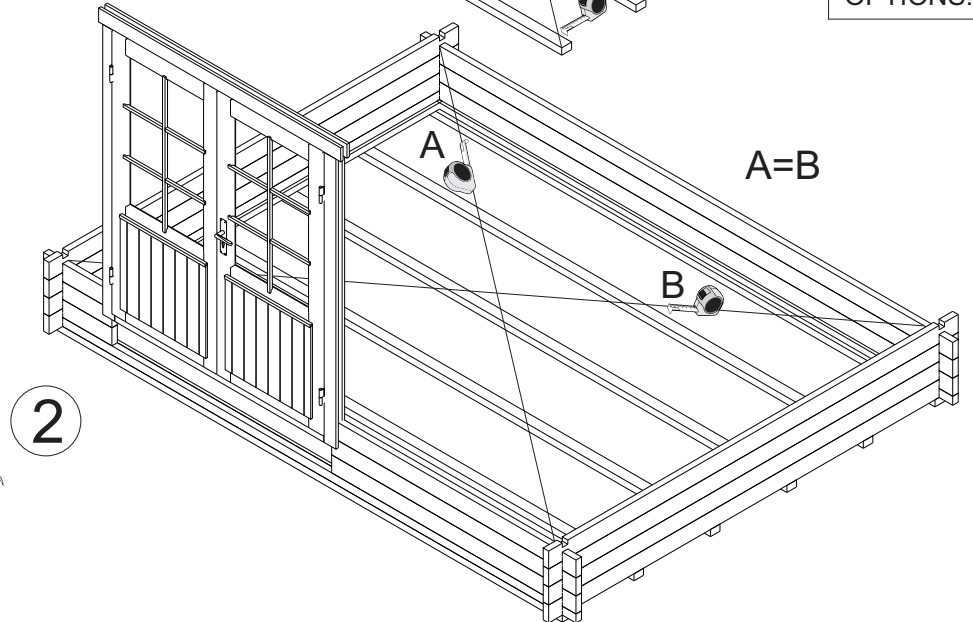
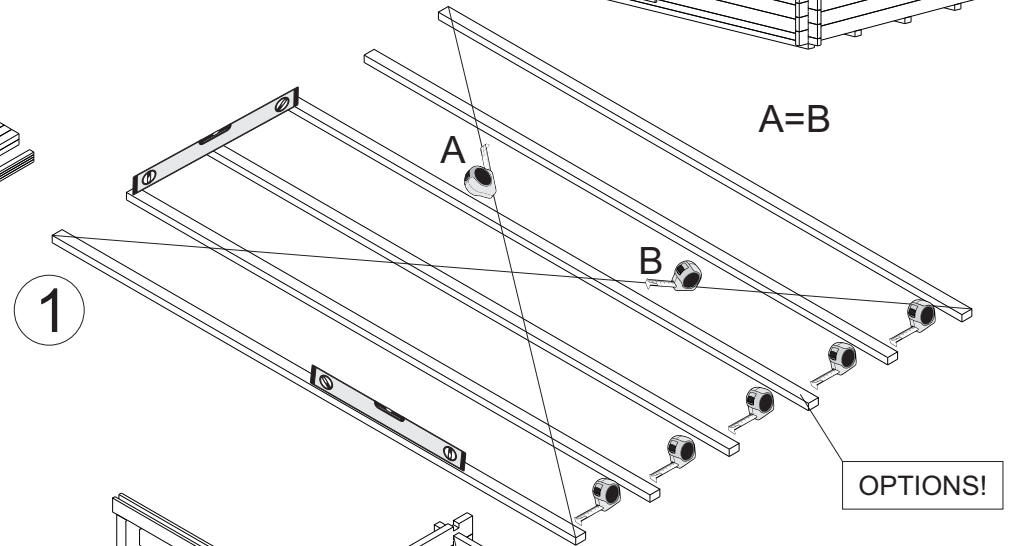
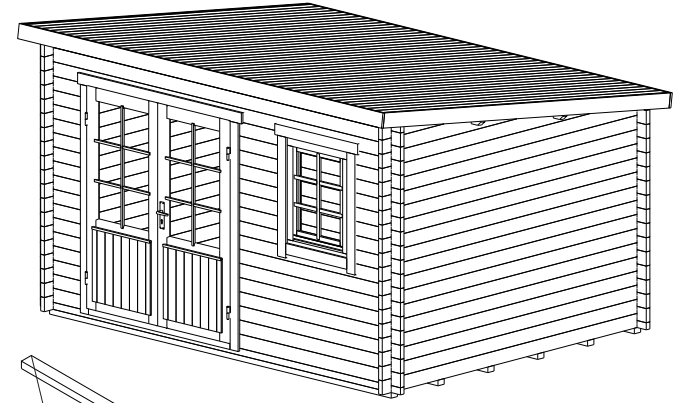
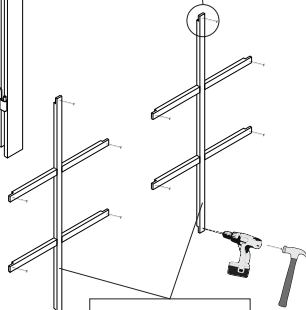

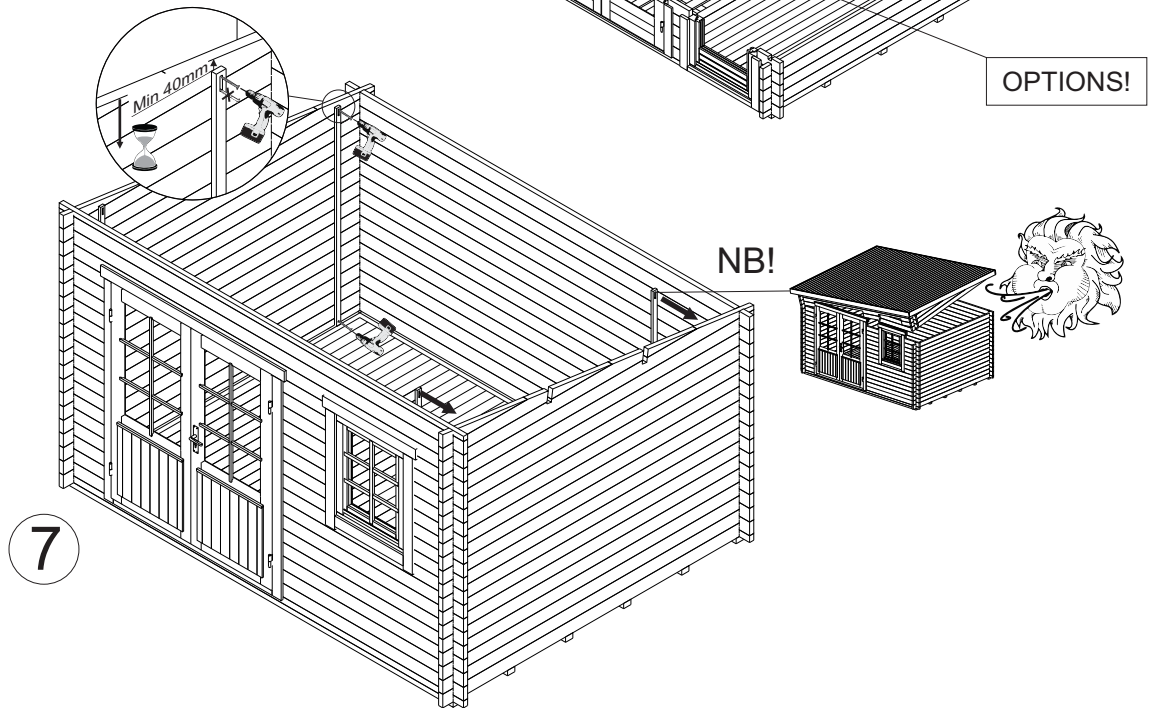
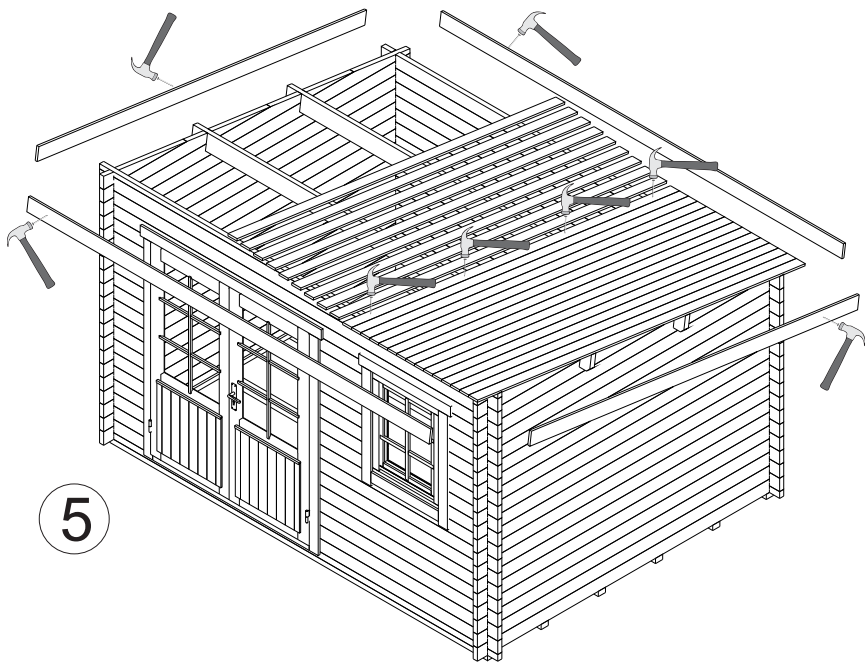
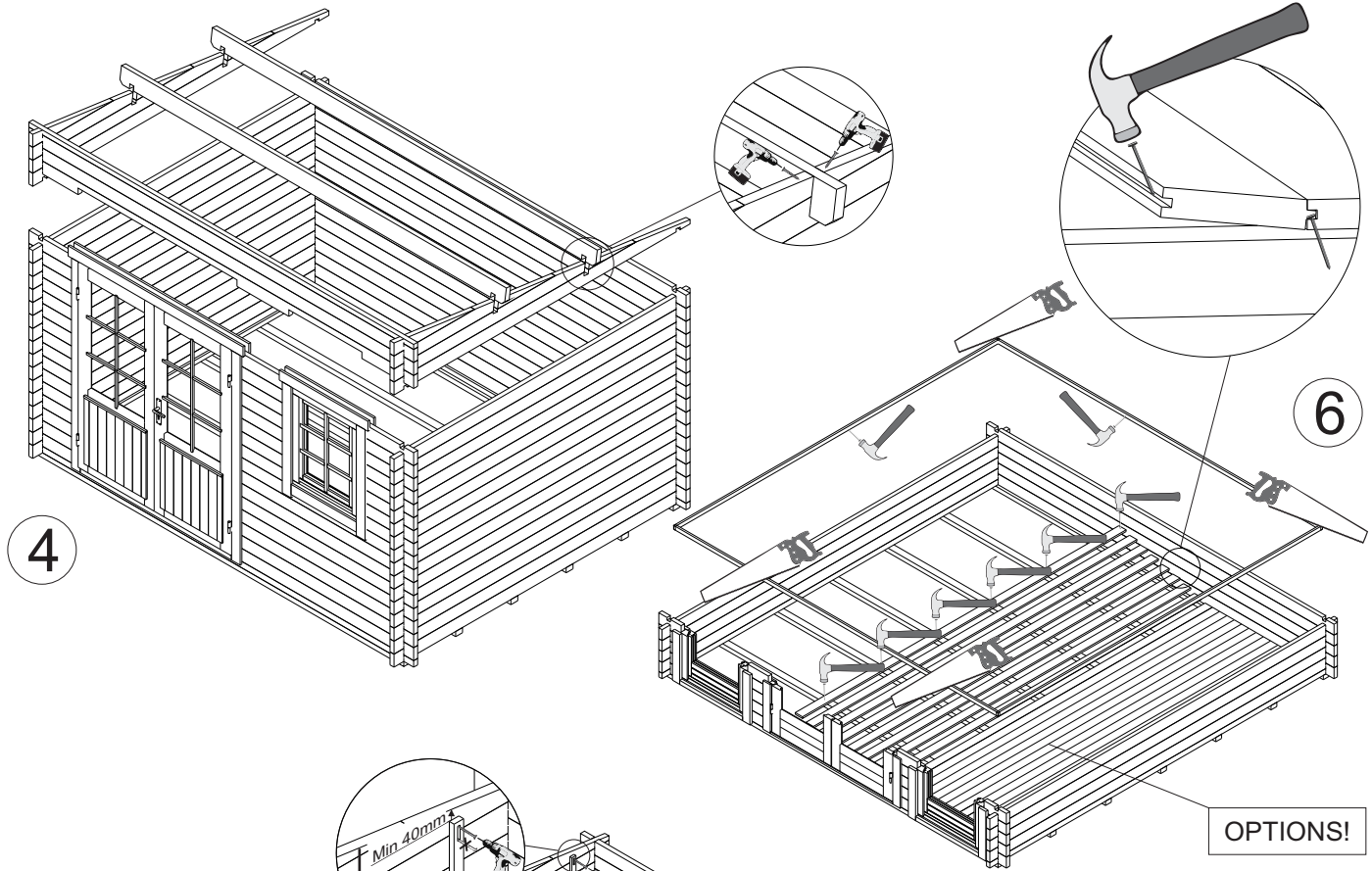
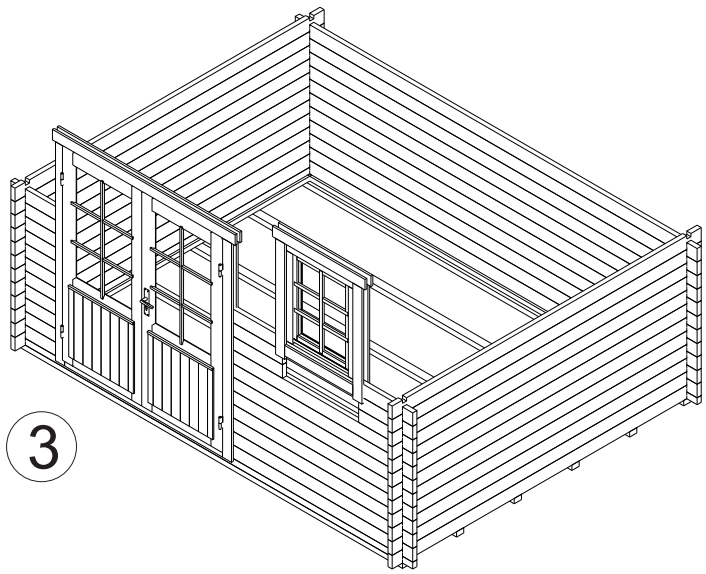

POST

