

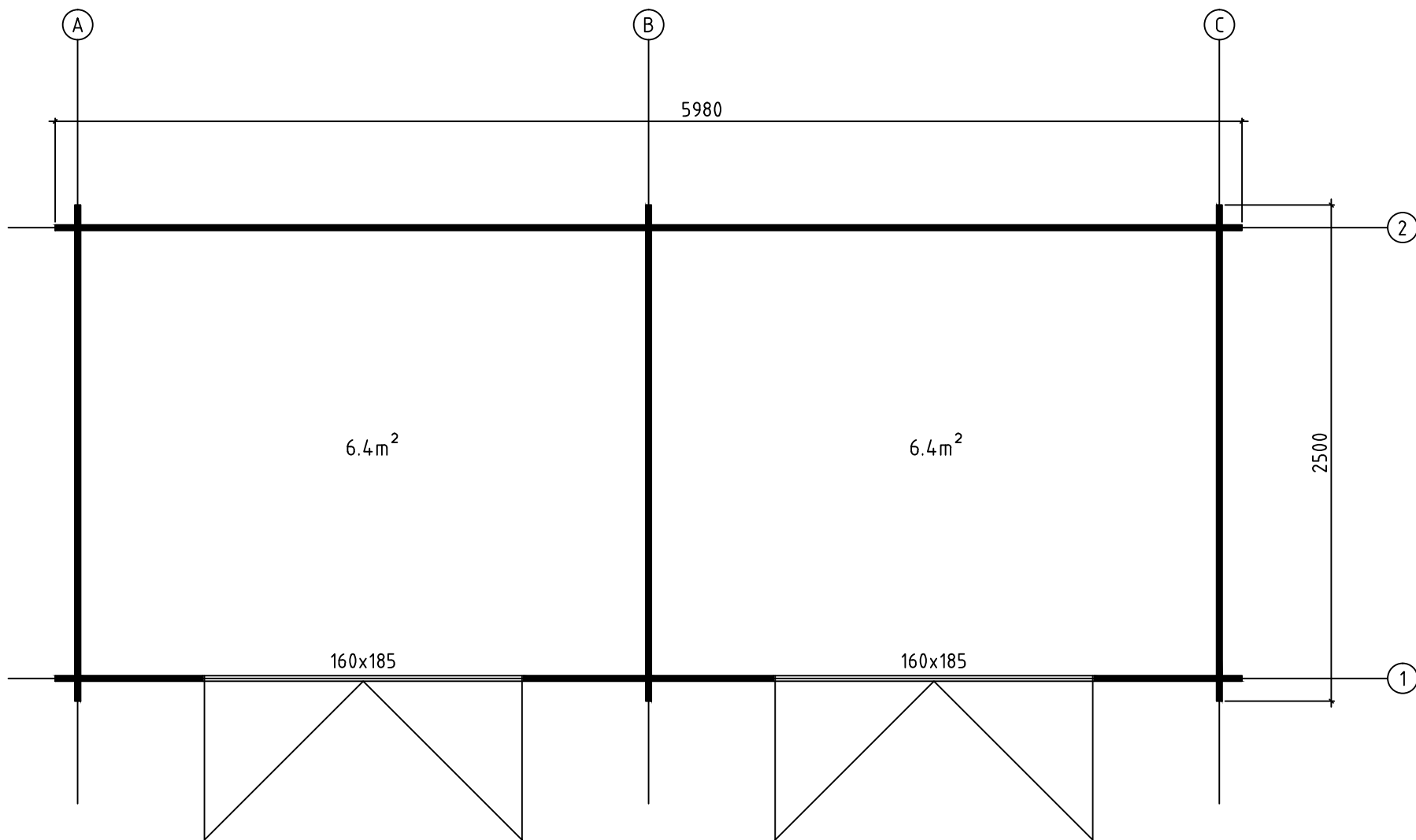



MariaTwin28





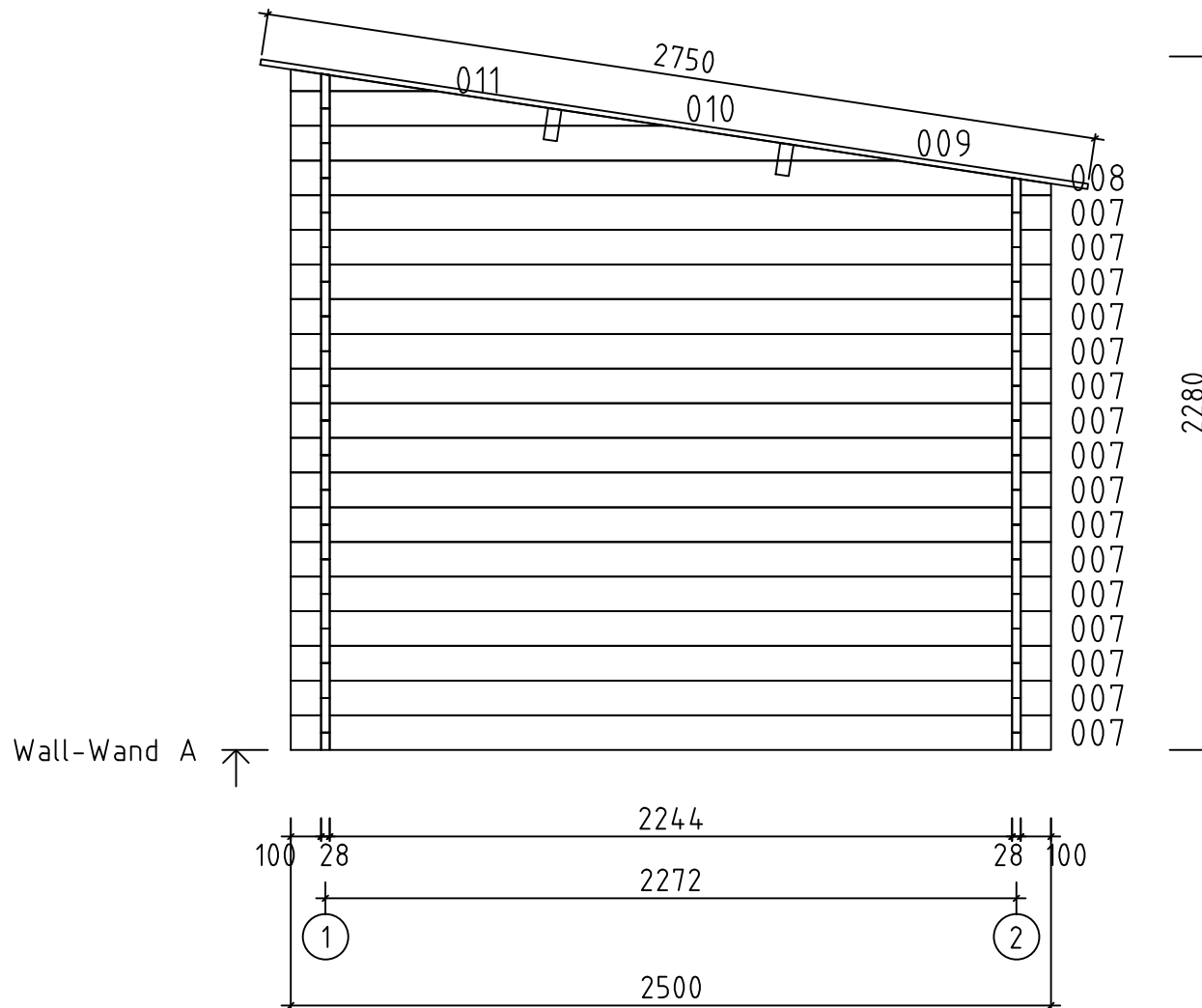



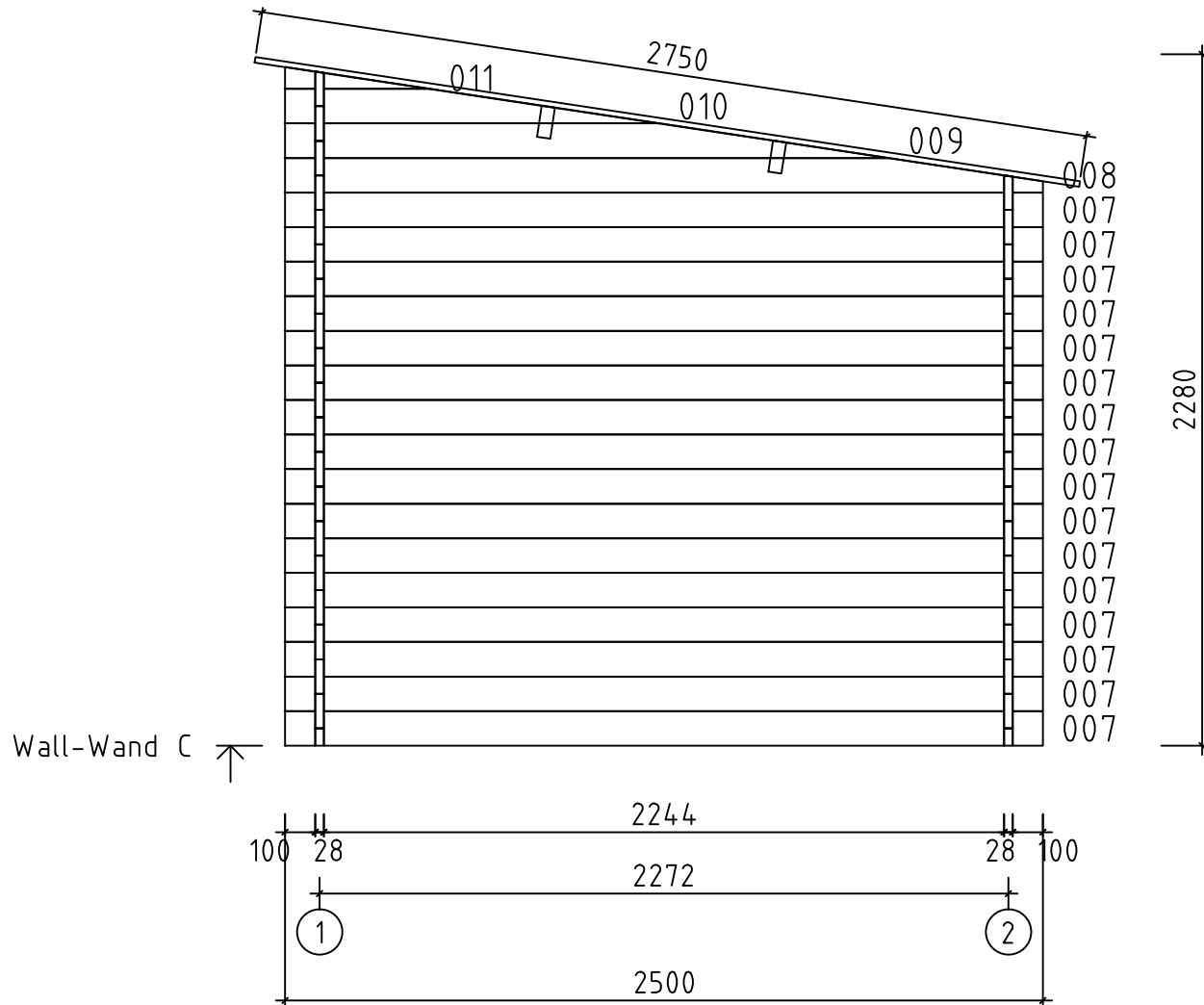

Model	MariaTwin28	Drawing	PLAN	Page
 www.gartenhaus-gmbh.de www.gartenhaus.at www.gartenhaus.ch +49 (0) 40 537 9978-50	Drawn by	R.Tamm	Material	28x114
	Date	27.04.2017	File	MariaTwin28.dwg
			Scale	1:30

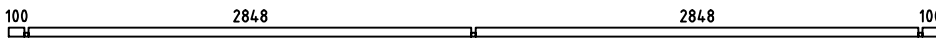
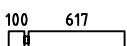
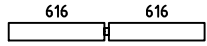
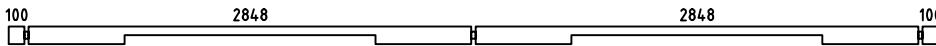

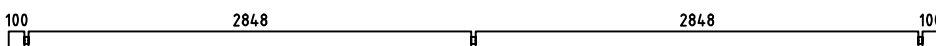
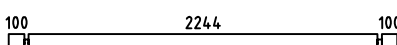
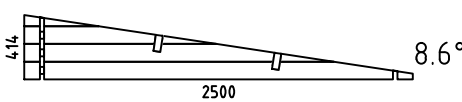
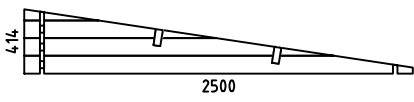
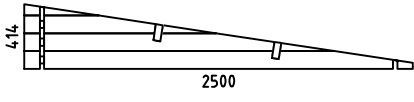
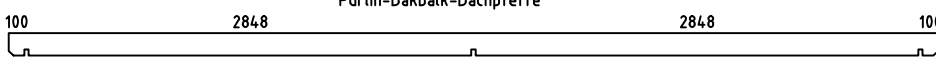
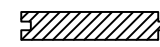
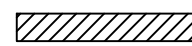

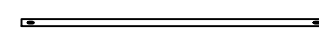
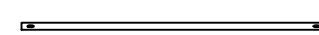
Model	MariaTwin28	Drawing	WALL-WAND A	Page	2	
 www.gartenhaus-gmbh.de www.gartenhaus.at www.gartenhaus.ch +49 (0) 40 537 9978-50	Drawn by	R.Tamm	Material	2.8x11.4	Scale	1:30
	Date	27.04.2017	File	MariaTwin28.dwg		

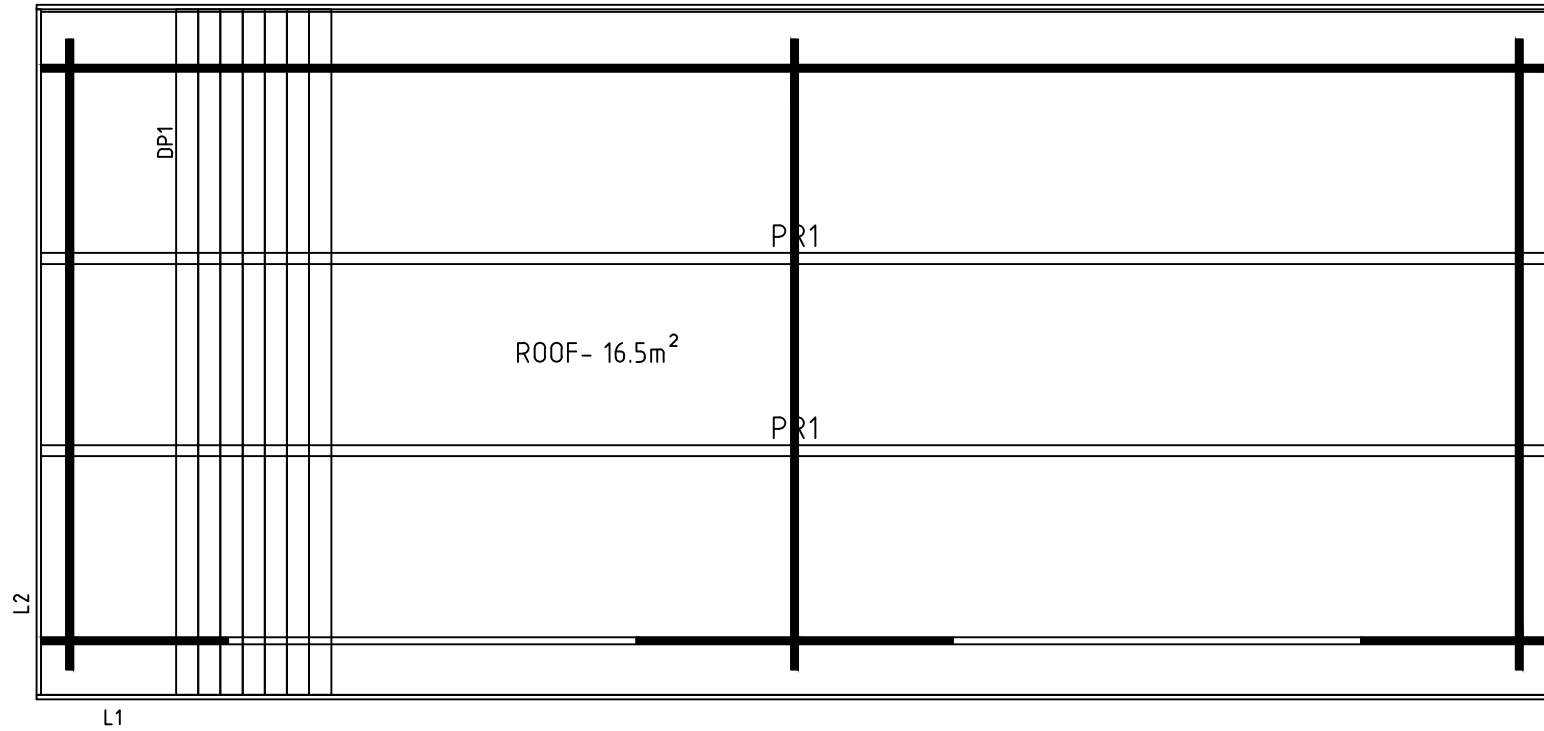

Model	MariaTwin28		Drawing	WALL-WAND C		Page	4
 www.gartenhaus-gmbh.de www.gartenhaus.at www.gartenhaus.ch +49 (0) 40 537 9978-50	Drawn by	R.Tamm	Material	2.8x11.4		Scale	1:30
	Date	27.04.2017		File	MariaTwin28.dwg		

Pos	Specification-Spezifikation-Specificatie MariaTwin28	St.	Profile (mm)	Length (mm)
001		2	28x57	5980
002		32	28x114	745
003		16	28x114	1260
004		1	28x114	5980
005		16	28x114	5980
006		2	28x114	5980
007		48	28x114	2500
WA-1		1		
WB-1		1		
WC-1		1		
PR1		2	44x144	5980
DP1	Roof board-Dachbrett-Dakplank 	68	88x18	2750
L2	Eave Board-Traufenblende-Afdekplank 	2	18x120	2790
L1	Facia Board-Giebelblende-Gevelplank 	4	18x120	3008
	Storm Brace-Sturmleiste 	2	18x40	1820
	Storm Brace-Sturmleiste 	2	18x40	2000
	Double Door Set-Doppeltür Satz-Dubbele Deur Set  3x25	2		
	Nail-Nagel-Spijker 	300		
	Ventilation Panel-Lüftungsgitter Set 	1		
	Wood Bolt set for Storm Brace-Holzschraubensatz für Sturmleisten 6x45 	8		
Kood	GartenHaus GmbH	Materjal	File MariaTwin28.dwg	Leht 1/2



Model	MariaTwin28	Drawing	ROOF	Page
 www.gartenhaus-gmbh.de www.gartenhaus.at www.gartenhaus.ch +49 (0) 40 537 9978-50	Drawn by	R.Tamm	Material	28x114
	Date	27.04.2017	File	MariaTwin28.dwg
			Scale	1:30