

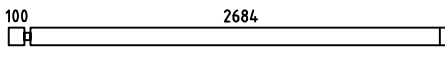

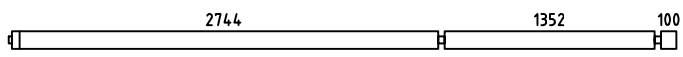

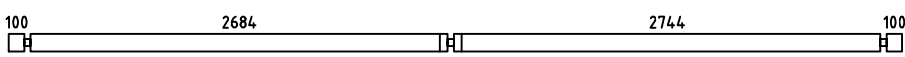

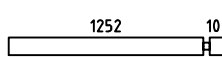

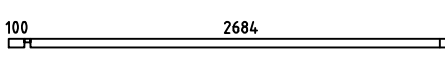
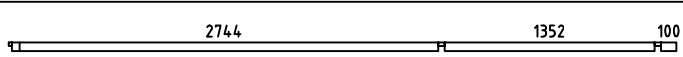
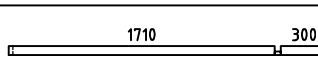

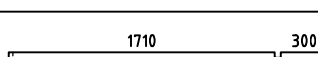

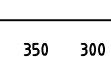
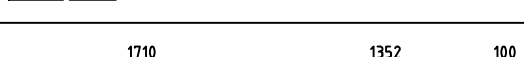
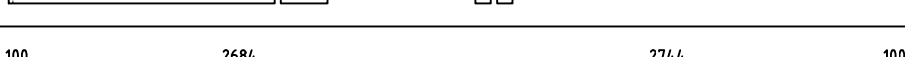
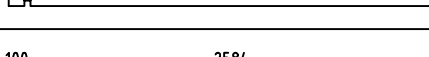
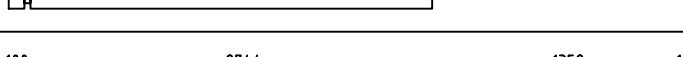
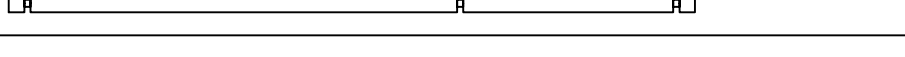
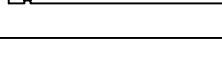
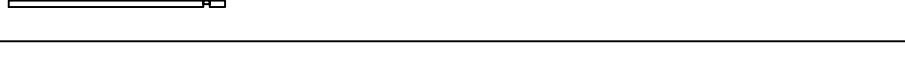
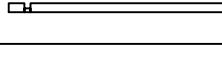
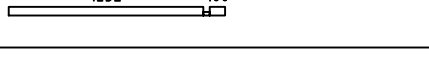
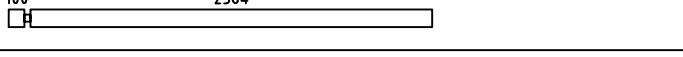

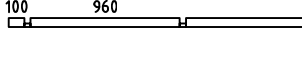
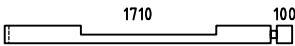
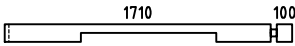
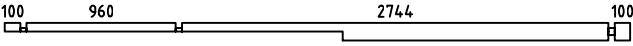
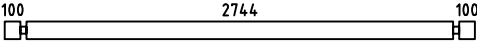
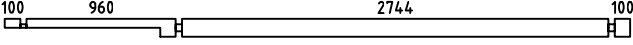
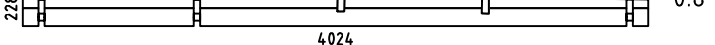
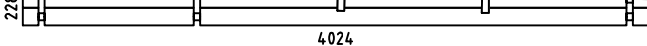
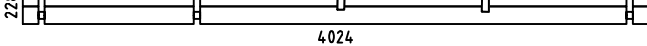
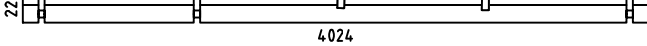
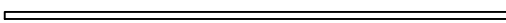



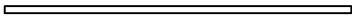
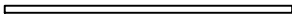
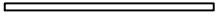
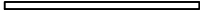

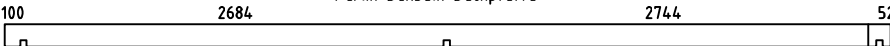
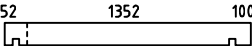
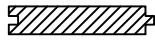

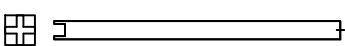

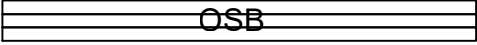

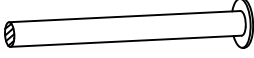
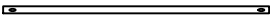



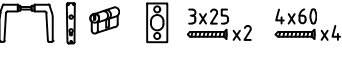
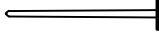



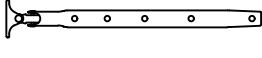

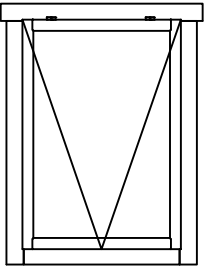
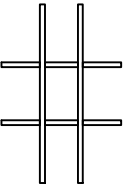

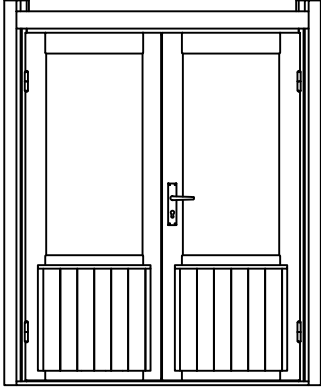
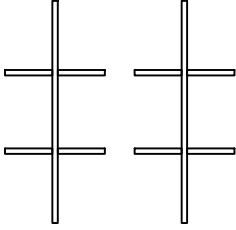
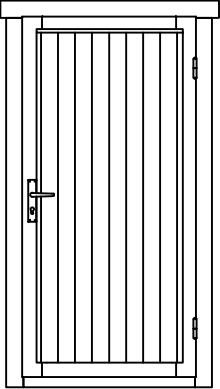
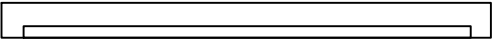
Johanna40 Plus

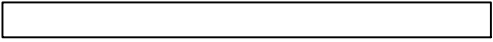
Chelsea40 Plus

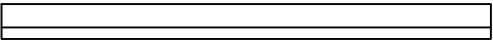
Pos	Specification-Spezifikation-Specificatie Johanna40 Plus_Chelsea40 Plus	St.	Profile (mm)	Length (mm)
001		1	40x114	2844
002		1	40x114	4296
003		1	40x114	5748
004		11	40x114	1392
005		1	40x56	2844
006		1	40x56	4296
007		1	40x57	2050
008		1	40x57	240
009		5	40x114	2050
010		16	40x114	240
011		21	40x114	490
012		11	40x114	690
013		1	40x114	3242
014		10	40x114	5748
015		10	40x114	2724
016		10	40x114	4416
017		1	40x41	5748
018		1	40x41	1392
019		1	40x57	5748
020		1	40x57	1392
021		1	40x114	2724
022		1	40x114	4416
023		27	40x114	490
024		1	40x114	4024
027		5	40x114	1850

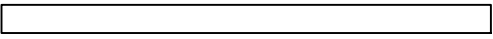
Pos	Specification-Spezifikation-Specificatie Johanna40 Plus_Chelsea40 Plus	St.	Profile (mm)	Length (mm)
028		1	40x114	1850
029		1	40x114	1850
030		1	40x114	4024
032		34	40x114	3024
033		2	40x114	4024
WA-1		1		
WB-1		1		
WC-1		1		
WD-1		1		
FB8	FOUNDATION BEAM-FUND.BALKEN-FUND.BALK 	1	70x45	3242
FB3	FOUNDATION BEAM-FUND.BALKEN-FUND.BALK 	1	70x45	2738
FB2	FOUNDATION BEAM-FUND.BALKEN-FUND.BALK 	3	70x45	2730
FB4	FOUNDATION BEAM-FUND.BALKEN-FUND.BALK 	4	70x45	2660
FB6	FOUNDATION BEAM-FUND.BALKEN-FUND.BALK 	1	70x45	2230
FB1	FOUNDATION BEAM-FUND.BALKEN-FUND.BALK 	1	70x45	1850
FB7	FOUNDATION BEAM-FUND.BALKEN-FUND.BALK 	1	70x45	1400
FB5	FOUNDATION BEAM-FUND.BALKEN-FUND.BALK 	5	70x45	1252
CS1	CORNICE SUPPORT-TRAGELEISTE FÜR GESIMSE-KROONLIJST STEUNEN BAR 	5	44x70	100
PR1	Purlin-Dakbalk-Dachpfette 	2	44x14.4	5700
PR2	Purlin-Dakbalk-Dachpfette 	2	44x14.4	1584
VB-1	Floor board-Fussbodenbrett-Vloerplank 	42	88x18	2734
VB-2	Floor board-Fussbodenbrett-Vloerplank 	6	88x18	2434
DP-1	Roof board-Dachbrett-Dakplank 	82	88x18	4024
	+POST 85x85 	3		2040
	Base Board-Fussbleiste-Plinten 18x40x3000 	7	18x40	21 rmt.

Pos	Specification-Spezifikation-Specificatie Johanna40 Plus_Chelsea40 Plus	St.	Profile (mm)	Length (mm)
L-1	Cornice-Gesimse-Kroonlijst 	2	20x250	2865
L-2	Cornice-Gesimse-Kroonlijst 	2	20x250	4040
L-3	Cornice-Gesimse-Kroonlijst 	2	20x250	4315
SBH-1	Steel bar H-Stahlstange-Stalen staaf Ø14 	2		260
	Storm Brace-Sturmleiste 	4	18x40	2000
	Adjustable foot-Stellfuß+Schrauben 5x40 4stück für Post 	3		
PE1	Ceiling Element-Deckenelement-Plafond Element 1 	1	931x1316	
	Door Set-Tür Satz-Deur Set 	1		
	Double Door Set-Doppeltür Satz-Dubbele Deur Set  3x25 x2 4x60 x4	1		
	Nail-Nagel-Spijker 	770	1.8x40	
	Nail-Nagel-Spijker 1.6x30 	35	1.6x30	
	Screw-Schraube-Schroef 5x90 	10		
	Screw-Schraube-Schroef 6x120 	30		
	Ventilation Panel-Lüftungsgitter Set 	1		
WS1	Window Stay-Fensterfeststelle 	2		
	Wood Bolt set for Storm Brace-Holzschraubensatz für Sturmleisten  6x45	8		
W9N 86.5 x122.5	WINDOW 865x1225  Window Glazing Bar Fenstersprossen Raamroeden 	2		
Kood	Johanna40 Plus_Chelsea40 Plus	File	Johanna40 Plus_Chelsea40 Plus.dwg	3/4

Pos	Specification-Spezifikation-Specificatie Johanna40 Plus_Chelsea40 Plus			St.	Profile (mm)	Length (mm)
DD6P 14.15 x189.1	DOOR 1415x1891  Door Glazing Bar Türsprossen Deurroeden 			1		
SDL 94.5 X190 R	DOOR 945x1900 			1		
CORNER DOOR SET						
1	Top Jamb			1	58x42	1415
2	Threshold			1	58x42	1415
3-4	Vertical Jamb			2	58x42	1781
5-6	Post Set			1+1	42x61	2020
7-8	Cover Slat			2	40x18	1860
9-10	Casting			2	18x95	1500
	Screw-Schraube-Schroef 4x60			16		
	Screw-Schraube-Schroef 5x90			16		
Kood	Johanna40 Plus_Chelsea40 Plus	Material		File	Johanna40 Plus_Chelsea40 Plus.dwg	4/4

H = 1.700 m  
TOTAL: 24.63 m<sup>2</sup>

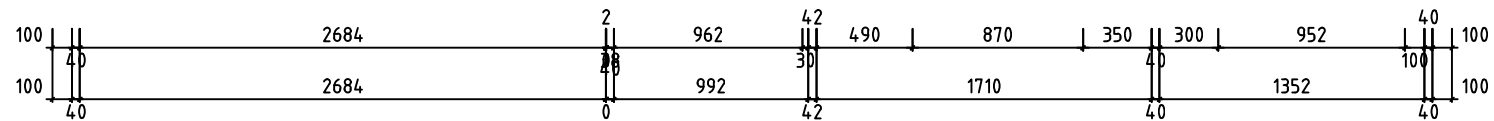
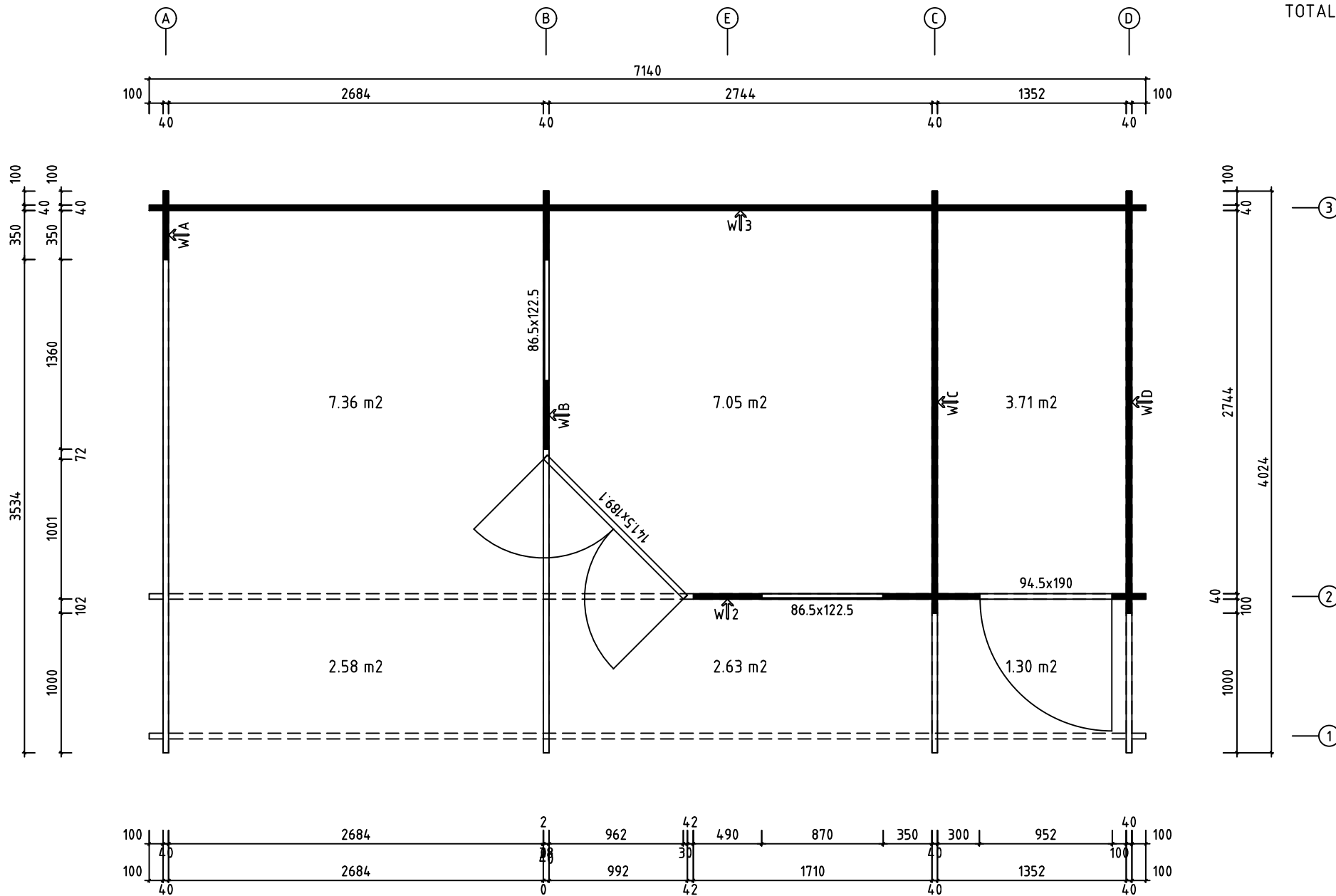

Model	Johanna40 Plus_Chelsea40 Plus	Page	PLAN
Drawn by	J.Soo	Material	40x114
Date	16.04.2020	File	Johanna40 Plus_Chelsea40 Plus.dwg
		Scale	1:30

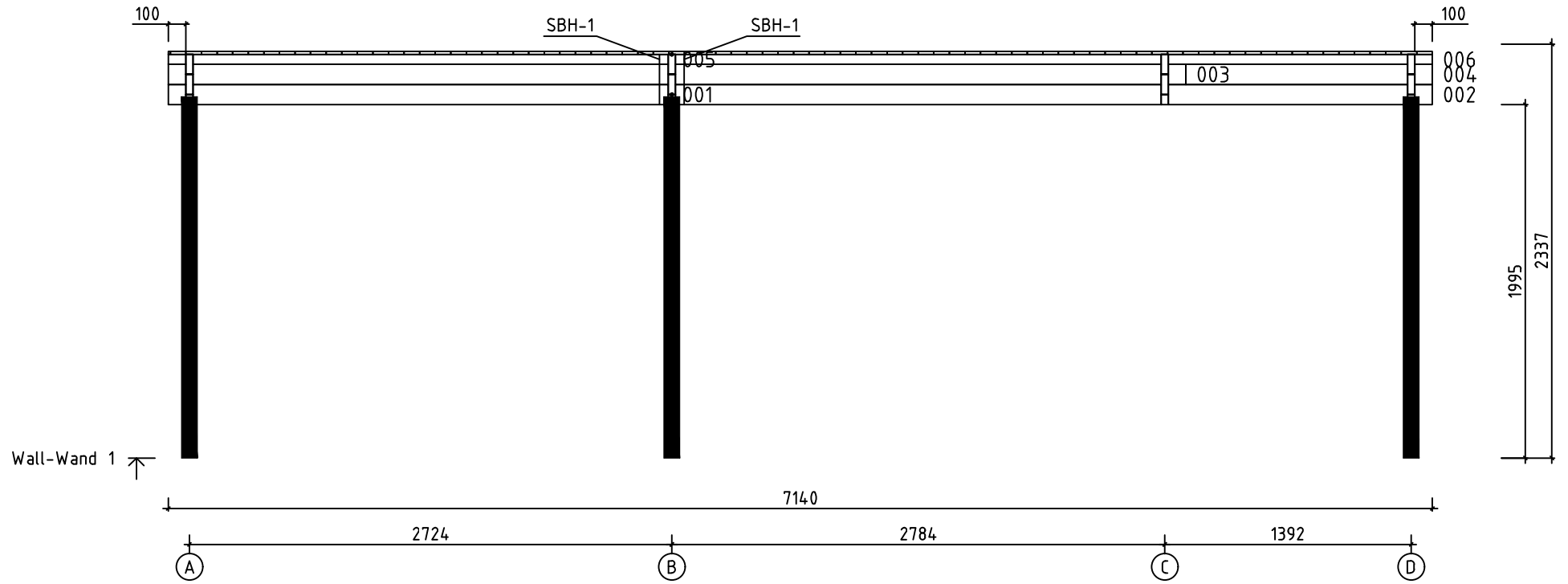

Model	Johanna40 Plus_Chelsea40 Plus	Page	9
Drawn by	J.Soo	Material	4x11.4
Date	16.04.2020	File	Johanna40 Plus_Chelsea40 Plus.dwg
		Scale	1:30

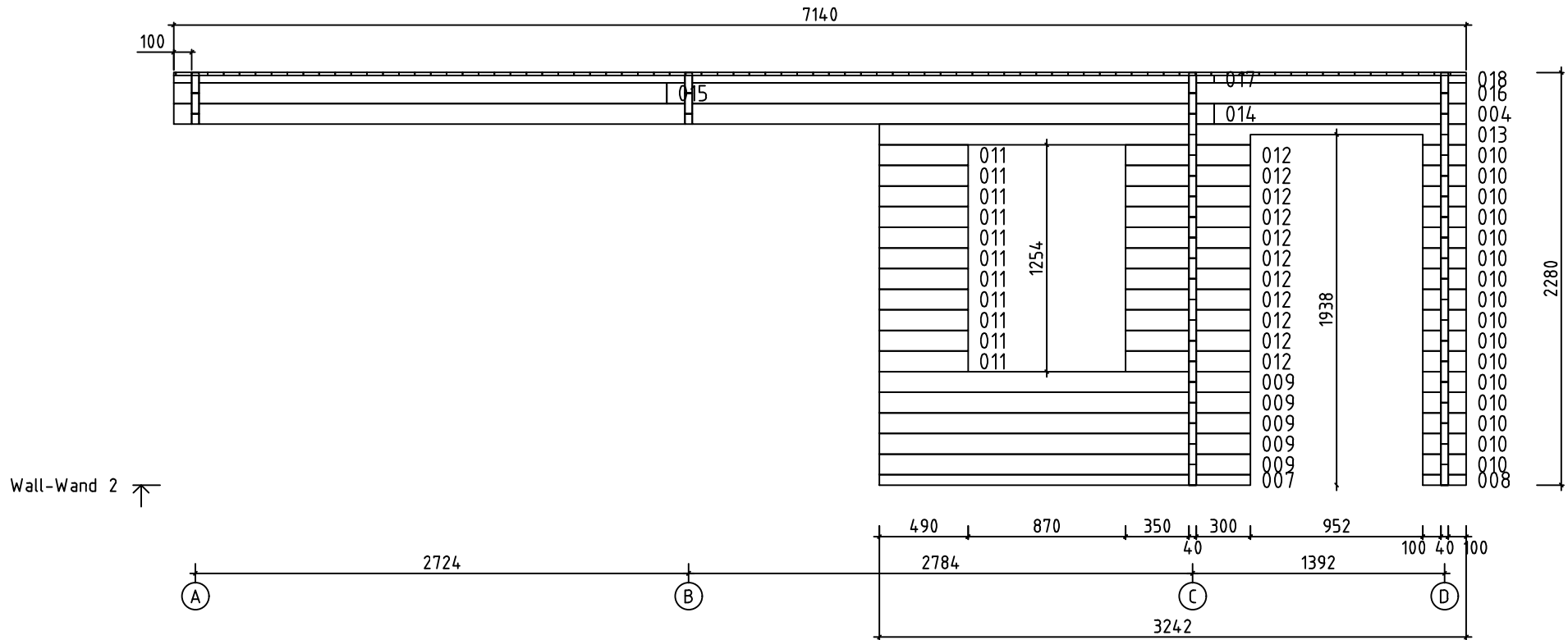

Model	Johanna40 Plus_Chelsea40 Plus	Page	10
Drawn by	J.Soo	Material	4x11.4
Date	16.04.2020	File	Johanna40 Plus_Chelsea40 Plus.dwg
		Scale	1:30



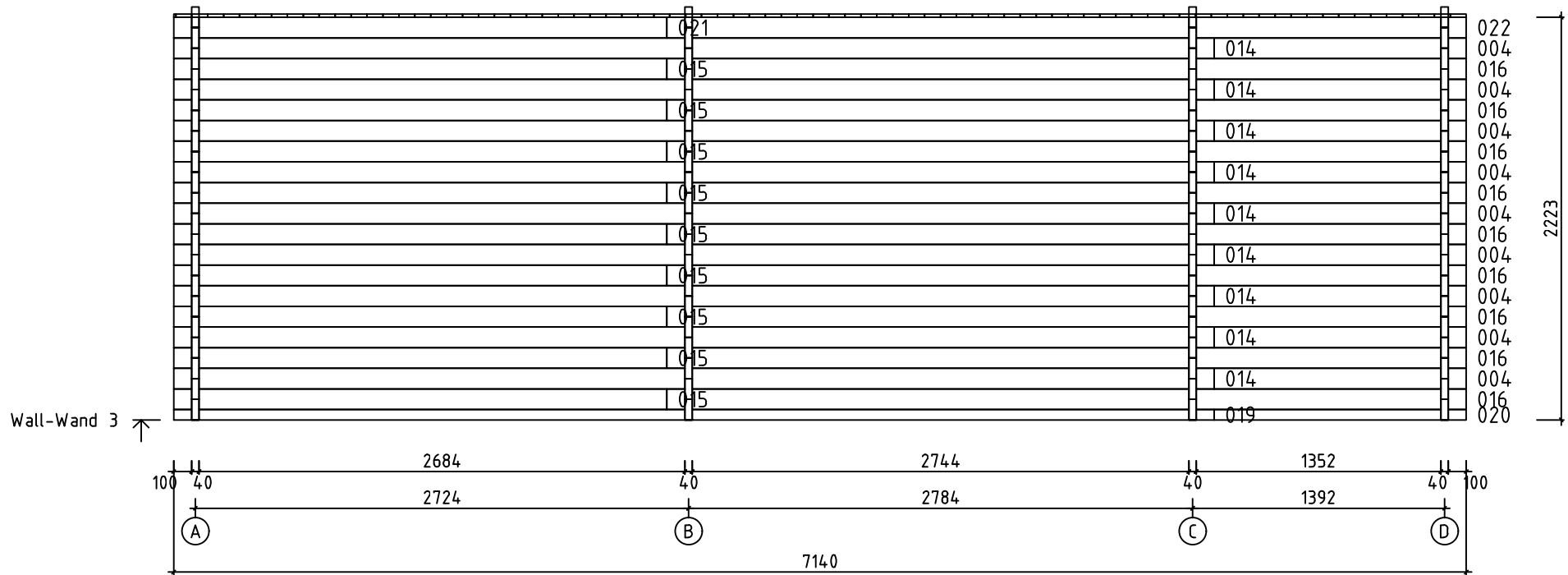

Model	Johanna40 Plus_Chelsea40 Plus		Page	11	
Drawn by	J.Soo	Material	4x11.4	Scale	1:30
Date	16.04.2020	File	Johanna40 Plus_Chelsea40 Plus.dwg		

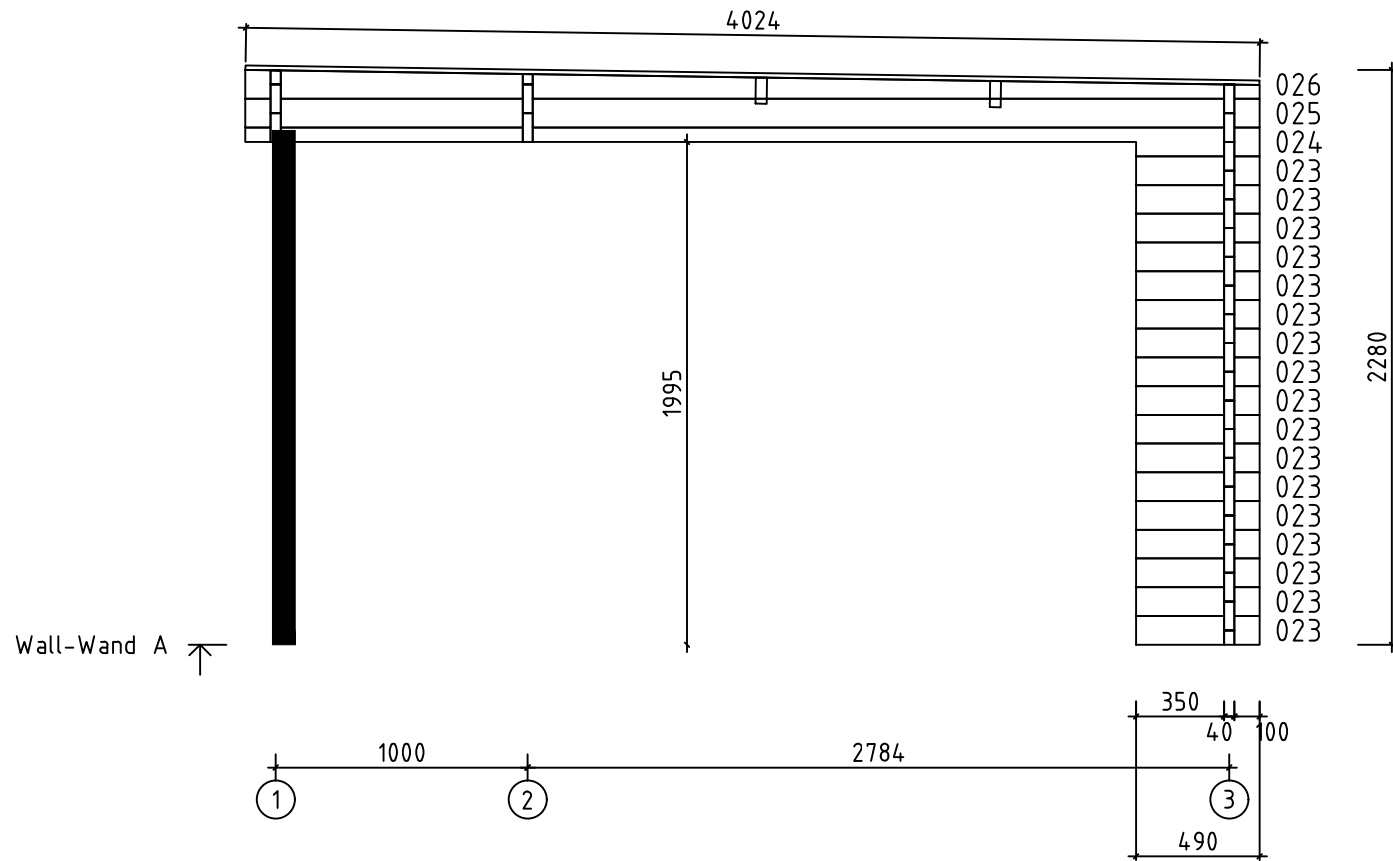

Model	Johanna40 Plus_Chelsea40 Plus	Page	4
Drawn by	J.Soo	Material	4x11.4
Date	16.04.2020	File	Johanna40 Plus_Chelsea40 Plus.dwg
		Scale	1:30

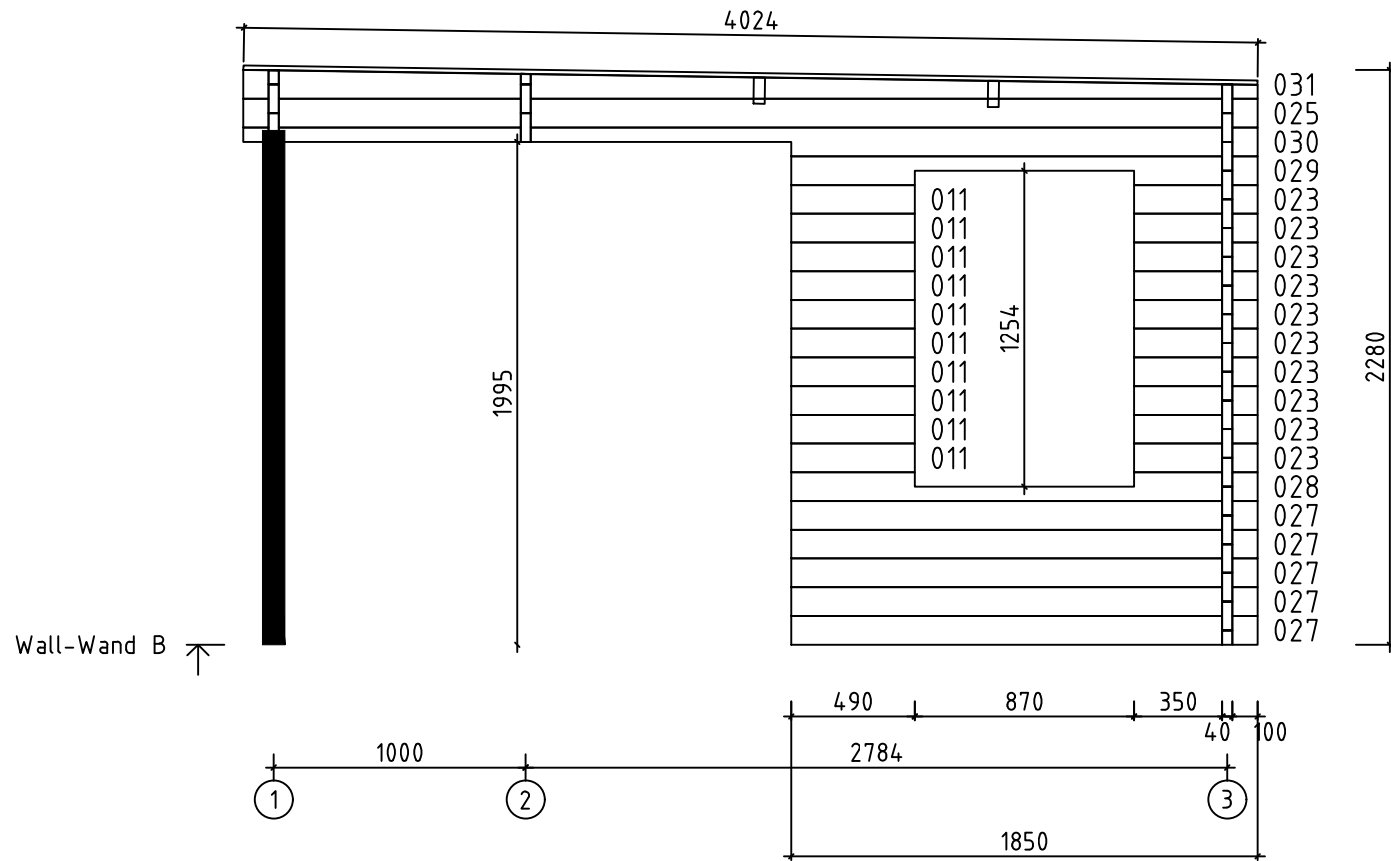

Model	Johanna40 Plus_Chelsea40 Plus	Page	5
Drawn by	J.Soo	Material	4x11.4
Date	16.04.2020	File	Johanna40 Plus_Chelsea40 Plus.dwg

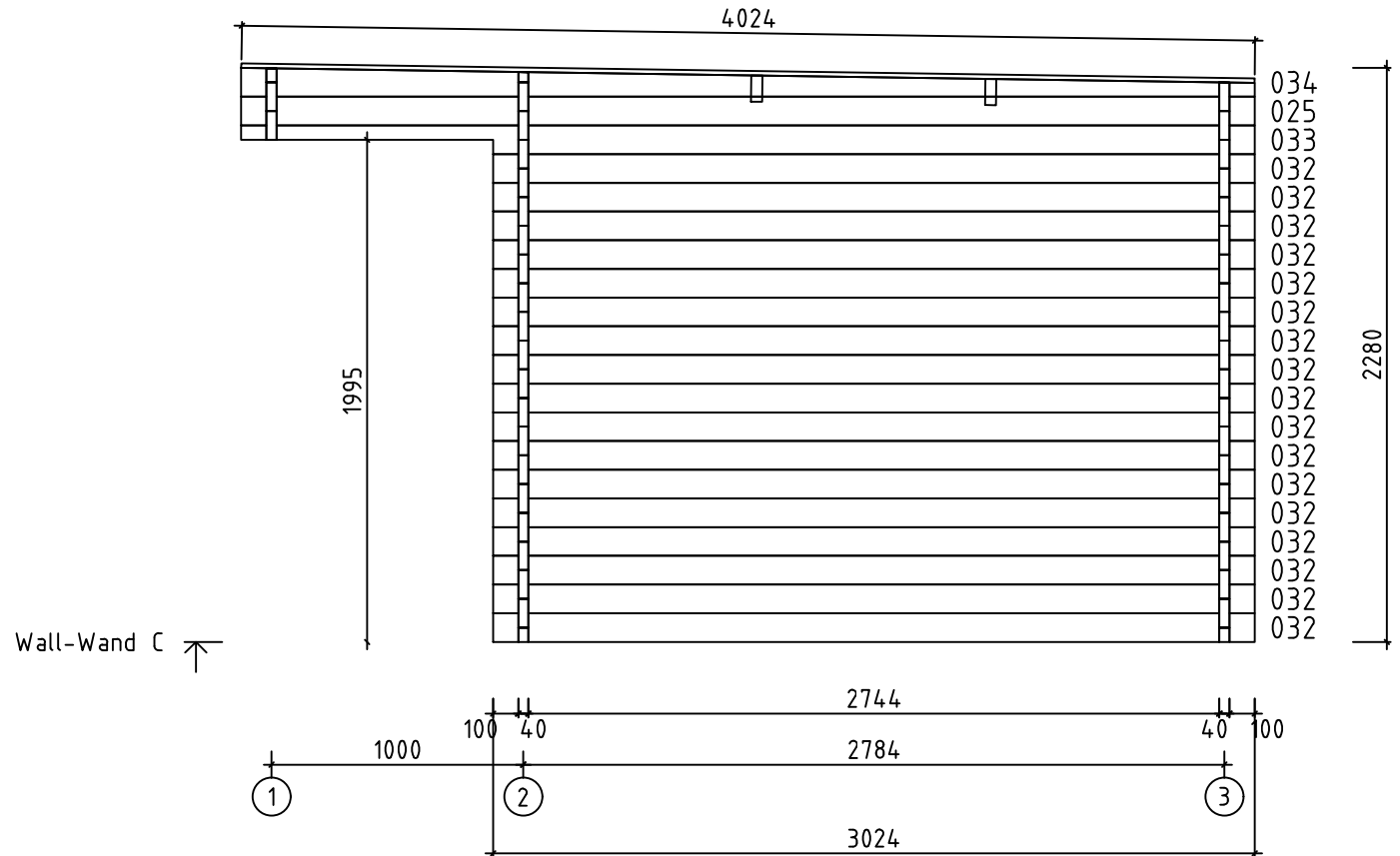

Model	Johanna40 Plus_Chelsea40 Plus	Page	6
Drawn by	J.Soo	Material	4x11.4
Date	16.04.2020	File	Johanna40 Plus_Chelsea40 Plus.dwg
		Scale	1:30

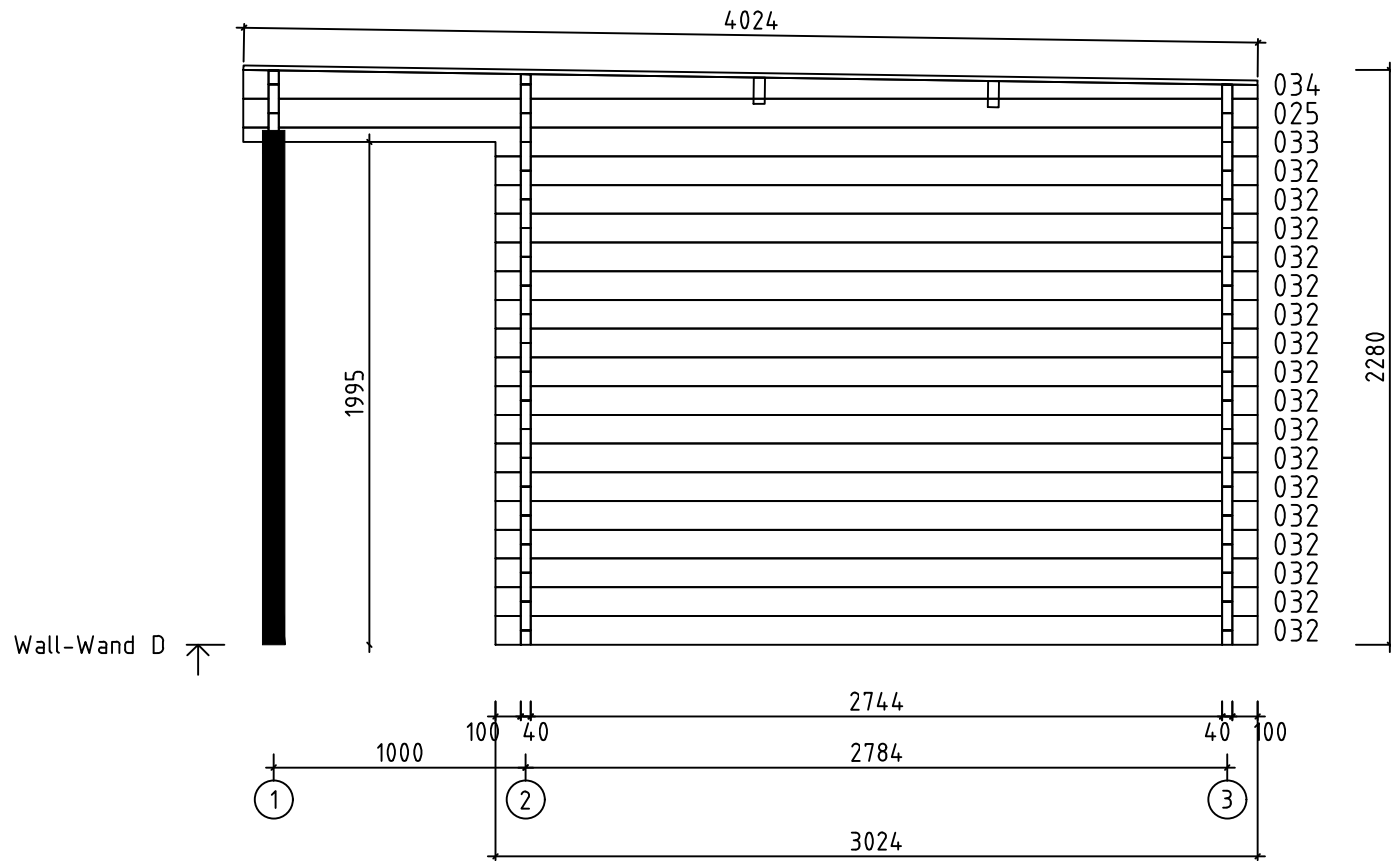

Model	Johanna40 Plus_Chelsea40 Plus	Page	7
Drawn by	J.Soo	Material	4x11.4
Date	16.04.2020	File	Johanna40 Plus_Chelsea40 Plus.dwg
		Scale	1:30

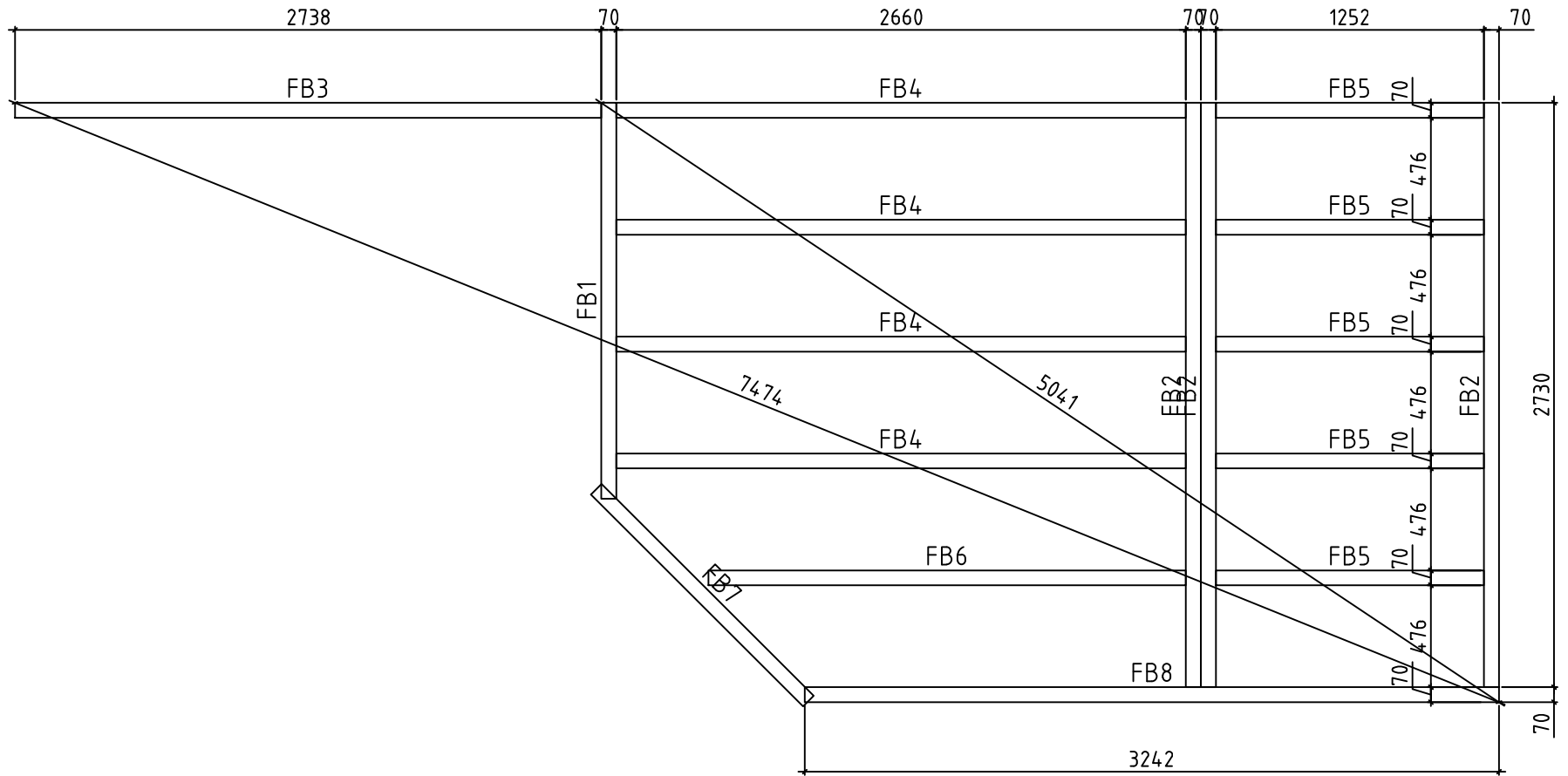

Model	Johanna40 Plus_Chelsea40 Plus	Page	FOUNDATION
Drawn by	J.Soo	Material	40x114
Date	16.04.2020	File	Johanna40 Plus_Chelsea40 Plus.dwg
		Scale	1:30

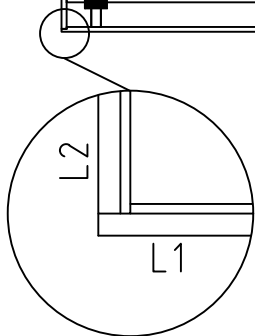
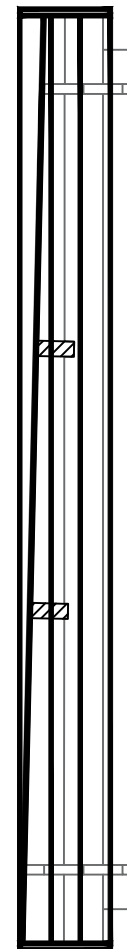
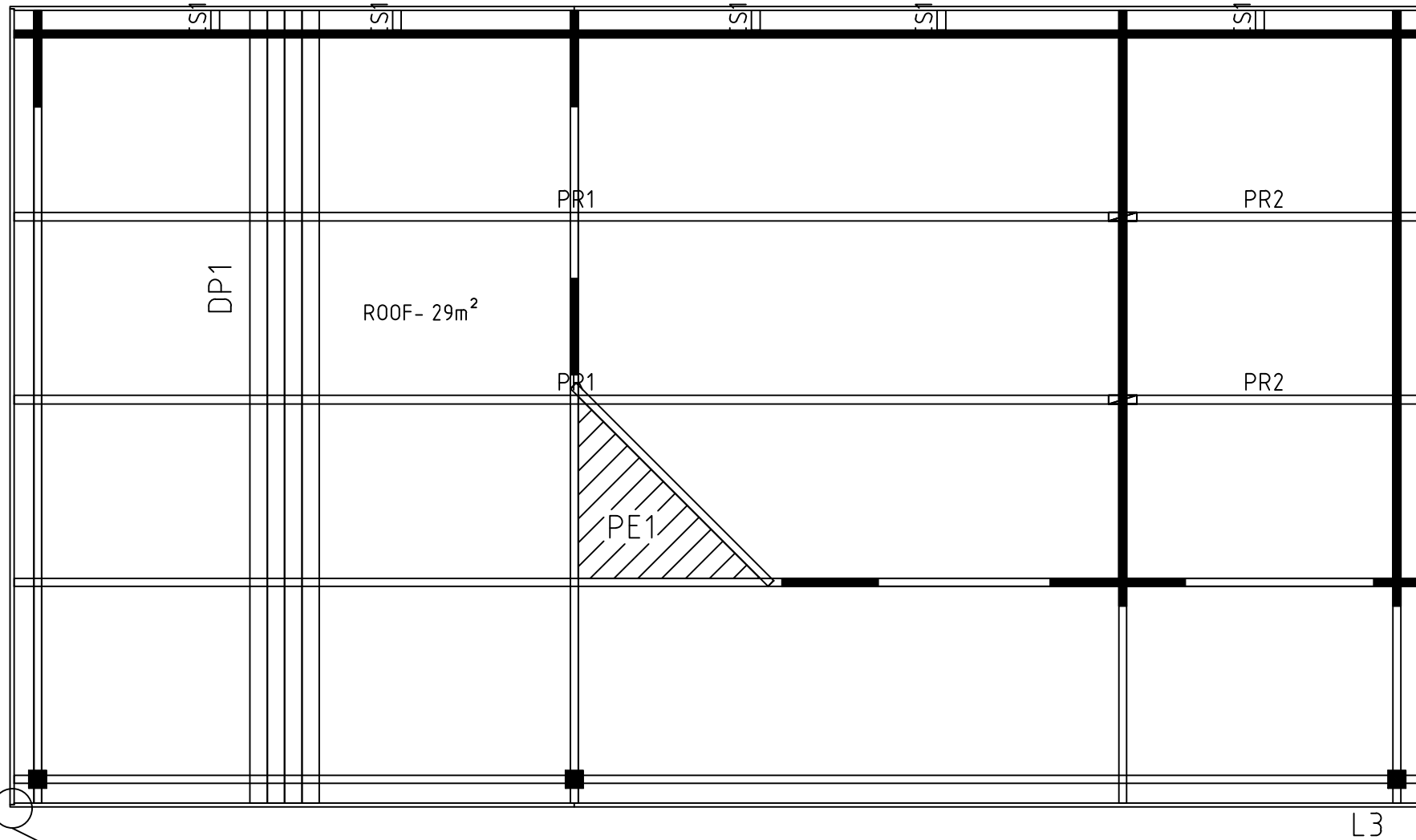

Model	Johanna40 Plus_Chelsea40 Plus	Page	ROOF
Drawn by	J.Soo	Material	40x114
Date	16.04.2020	File	Johanna40 Plus_Chelsea40 Plus.dwg
		Scale	1:30

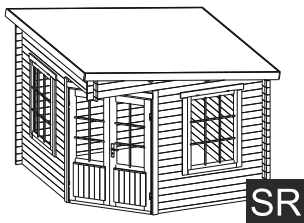
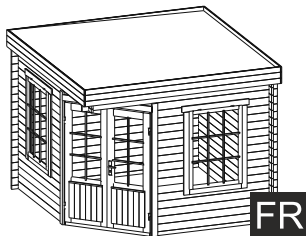

The guide is illustrative. This guide is not project specification.  
 Der Leitfaden ist illustrativ. Dieser Leitfaden ist keine Projektspezifikation.  
 De gids is illustratief. Deze gids is geen projectspecificatie.

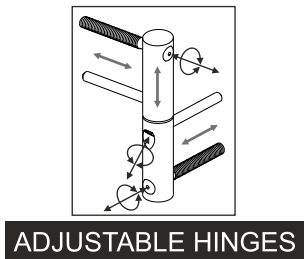
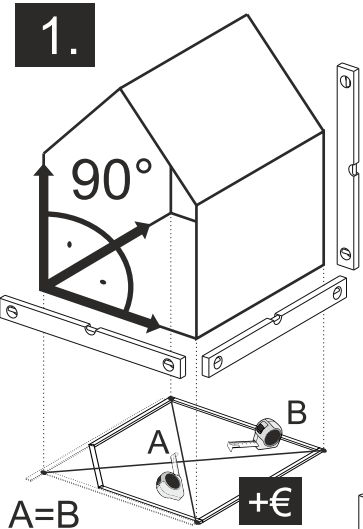
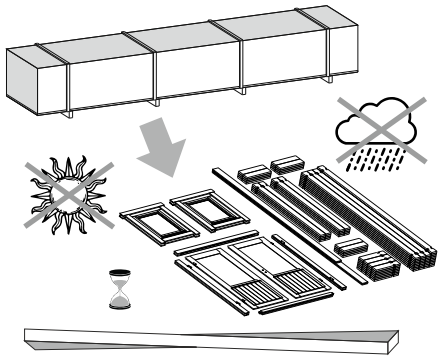

ADJUSTABLE HINGES

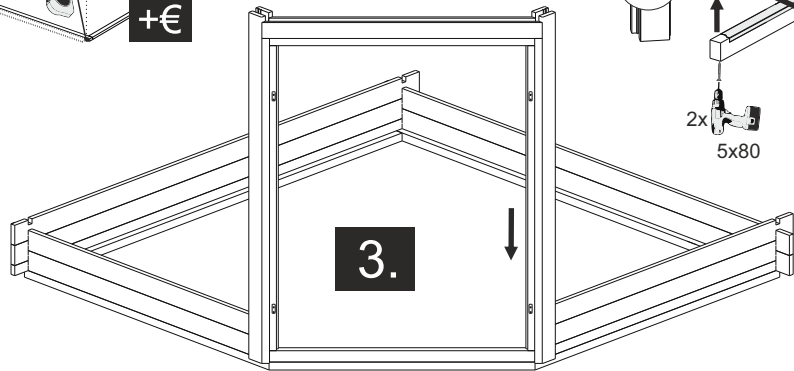

3.

2.

1.

DOOR INSTALL

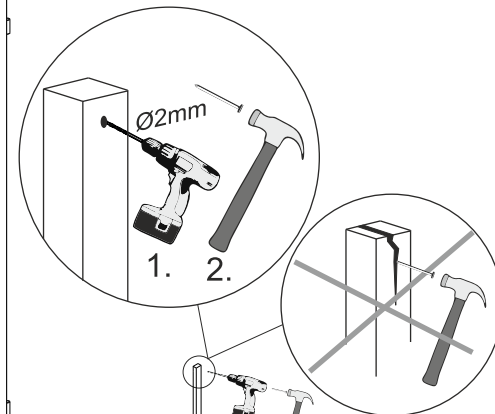
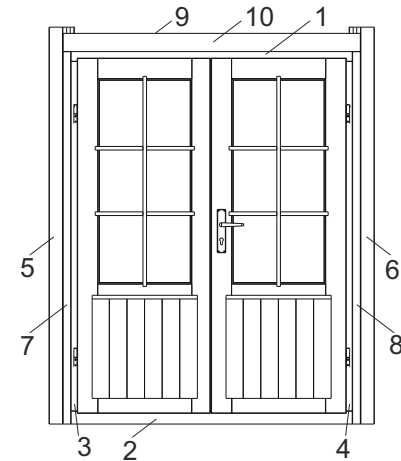
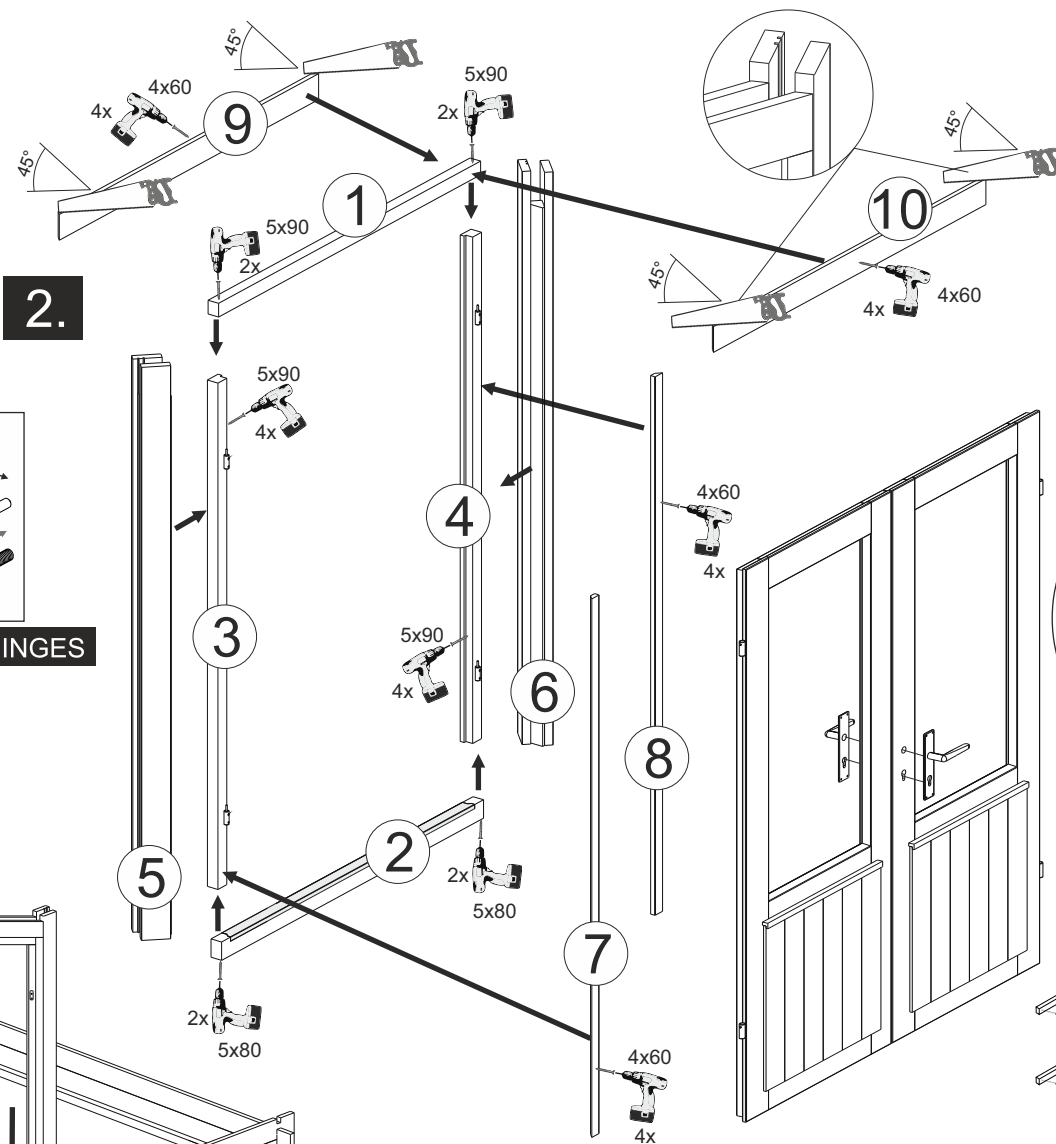

1. 2.

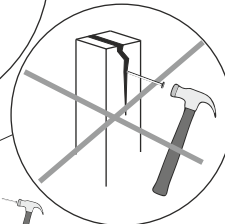



4.

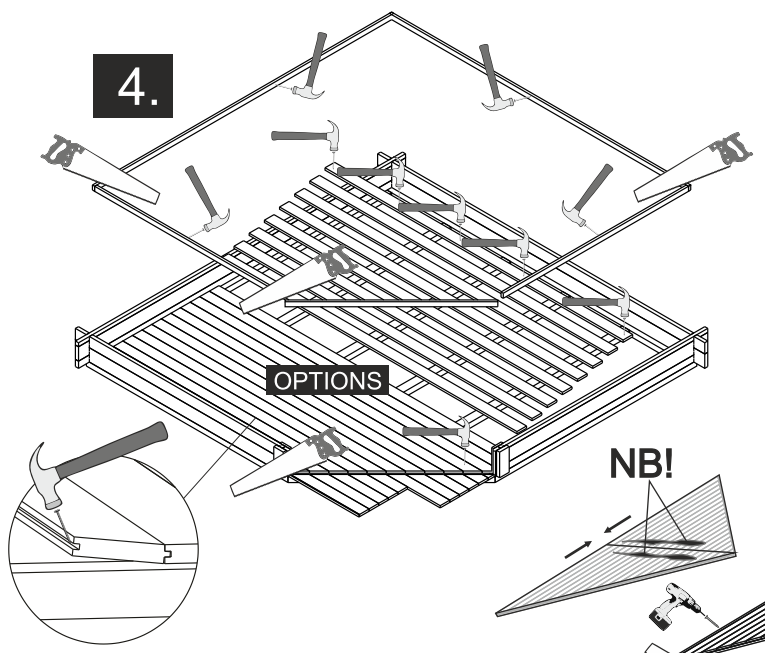

OPTIONS

NB!

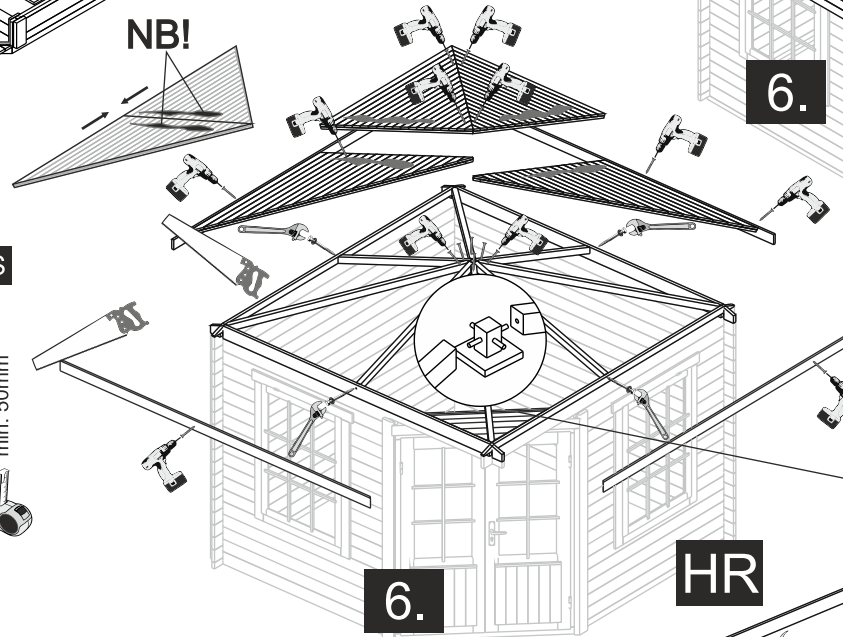

OPTIONS

6.

FR

OPTIONS- STORM BRACES

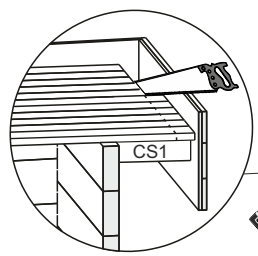
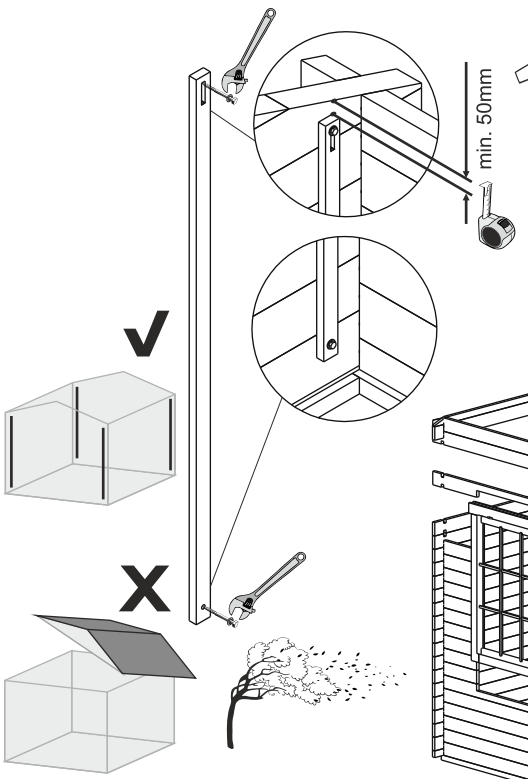

CS1

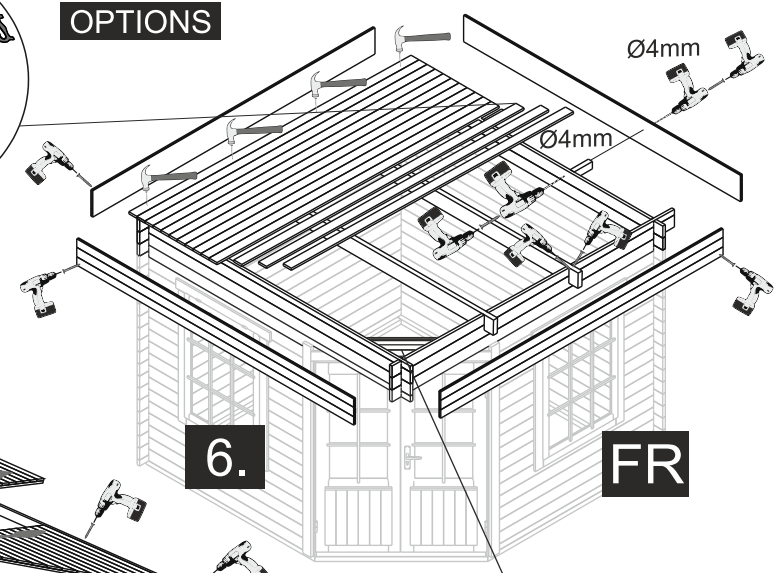

Ø4mm

Ø4mm

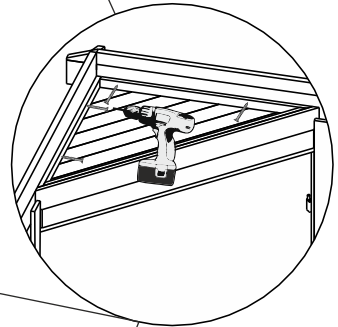

OPTIONS

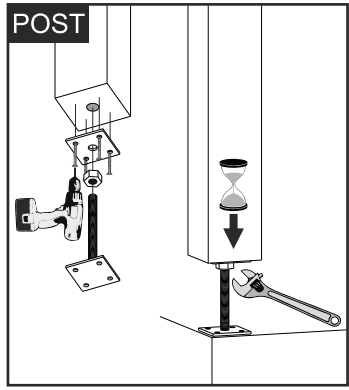
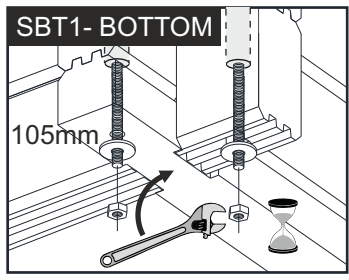
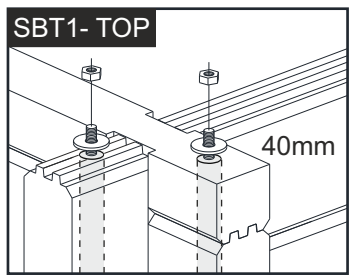
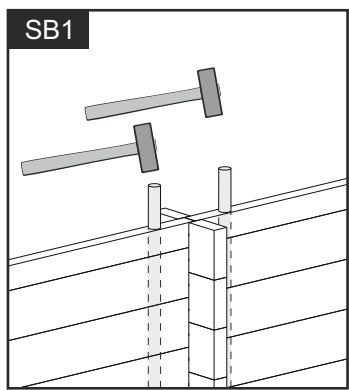

6.

HR

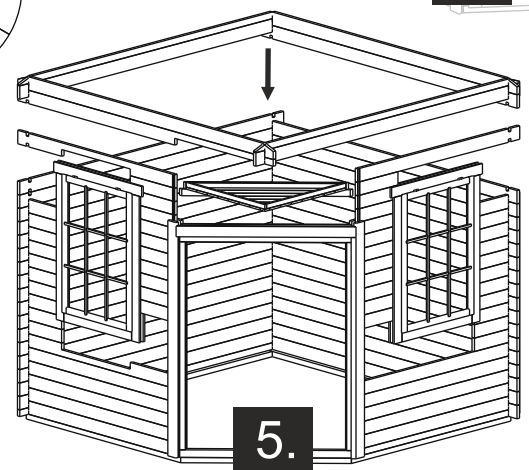

5.

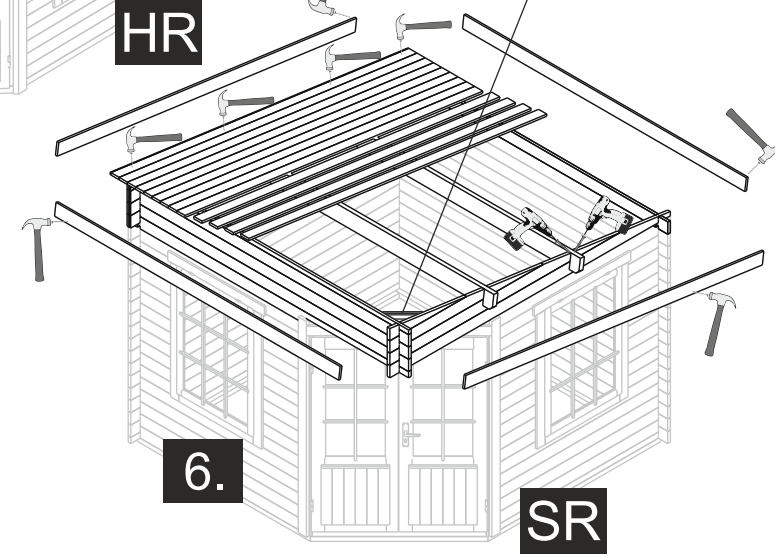

6.

SR